

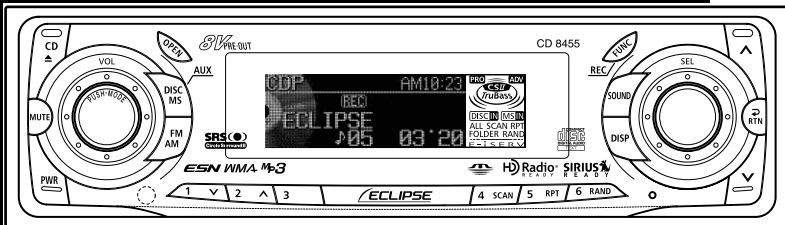

OWNER'S MANUAL



CD8455

ESN E8 High-Power "Pro Customize" CD/MS Receiver with MP3/WMA Decoder and Remote



We appreciate your purchase of this receiver.
Please read through this manual for correct operation.
We suggest that after reading it you keep this manual
in a safe place for future reference.

For your safety in using the CD8455

Warnings and caution signs, illustrated below, are posted throughout this manual as well as on the CD8455. They show safe and correct ways to handle the product so as to prevent personal injury to you, others and to avoid property damage.

Before reading through the manual, take time to read through and learn the important information listed in this section.



Warning

This sign indicates a situation in which incorrect handling or disregard of this sign might result in death or serious personal injury.



Caution

This sign indicates a situation in which incorrect handling or disregard of this sign might result in personal injury or may result solely in damage to property.

 **Warning**

- **Do not modify this system for use other than that specified herein. Also, do not deviate from the installation procedures described herein; Eclipse will not be held liable for damages including, but not limited to serious injury, death or property damage resulting from installations that enable unintended operation.**
- **This equipment requires 12V DC and should only be installed in a vehicle with a 12V negative ground electrical system. Any other installation may cause a fire or other severe damage to the equipment and the vehicle.**
- **Never install this equipment where it will interfere with safe operation of the vehicle. Never block the drivers' view. Do not install equipment where it may interfere with operation of the brakes, the steering or any safety equipment, including seat belts and air bags.**
- **Before drilling holes in a vehicle for installation, you must confirm the locations of pipes, tanks, electrical wiring, and other vehicle systems and components to ensure that there will be no interference or contact. In addition, you must also apply rust prevention and leak prevention measures at the drilling area. Otherwise, fire or electric shock could occur.**
- **When installing equipment do not remove or alter existing vehicle fasteners, including nuts, bolts, screws, clips, and fittings. Never detach, move or alter existing vehicle wiring, including electrical grounds and straps. Alteration of existing vehicle components may make vehicle unsafe to operate.**
- **Before installation, remove the negative (-) battery terminal to prevent shocks, electrical arcing, fires, and damage to vehicle wiring and the equipment you are installing.**
- **Secure wiring with tape or plastic ties so that wires do not interfere with vehicle operation, including brake pedal, gear shifter and steering. Position wires so that they will not be rubbed, abraded, or damaged by moving vehicle components, including power seats.**

 **Warning**

- To avoid equipment and vehicle damage, including fire, never supply power to installed equipment in a way which will overload the capacity of an existing vehicle circuit. Never leave a power supply wire or connection uninsulated. Always install supplied fuses, circuit breakers, and relays.
- Air bags are vital safety equipment. Never install equipment in a way which will alter air bag wiring or interfere with air bag deployment. Air bags must function properly in the event of an accident.
- When installation is complete, test all vehicle electrical systems for proper operation, including lights, horn, brake lights, and emergency flashers.
- For your protection, never use a power drill without safety glasses or goggles. Debris or broken drill bits may cause severe eye injuries, including blindness.
- Use electrical tape to insulate the ends of all wires, even if not used. Proper insulation prevents arcs, shocks and fires.
- Some equipment uses batteries. Never install equipment where young children can get access to batteries. If a battery is swallowed, seek medical attention immediately.
- When vehicle is moving, never take your eyes off the road to make adjustments to the equipment. You must pay attention to the road to avoid accidents, do not let the operation or adjustment of the equipment distract you from proper vehicle operation.
- The driver should not look at the screen while driving. Accidents may result if you are not paying attention to the forward direction.
- Do not put foreign objects in the loading slot of Memory Stick or disc. Fires or shocks may result.
- Do not disassemble or alter this equipment. Accidents, fires or shocks may result.
- Do not let water or foreign objects enter the internal parts of this equipment. Smoke, fires or shocks may result.
- Pay attention to where the remote control is left. Traffic accidents or problems with driving may result if the remote control makes its way under the foot pedals etc. when the vehicle is stopped or when it goes around a corner.



Warning

- Do not use when it is broken (the screen is not lit or no sound comes out). Accidents, fires or shocks may result.
- Always replace fuses with fuses of identical capacity and characteristics. Never use a higher capacity fuse than the original. Using the wrong type of fuse may cause a fire or severe damage.
- If foreign objects or water enters the equipment, smoke comes out, or there is a strange odor, stop using it immediately, and contact your dealer. Accidents, fires, or shocks may result if you continue to use it in these conditions.
- The driver should not change the Memory Stick or CD while driving. As accidents may result if you are not paying attention to the forward direction, first stop the car at a safe location and then proceed.
- Plastic bags and wrappings may cause suffocation and death. Keep away from babies and children. Never put bag over your head or mouth.



Caution

- **Wiring and installing this equipment requires expertise and experience. Professional installation is recommended. Consult with your dealer or a professional installer. Incorrect wiring may damage the equipment or interfere with safe vehicle operation.**
- **Use only the accessory parts as specified. Using other parts may cause damage to the equipment or cause parts to fall or fly off the equipment.**
- **Do not install the unit in places where it may get dew condensation on (around the air conditioning hose, etc.), come in contact with water, or in condition of high moisture, dust or oily smoke. If water, moisture, dust or oily smoke enters this unit, smoke, fires or malfunctions may result.**
- **Avoid installing in places where it cannot be fastened securely or where there are strong vibrations. Also, if you installed the unit with double-sided tape, first wipe away dirt and wax from the installation area. Otherwise, the unit may come loose due to vibration while driving, causing problems for driving and resulting in traffic accidents or injuries.**
- **Do not install in places with direct sunlight or where it will be hit directly by hot air from the heater. This may increase the temperature of the interior of this equipment, resulting in fires and malfunctions.**
- **Do not block the fan, heat sink or vents of this unit. When fan, heat sink or vent is blocked, the interior overheats, and fires may result.**
- **Connect as specified in the installation manual. If not connected normally, fires or accidents may result.**
- **When installing in vehicles equipped with air bags, check the manufacturer's cautions regarding operation before operating. Airbags may not operate properly.**
- **Carry out the wiring such that cords are not pinched by movable parts such as seat rails, and screw parts of the vehicle body. Accidents, fires and shocks may result from disconnection and electrical shorts.**
- **Carry out the wiring such that the cord does not make contact with metal parts. The cord maybe be damaged by contact with metal parts, resulting in fire and shocks.**



Caution

- **Avoid hot surfaces when wiring equipment. High temperatures may damage wiring, causing shorts, arcing and fires.**
- **When changing the installation location for this equipment, please consult the dealer where you bought it for safety reasons. Expertise is necessary for removal and installation.**
- **Keep volume to a reasonable level so that you can hear sounds from outside the vehicle, including warning sounds, voices, and sirens. Failure to do so may cause an accident.**
- **Be careful that hands and fingers are not pinched when adjusting the tilting angle or closing display. Injuries may result.**
- **Do not put your hands or fingers into the loading slot of Memory Stick or disc. Injuries may result.**
- **Do not touch the heat dissipating part of the amp. Burns may result from the heat of this part.**
- **Do not recharge dry batteries. Dry batteries may rupture, resulting in injuries.**
- **Do not use batteries other than those specified. Also, do not mix old and new batteries. Injuries or pollution to the surroundings may result from battery ruptures and leakage.**
- **When inserting batteries into the equipment, be careful with the polarity (positive/negative), and insert them as indicated. If the battery polarities are incorrect, injuries and pollution to the surroundings may result from battery ruptures and leakage.**
- **Replace used batteries as soon as possible; they may leak and damage equipment. Battery leakage can burn your skin or your eyes. Wash hands after handling.**
- **If alkaline solution from alkaline dry batteries makes contact with your skin or clothes, flush with clean water. If any of the solution gets in your eyes, also flush clean with water and then seek medical attention.**
- **When disposing of lithium dry batteries, affix insulating tape to the positive and negative terminals, and after they are insulated, dispose of them according to the "Local municipal ordinances". Shorts, fires and ruptures may result from disposal when coming contact with other electrically conductive objects such as metal parts, etc.**



Caution

- Do not short, disassemble or heat the batteries, or place them in fire or water. Fire and injuries may result from battery rupture and leakage.
- Store the remote control in a place away from direct sunlight, high temperatures, and high moisture levels. The case may change shape, and the batteries may rupture and leak.
- Do not use this equipment except for in-vehicle use. Shocks or injuries may result.
- Be careful of the position of the volume when turning the power source ON. Hearing damage may result if very loud noise is emitted when the power is turned ON.
- Do not operate under abnormal conditions such as when the sound is broken or distorted. Fires may result.
- This equipment uses invisible laser light. Do not disassemble or alter this equipment. If trouble occurs, contact the dealer where you bought the equipment.
Altering this equipment may cause exposure to laser emissions (worsening eyesight), or result in accidents, fires or shocks.
- If the equipment is dropped or the cosmetics appear broken, turn off the power to the main unit and contact your dealer. If used in this condition, fires or shocks may result.

Table of Contents

<i>Operating precautions</i>	16	I
<i>Names of controls and parts</i>	23	II
<i>ESN security operating procedure</i>	24	III
<i>Basic operation</i>	41	IV
<i>How to operate the CD player</i>	72	V
<i>How to operate the MP3/WMA player</i>	84	VI
<i>How to operate the Memory Stick player</i>	93	VII
<i>How to operate the tuner</i>	106	VIII
<i>How to operate the Sound Adjustment Mode</i>	119	IX
<i>How to operate the AREA SHOT function (U.S.A. only)</i>	173	X
<i>How to use the remote control</i>	184	XI
<i>How to operate the receiver with an optional CD changer connected</i>	192	XII
<i>How to operate the tuner with an optional HD RADIO tuner connected (U.S.A. only)</i> ...	196	XIII
<i>How to operate the tuner with an optional SIRIUS satellite radio tuner connected (U.S.A. only)</i> ...	203	XIV
<i>Others</i>	209	XV
<i>If you have a question:</i>	213	XVI
<i>Specifications</i>	218	XVII
<i>Before installation</i>	220	XVIII
<i>Mounting instruction</i>	221	XIX
<i>How to contact customer service</i>	234	XX

Table of Contents

Operating precautions.....	16
Notes on operation.....	16
About compact discs.....	17
About cleaning a CD.....	19
About Memory Sticks.....	20
About cleaning the Memory Sticks.....	22
Names of controls and parts	23
ESN security operating procedure.....	24
About ESN.....	24
How to switch the security type (Key CD security/Memory Stick security).....	25
How to operate the ESN (Key CD) security.....	26
How to program the Key CD.....	26
How to cancel the Key CD.....	27
How to change the Key CD.....	28
How to resume normal operation (ESN security lock out).....	28
What happens if an incorrect CD is inserted?.....	29
How to operate the ESN (Memory Stick) security.....	30
How to record a security code.....	30
How to cancel the Memory Stick security.....	32
How to change the Memory Stick.....	34
How to resume normal operation (ESN security lock out).....	35
What happens if a Memory Stick or security code is incorrect?.....	37
How to operate the ACC security.....	38
How to turn the security indicator on/off.....	39
How to read the Electronic Serial Number.....	40
Basic operation.....	41
Turning the power on and off.....	41
Listening to CD.....	42
Listening to MG Memory Stick.....	43
Listening to the tuner.....	44
Adjusting audio volume.....	45
Switching audio control modes.....	46
VOL (VOLUME) Mode.....	46
BASS Mode.....	46
MID (MIDDLE) Mode.....	47
TREB (TREBLE) Mode.....	47
BAL (BALANCE) Mode.....	47
FAD (FADER) Mode.....	47
NON-F (NON-FADER) Mode.....	47
SVC (Source Volume Control) Mode.....	48

Enabling the loudness control	49
Making changes with Display Adjustment Mode.....	50
Switching the motion picture.....	51
Switching the brightness.....	52
Changing illumination color.....	53
Disabling the display.....	54
Importing DISP screens.....	55
Displaying Amplifier Status (E-AMP DISP).....	58
Making changes with Function Mode.....	59
Disabling the guide tone feature (for button operation)	61
Clock display on/off.....	62
Setting the time.....	63
Switching demonstration screen display.....	64
Setting the steering switch function (U.S.A. only).....	65
Others	69
Operation assist function	69
Displaying a memo	70
Setting a memo.....	70
Deleting a memo.....	71

How to operate the CD player..... 72

Listening to CDs.....	72
Advancing to the next track or returning to the beginning of the track being played	73
Fast Forward/Rewind.....	73
Playing the beginning of tracks (SCAN).....	73
Repeating the same track (REPEAT)	74
Playing tracks in random order (RANDOM).....	74
Switching a CD to pause / play	75
Ejecting the disc.....	75
Creating a title for a CD	76
Changing a previously set title	78
Deleting a previously created title	80
Changing the number of CD titles	81
Displaying CD text	83

How to operate the MP3/WMA player..... 84

About MP3/WMA	84
What is MP3/WMA?.....	84
Playable MP3 file standards	84
Playable WMA file standards.....	84
ID3/WMA tags.....	85
Media	85
Format of discs	86
File names	87
Multi-sessions	87
Playing MP3/WMA.....	87

MP3/WMA playing time display	87
Display order of MP3/WMA file/folder names	87
Listening to MP3/WMA file	88
Advancing to the next track (file) or returning to the beginning of the track (file) being played	89
Skipping to the next or previous folder	89
Fast Forward/Rewind	89
Return to the root directory of the CD	89
Playing the beginning of files (SCAN)	90
Repeating the same file (REPEAT)	90
Playing files in random order (RANDOM)	91
Displaying title	92

How to operate the Memory Stick player..... 93

Listening to MG Memory Stick	93
Advancing to the next track or returning to the beginning of the track being played	94
Fast Forward/Rewind	94
Playing the beginning of tracks (SCAN)	94
Repeating the same track (REPEAT)	95
Playing tracks in random order (RANDOM)	95
Ejecting the Memory Stick	96
Recording on Memory Stick	97
Selecting tracks to be recorded	99
Setting sound quality	100
Deleting recorded file	102
Formatting MG Memory Stick (quick format)	104

How to operate the tuner..... 106

Tuning to a station	106
Entering stations into memory automatically	
(The automatic preset mode: ASM)	107
Manually setting stations into memory	108
Preset station scan	109
Setting a station name	110
Deleting a station name	112
Changing the number of bands	113
Changing the reception sensitivity for automatic scanning	115
Changing the radio band location	116
FM reception characteristics	117
FM reception differs from AM	117
Fading out	117
Reception area of FM broadcasts	118
Multipath	118

How to operate the Sound Adjustment Mode 119

About Sound Adjustment Mode	119
SRS Circle Surround II (CS II)	120
Parametric equalizer	120
Time Alignment	122
Crossover	123
Multi-harmonizer	125
Non-fader phase	125
Non-Fader output	125
Speaker layout	125
E-iSERV sound effect customizations	125
Operations during Normal Mode	128
SRS Circle Surround II (CS II)	129
Parametric equalizer adjustment (PEQ)	130
Selecting an equalizer mode from memory	132
Measuring/display frequency characteristic	133
Simplified time alignment settings (Time Alignment)	136
Crossover adjustment (X-Over)	142
Multi-harmonizer settings (Harmonizer)	143
Non-fader phase selection (NON-F Phase)	144
Non-Fader Output	145
Importing Sound Data	146
Operations during Pro Mode	148
Parametric equalizer adjustment (PEQ)	150
Selecting an equalizer mode from memory	157
Measuring/display frequency characteristic	158
Time alignment adjustment (Time Alignment)	161
Crossover adjustment (X-Over)	163
Multi-harmonizer settings (Harmonizer)	166
Non-fader phase selection (NON-F Phase)	167
Non-Fader Output	168
Speaker layout	169
Importing Sound Data	170
Custom Mode	172

How to operate the AREA SHOT function (U.S.A. only) 173

About the AREA SHOT	173
To use the AREA SHOT function	174
Map data	175
GPS (Global Positioning System)	175
Reading the AREA SHOT data	176
Changing the AREA SHOT mode	178
Using the AREA SHOT mode	179
AREA SHOT Screen Configuration	179
Switching between guidance points	180
Re-scrolling through text information	181

Changing AREA SHOT screens	182
Display Arrows	183
<i>How to use the remote control</i>	184
Precautions in use of the remote control	184
Cleaning the remote control	184
Turning the power on/off	185
Adjusting the audio volume	185
Muting the volume	185
Switching playback modes	186
How to play the tuner	186
Selecting the FM/AM band	186
Selecting a station (manually or automatically)	187
Selecting preset stations	187
How to play CDs	187
Switching disc modes	187
Advancing to the next track or returning to the beginning of the track being played	188
Skipping to the next or previous disc	188
How to play MP3/WMA	189
Switching disc modes	189
Advancing to the next file or returning to the beginning of the file being played ..	189
Skipping to the next or previous folder	189
Replacing the battery	190
<i>How to operate the receiver with an optional CD changer connected</i>	192
Switching the input channel	192
Listening to a CD	192
Advancing to the next track or returning to the beginning of the track being played ..	192
Fast Forward/Rewind	193
Playing the beginning of tracks (SCAN)	193
Repeating the same track (REPEAT)	194
Playing tracks in random order (RANDOM)	194
Skipping to the next or previous CD	195
Specifying a CD to play	195
<i>How to operate the tuner with an optional HD Radio tuner connected (U.S.A. only)</i>	196
About HD Radio	196
Tuning to a station	197
Entering stations into memory automatically (The automatic preset mode: ASM)	198
Manually setting stations into memory	199
Preset station scan	200

Switching between displays when receiving HD Radio.....	201
HD Radio reception settings	201
<i>How to operate the tuner with an optional SIRIUS satellite radio tuner connected (U.S.A. only).....</i>	203
About SIRIUS satellite radio	203
Selecting the radio mode	204
Selecting a channel.....	204
Category selection	205
Direct Channel selection	205
Manually setting channels into memory.....	207
Preset channel scan	208
Switching displays when using the SIRIUS satellite radio	208
<i>Others</i>	209
Connecting portable audio players to the AUX jack.....	209
Switching the external input method (analog/digital).....	210
Changing auxiliary input sensitivity.....	211
User Registration Key display	212
<i>If you have a question:</i>	213
Displayed information (for troubleshooting)	214
<i>Specifications.....</i>	218
<i>Before installation.....</i>	220
Components.....	220
Installation angle	220
<i>Mounting instruction</i>	221
Mounting the main unit.....	221
Names of lead wires and destinations	224
Measuring the frequency characteristics inside the passenger compartment	226
System	227
<i>How to contact customer service.....</i>	234

Operating precautions

<Your CD8455 will perform well over a long period of time through correct handling and care.>

Notes on operation

- For your safety, play only at volume levels that allow outside sounds to be heard.



- We recommend using with this player a disc with the logo shown to the left.
- You can play music CDs (CD-R/CD-RW) on this player. Be sure to use discs that have been properly processed. Depending on the editing equipment used, some discs may not play properly.

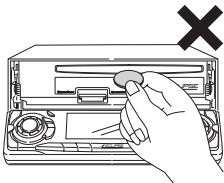

- Do not insert anything other than a CD and a Memory Stick into the head unit. Do not insert any foreign objects, such as coins or credit cards, into the disc slot. Be especially watchful of children's mischief in this regard.



- Avoid severe mechanical shock. When the player is subjected to severe vibration while traveling over a rough surface, playback may be intermittent. When a situation like this occurs, resume playback after returning to a smoother road.



- About dew condensation. In cold or rainy weather, just as the interior glass surface gets fogged, dew (water condensation) may also settle on the deck. When this occurs, disc playback may become intermittent or impossible. Dehumidify the air in the vehicle for a while before resuming playback.

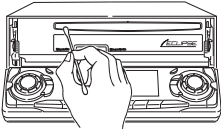

- **Cleaning the disc slot.**
The disc slot tends to get dusty. Clean it occasionally to prevent accumulated dust from scratching the discs.
- **With the front panel open, many functions will not operate, therefore, the front panel will need to be closed during operation.**

About compact discs

- The signal recorded on a compact disc is read by a laser beam, so nothing touches the disc surface. A scratch on the recorded surface or a badly warped disc may cause deteriorated sound quality or intermittent playback. Observe the following precautions to ensure high quality sound performance:

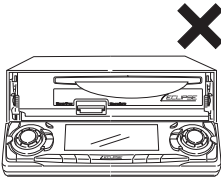

- **Do not leave an ejected disc in the disc slot for very long; the disc may warp. Discs should be stored in their cases and kept away from high temperature and humidity.**

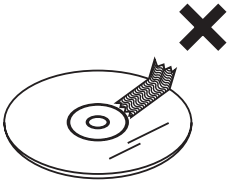

- **Do not stick a piece of paper or tape. Do not write on or scratch either side of a disc.**



- **Discs spin at a high speed inside the deck. Keep cracked or warped discs out of the player to avoid damage it.**

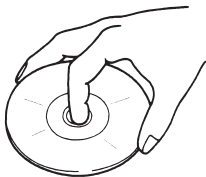

- **Avoid touching the recorded surface when handling a disc; handle discs by their edges.**

About brand new CDs

- You may notice that some brand new discs are rough around the center hole or outside edge. Remove the rough edges with the side of a ballpoint pen, etc. Rough edges may prevent proper loading in the deck. Flakes from the rough edges may also stick to the recorded surface and interfere with playback.

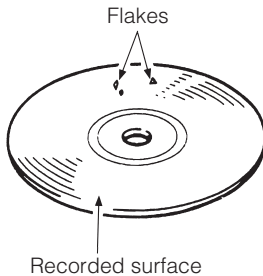
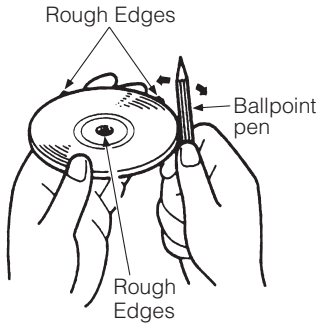

About CD accessories

- Do not use accessories (stabilizers, protective seals, laser lens cleaners, etc.) sold for "improving sound performance" or "protecting CDs." The changes in CD thickness or outside dimensions made by these accessories may cause problems in the player.

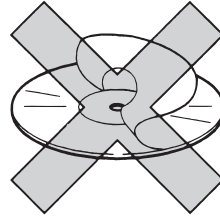

- Please be sure NOT to attach any ring-shape protector (or other accessory) to your discs. Those protectors are commercially available and said to protect disc and to improve sound quality (and antivibration effect), but they can do more harm than good in regular uses. The most common problems are disc insertion, disc ejections, and won't play problems due to the protector ring that came off in the disc mechanism.

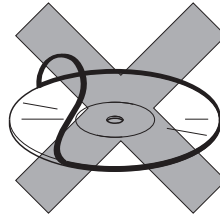

About borrowed CDs

- Do not use a CD with glue or remnants of adhesive tape or labels. They may cause the CD to get stuck inside or damage the deck.

How to remove CDs

- When removing the ejected disc, pull it straight out along the slot. Pressing downward in the process may scratch the recorded surface of the disc.

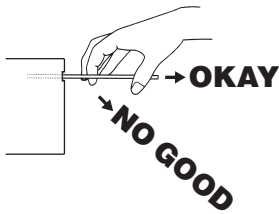

About irregularly-shaped CDs

- Specially-shaped CDs, like heart-shaped or octagonal CDs, cannot be played. Do not attempt to play them, even with an adapter, since they may damage the player.

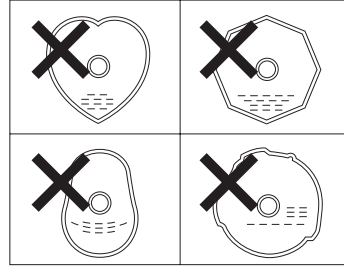

About cleaning a CD





- Use a commercially available compact disc cleaner to clean a CD, wiping gently from the center to the edge.



- Do not use benzine, thinner, LP record spray or other cleaners on CDs. They may damage a CD's finish.

About Memory Sticks

- Do not store Memory Sticks in places that are subject to static electricity and electrical interference, otherwise the data they contain may become corrupted.
 - In order to protect the player, the player's functions will be stopped automatically if a problem occurs. If the player cannot be operated even after following the instructions that appear on the screen, the unit is malfunctioning, and you should ask the place of purchase for further advice.
 - If using a Memory Stick Duo, you will need to use it with a Memory Stick Duo adapter.
 - Only Memory Sticks with a capacity of up to 128 MB can be used in the unit.
 - Memory Stick PRO types of Memory Stick cannot be used.
 - If MG Memory Stick is not being used for prolonged time, remove it from the unit.
 - MG Memory Sticks bearing one of the marks at the left can be used.
 - Memory Sticks bearing one of the marks at left can be used for writing and reading data other than music data.
- MagicGate Memory Stick  and Memory Stick  are trademarks of Sony Corporation.
- If the write protection switch on a MG Memory Stick or Memory Stick is at the lock position, audio recordings and other data cannot be saved onto it.
 - Do not remove a MG Memory Stick while it is being accessed for playback or recording, otherwise the data on the MG Memory Stick may become corrupted. If the data becomes corrupted, it can no longer be retrieved.
 - Please format the MG Memory Stick on this deck. A MG Memory Stick formatted by another deck may not be playback or record data.
 - When a Memory Stick is formatted, all data on that Memory Stick will be erased. (Includes Memory Stick security recorded data and sound quality data)

MAGICGATE



- MG Memory Stick supplied is not formatted. MG Memory Stick must be formatted prior to use. Refer to "Formatting MG Memory Stick (quick format)" on page 104 for instructions on formatting MG Memory Sticks.
- It may not be possible to use MG Memory Sticks that have just been purchased. If this happens, use the unit to format the MG Memory Stick. Refer to "Formatting MG Memory Stick (quick format)" on page 104 for instructions on formatting MG Memory Sticks.
- Some recordings and other data may not be played back or written/read, depending on the device that was used to save the data.
- Do not use Memory Sticks with labels that are peeling off or that have name tags (labels) attached.

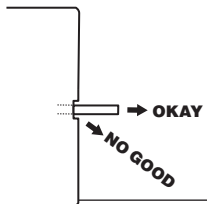
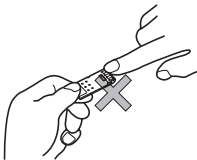
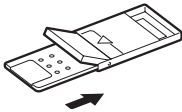
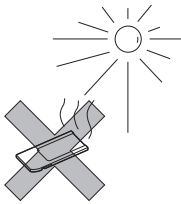

- Store Memory Sticks in places away from direct sunlight and high humidity, otherwise the Memory Sticks may become unusable.
- Place Memory Sticks in their protective cases during transportation and storage.
- Do not touch the terminals with your hands or with metallic objects.
- When removing the ejected Memory Stick, pull it straight out along the slot. Pressing downward in the process may scratch the recorded surface of the Memory Stick.

About cleaning the Memory Sticks

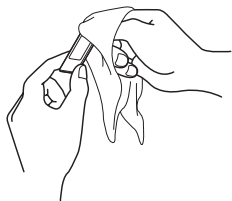

- In order to maintain good audio performance from Memory Sticks, periodically wipe the cartridge clean of any dust and other contamination with a dry cloth.

Names of controls and parts

Front view

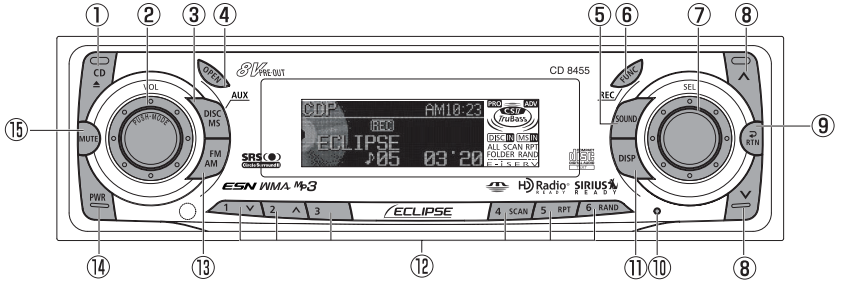

With the front open

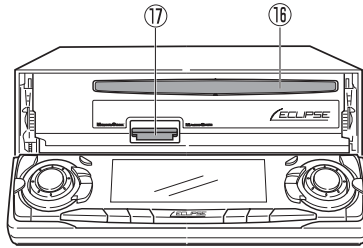

Never place an object or rest your hands or the like on the front panel.

①	[CD ▲] button	Opens/closes front panel and ejects CD.
②	[AUDIO CONTROL] button	Adjusts volume and performs other functions.
③	[DISC MS] button	Switches disc modes, Memory Stick mode and switches to AUX mode.
④	[OPEN] button	Opens/closes front panel.
⑤	[SOUND] button	Turns the sound adjustment mode ON/OFF.
⑥	[FUNC] button	Turns function mode ON/OFF.
⑦	[SEL] button	Selects radio stations and CD tracks.
⑧	[^ / v] button	Automatically finds radio reception or to fast forward/rewind.
⑨	[RTN] button	Returns to previous screen.
⑩	[RESET] button	Reset deck functions to default settings.
⑪	[DISP] button	Turns the display adjustment mode ON/OFF and switches screen display. Displays User Registration Key.
⑫	Buttons [1] to [6]	Selects radio preset channels and performs disc mode functions.
⑬	[FM AM] button	Switches to radio mode and switches radio bands.
⑭	[PWR] button	Turns deck power ON/OFF.
⑮	[MUTE] button*	Activates and deactivates mute.
⑯	Disc slot	Inserts compact discs.
⑰	Memory Stick slot	Inserts and ejects Memory Stick.

*: Double function button → "MUTE" & "AREA SHOT" functions

ESN security operating procedure

About ESN

This deck is equipped with ESN (ECLIPSE Security Network). A pre-registered music CD (Key CD), four-digit security code, or a Memory Stick on which all unit functions will not operate, even by turning the ignition switch to the ACC or ON position or reconnecting the battery after turning the ignition switch off or disconnecting the battery during maintenance.

ESN can be set or cancelled using any of the following methods:

- **Key CD security (See page 26)**

You can record a specific CD that you have as a "key CD" with the deck, and this CD can then be used to set and cancel the security settings.

- **Memory Stick security (See page 30)**

You can record a Memory Stick and a secret code (security code) with the deck, and this Memory Stick or secret code (security code) can then be matched with the deck to set and cancel the security settings.

- **ACC security (See page 38)**

This method can only be used when Memory Stick security has already been set. When ACC security is set, button operations are disabled when the ignition switch is turned to OFF and then back to ACC.

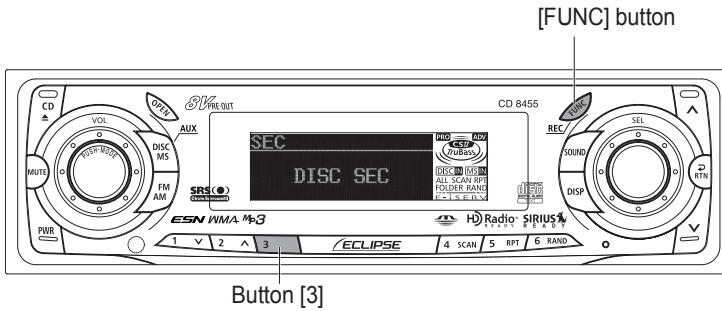

How to switch the security type (Key CD security/ Memory Stick security)

You can switch the type of security being used (Key CD security or Memory Stick security). The initial setting is for Key CD security to be used.

- 1** Check that the unit is in standby.
- 2** Press and hold the [FUNC] button, then button [3], and hold both for the more than two seconds.

Security type will switch from Key CD security (DISC SEC) ↔ Memory Stick security (MS SEC) in order each time the button is pressed.



If a security is activated, switching the security type is not available.

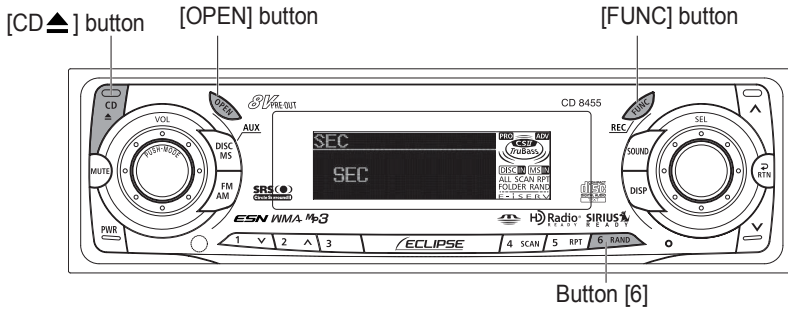

Button [6]

How to operate the ESN (Key CD) security

How to program the Key CD

- 1** Check that the unit is in standby.
- 2** Press and hold the [FUNC] button, then button [6], and hold both for more than one second.
A [SEC] message appears, in two seconds it will change to [DISC].



ATTENTION

- If a CD has already been inserted, a [SEC] message appears, and then the front panel opens and the CD is ejected.
- If a security is activated, programming the Key CD is not available.

- 3** Press the [OPEN] or [CD ▲] button.
The front panel opens; The CD8455 is now ready for your Key CD in the CD slot.
- 4** Insert the CD into the slot.
A [SEC] message appears, then the Key CD is ejected.
- 5** Press the [OPEN] or [CD ▲] button.
The front panel closes.



- If there is a problem with the inserted CD, an [ERR] message will appear for two seconds and the CD will be ejected. Reinsert the ejected CD.
- If a CD causes the [ERR] message to appear twice in a row, a [CHANGE] message will appear for two seconds. Try another CD.
- Copy Protected CD and MP3/WMA CD-ROM cannot be programmed for Key CD security.
- The Security indicator will flash whenever the vehicle's ignition is switched off.

How to cancel the Key CD

- 1 Check that the unit is in standby.**
- 2 Press and hold the [FUNC] button, then button [6], and hold both for more than one second.**
A [SEC] message appears, then in two seconds it will change to [DISC].
- 3 Press the [OPEN] or [CD▲] button.**
The front panel opens; The CD8455 is now ready for your Key CD in the CD slot.



If a CD has already been inserted, a [SEC] message appears, and then the front panel opens and the CD is ejected.

- 4 Insert your Key CD into the slot.**
A [CANCEL] message appears, then the Key CD is ejected. The Key CD is cancelled.



- This process cancels the protection for ESN deck.
- If power to the ESN deck is disconnected, then reconnected, a Key CD will not need to be inserted in order to return the unit to normal operation.
- Inserting a CD other than the Key CD will not cancel the protection. Instead, the display [ERR] for two seconds, then the normal CD playback mode will activate.

- 5 Press the [OPEN] or [CD▲] button.**
The front panel closes.

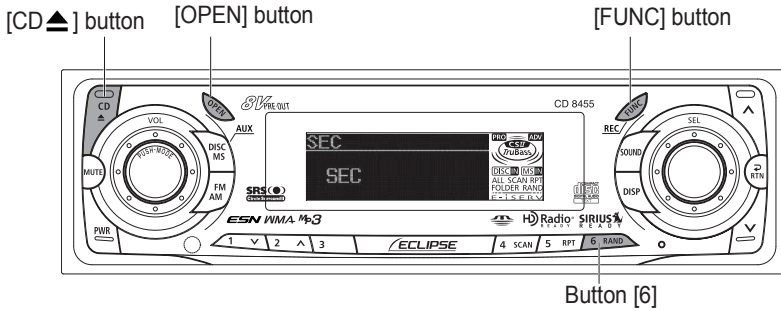

How to change the Key CD

- 1 First, cancel the existing Key CD.**
Refer to "How to cancel the key CD".
- 2 Next, program a new Key CD.**
Refer to "How to program the Key CD".

How to resume normal operation (ESN security lock out)

If power is disconnected while ESN security is active (a Key CD was programmed), operation is disabled until power is restored and the unit unlocked. Follow this procedure to resume normal operation.

- 1 When the power is turned on after disconnecting the battery power, a [SEC] message will appear for two seconds. Thereafter, message changes to [DISC] and the press the [OPEN] or [CD ▲] button, then the CD8455 is ready to accept your Key CD into the slot.**
- 2 Insert your Key CD.**
If the correct CD is inserted, an [OK] message will appear for two seconds and the CD will begin playing.



- If the incorrect CD is inserted, an [ERR_] ("ERR" and error number) message will appear for two seconds, after which the CD will be ejected.
- If [ERR5] (the 5th time an error has occurred) appears, [HELP] will appear, after which the CD will be ejected. When [HELP] appears, carry out the operations for an ESN security lock out by following the procedure in "What happens if an incorrect CD is inserted?" on page 29.
- You must use the same CD used for Key CD programming; a duplicate CD may not work properly.

What happens if an incorrect CD is inserted?

- 1 After the 5th incorrect attempt, the display reads [HELP] for five seconds.**

After the [HELP] message will appear for five seconds, serial number will appear.

- 2 Press the [OPEN] or [CD▲] button to close the front panel.**

- 3 Press the [FUNC] button, then button [6], and hold them for five seconds.**

After the [SEC] message will appear for two seconds, rolling code (six digit) will appear.

- 4 Press the [FUNC] button.**

A [DISC] message appears.

You will have five more attempts the to insert correct disc.

- 5 Insert the key CD into the slot.**

If the correct CD is inserted, an [OK] message will appear for two seconds and the CD will be ejected.



ATTENTION

- If an incorrect CD is inserted, an [ERR_] ("ERR" and error number) message will appear for two seconds, after which the CD will be ejected.
- This process cancels the protection for ESN deck.

● Note ●

If after 5 tries the correct Key CD is not inserted, the display reads [CALL800]; the unit must be returned to Eclipse to be reset. In this case, please contact your Eclipse dealer for assistance. For country-specific customer service information, refer to "How to contact customer service" on page 234.

Your Key CD can be easily forgotten. Write the album name in a reminder note (See page 237).

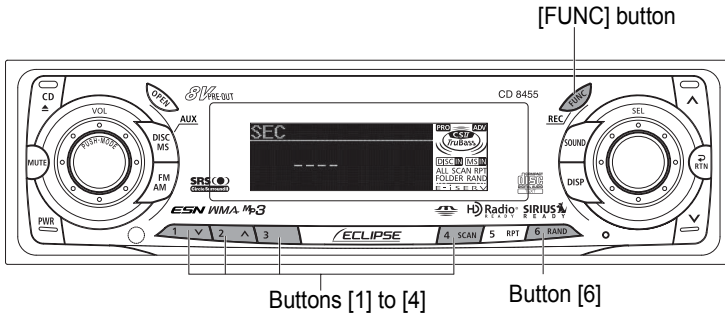

How to operate the ESN (Memory Stick) security

How to record a security code

- 1 Check that the unit is in standby.**
- 2 Press and hold button [1], then the [FUNC] button, and hold both for more than one second.**

A [SEC] message appears, in two seconds it will change to [MS].



ATTENTION

- If a Memory Stick has already been inserted, a [MS EJECT] message appears. In this case, eject the Memory Stick and insert again. (Refer to "Ejecting the Memory Stick" on page 96 for details on ejection of the Memory Stick.)
- If the security is already activated, recording the security code function is not available.

- 3 Insert the Memory Stick into the slot.**

A [- - -] (security code input display) appears.

(Refer to "Listening to MG Memory Stick" on page 43 for details on insertion of the Memory Stick.)

- 4 Input a security code by pressing buttons [1] to [4].**

Enter a four-digit security code using digits 0 to 9, A to F. The number (shown on the display) changes in ascending order between 0 and 9, A and F each time the button is pressed. Each button number (1 to 4) corresponds to each digit (first to fourth) of the security code.

5 Press the [FUNC] button for more than one second.

The security code is registered in the deck and security is set. The registered security code is encrypted and then written to Memory Stick.



When the security code is registered using a Memory Stick that contains several kinds of data, such as music, etc., be careful not to clear the recorded data by formatting the Memory Stick.

6 Eject the Memory Stick.

Refer to "Ejecting the Memory Stick" on page 96.



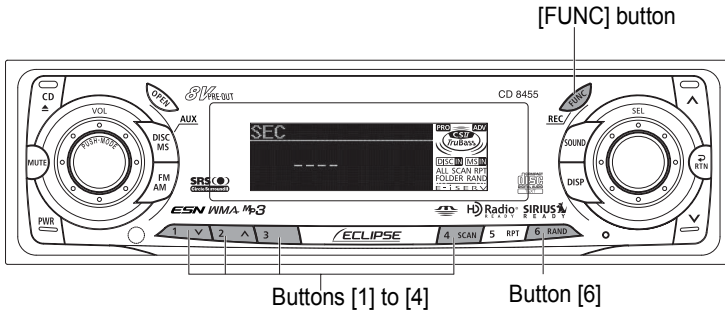

How to cancel the Memory Stick security

The security function can be canceled when the security code that has been recorded with the deck is entered and verified. Canceling the security function can be done by entering the security code into the deck, or by using the Memory Stick.

Canceling the security function by entering the security code

- 1 Check that the unit is in standby.**
- 2 Press and hold button [1], then the [FUNC] button, and hold both for more than one second.**

A [SEC] message appears, then in two seconds it will change to [- - -] (Security code input display).

- 3 A security code is entered by pressing the buttons [1] to [4].**

Enter a four-digit security code using digits 0 to 9, A to F. The number (shown on the display) changes in ascending order between 0 and 9, A and F each time the button is pressed. Each button number (1 to 4) corresponds to each digit (first to fourth) of the security code.

- 4 Press the [FUNC] button.**

If a security code is entered and the deck verifies that it is correct, [CANCEL] will appear on the display and the security function will be canceled.



ATTENTION

If the security code that is entered does not match the code that is recorded by the deck, [ERR] will appear on the display for two seconds and operation will continue as normal without the security function being canceled.

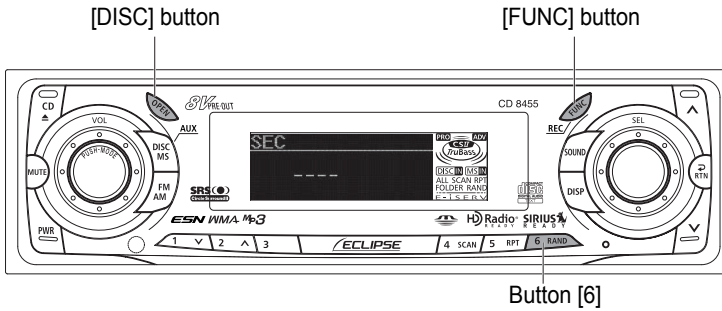

Canceling the security function using a Memory Stick

- 1** Check that the unit is in standby.
- 2** Press and hold button [1], then the [FUNC] button, and hold both for more than one second.

A [SEC] message appears, then in two seconds it will change to [- - -] (Security code input display).

- 3** Press the [DISC] button.

A [MS] message will appear.



ATTENTION

If a Memory Stick has already been inserted, a [MS EJECT] message appears. In this case, eject the Memory Stick and insert again. (Refer to "Ejecting the Memory Stick" on page 96 for details on ejection of the Memory Stick.)

- 4** Insert the Memory Stick and close the front panel.
The recorded data will be read from the Memory Stick.
- 5** If the contents recorded in the Memory Stick match the information recorded by the deck, [CANCEL] will appear on the display.

The security function will be canceled and the deck will return to normal operation.



ATTENTION

- If a reading error occurs or if an incorrect Memory Stick is inserted, [ERR] will appear on the display for two seconds, and then the display will change to [EJECT]. If this happens, eject the Memory Stick and try again.
- Security setting cannot be canceled by this procedure if the Memory Stick containing the security code is formatted.

- 6** Eject the Memory Stick.

Refer to "Ejecting the Memory Stick" on page 96.

How to change the Memory Stick

You can change the Memory Stick and security code that have been recorded by the deck to a different Memory Stick and security code.

1 Cancel the security code that has been recorded with the deck.

Refer to "How to cancel the Memory Stick security" on page 32.

2 Re-record the new Memory Stick and security code that you would like to use.

Refer to "How to record a security code" on page 30.

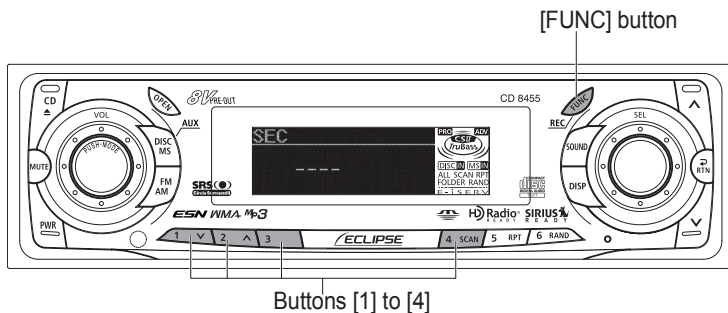

How to resume normal operation (ESN security lock out)

If power is disconnected while ESN security is active (a security code was recorded), operation is disabled until power is restored and the unit unlocked. Follow this procedure to resume normal operation.

ESN security lock can be canceled by directly entering the security code into the deck, or by using the Memory Stick that was being used when the security code was recorded.

Canceling ESN security lock out using security code entry

- 1** When the power is turned on after disconnecting the battery power, a [SEC] message will appear for two seconds. Thereafter, message changes to [- - -] (Security code input display).
- 2** A security code is entered by pressing the buttons [1] to [4].

Enter a four-digit security code using digits 0 to 9, A to F. The number (shown on the display) changes in ascending order between 0 and 9, A and F each time the button is pressed. Each button number (1 to 4) corresponds to each digit (first to fourth) of the security code.

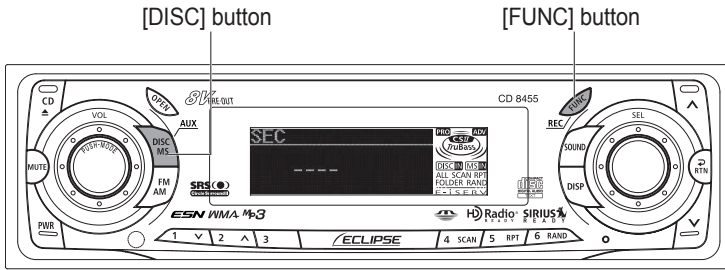

3 Press the [FUNC] button for more than one second.

If the security code matches the code recorded by the deck, [OK] will appear on the display and the security function will be canceled.



- If the security code does not match the information recorded by the deck, [ERR_] (ERR and the error number) will appear on the display for two seconds, and then [- - -] (security code entry display) will appear. If this happens, check the security code and repeat the procedure from step 2.
- If [ERR5] (the 5th time an error has occurred) appears, [HELP] will appear. When [HELP] appears, carry out the operations for an ESN security lock out by following the procedure in "What happens if a Memory Stick or security code is incorrect?" on page 37.

Canceling ESN security lock using Memory Stick

1 After the battery is connected and the deck's power is turned on, [SEC] will appear on the display for two seconds. After this, [- - -] (security code entry display) will appear.

2 Press the [DISC] button.

[MS] will appear on the display. If you press the [DISC] button once more, the display will return to [----] (security code entry display).



If a Memory Stick has already been inserted, a [MS EJECT] message appears. In this case, eject the Memory Stick and insert again. (Refer to "Ejecting the Memory Stick" on page 96 for details on ejection of the Memory Stick.)

3 Insert the Memory Stick that has been recorded, and then close the front panel.

The recorded data will be read from the Memory Stick.

- 4 If the contents recorded in the Memory Stick match the information recorded by the deck, [OK] will appear on the display for two seconds, and then the deck will return to normal operation.**



- If the contents recorded in the Memory Stick do not match the information recorded by the deck, [ERR_] (ERR and the error number) will appear on the display for two seconds, and then [- - -] (security code entry display) will appear. If this happens, check the Memory Stick and repeat the procedure from step 2.
- If [ERR5] (the 5th time an error has occurred) appears, [HELP] will appear. When [HELP] appears, carry out the operations for an ESN security lock out by following the procedure in "What happens if a Memory Stick or security code is incorrect?" on page 37.
- ESN security lock cannot be canceled by this procedure if the Memory Stick containing the security code was formatted.

What happens if a Memory Stick or security code is incorrect?

- 1 After the 5th incorrect attempt, the display reads [HELP] for five seconds.**

After the [HELP] message was displayed for five seconds, serial number will appear.

You will only get 5 unsuccessful unlock code entries. After the 5th attempt, you will be asked to insert the DISC (Key CD). At this point, please contact your local Eclipse dealer or Eclipse Customer Service for procedure on unlocking the unit.

● Note ●

For country-specific customer service information, refer to "How to contact customer service" on page 234.

Your security code and Memory Stick can be easily forgotten. Write the security code and Memory Stick title in a reminder note (See page 237).

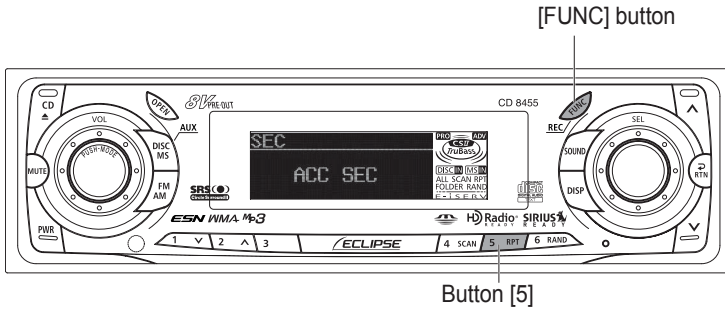

How to operate the ACC security

ACC security involves using Memory Stick security to record a security code, and then when the ignition switch is turned to OFF and back to ACC, the operation of all buttons is disabled.

- 1** Check that the unit is in standby.
- 2** Once a security code has been recorded, press the [FUNC] button and button [5] simultaneously for more than two seconds.

The ACC security function will be activated. Press the [FUNC] button and button [5] simultaneously for two seconds or more again to cancel the ACC security function.



ATTENTION

- If the vehicle's battery is disconnected at times such as during servicing, ACC security will be canceled.
- When ignition switch is turned OFF and back to ACC, the operation all button is disabled. If this happen, resume normal operation. (Refer to "How to resume normal operation (ESN security lock out)" on page 35.)

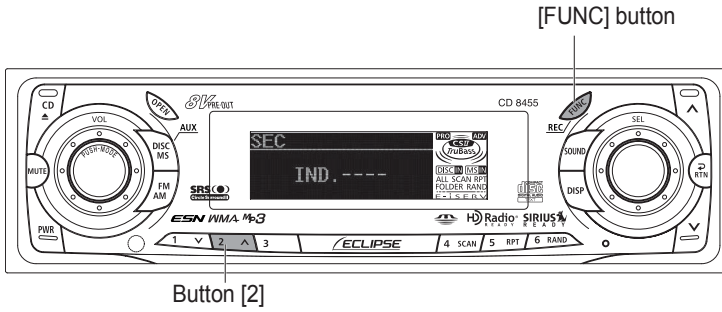

How to turn the security indicator on/off

Once ESN security is activated, the indicator flashes whenever the vehicle's ignition switch is turned off, warning potential thieves that the unit is protected. However, if do not want this visible deterrent, it may be turned off.

- 1** With the unit in standby, press the [FUNC] button, then button [2] and hold both for more than one second.
- 2** [IND. FLASH] or [IND.----] appears on the display.

[IND. FLASH] means the security indicator will flash when the vehicle's ignition switch is off, and [IND.----] means it will not. Repeat the above steps to reactivate the flash mode.

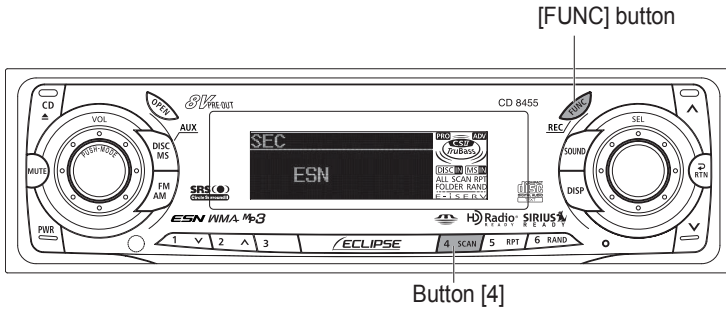

How to read the Electronic Serial Number

- 1** Check that the unit is in standby.
- 2** Press and hold the [FUNC] button, then button [4], and hold both for more than one second.

[ESN] appears on the display, followed by an eight-digit number; this number is your electronic serial number (ESN). You may use this number to identify your Eclipse CD8455 in the event of theft recovery.

Basic operation

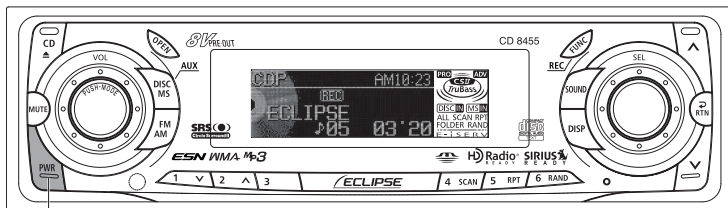

[PWR] button

This section covers basic operating procedures. For additional details, please refer to the sections on specific functions.

IV

Turning the power on and off

When the power is turned on, the state used when the power was turned off such as CD and tuner playback is restored.

When the vehicle has no ACC position on the ignition switch, care is needed when turning off the deck. Follow Step 2 or Step 3 when turning off the power.

1 When power is OFF, press the [PWR] button.

The power will come ON.



ATTENTION

When the deck's power is turned on for the first time or if the battery terminals have been disconnected because of a reason such as vehicle maintenance and the power is then turned back on, the deck will start up in FM1 mode. After this, the broadcast stations will be searched for automatically and stored in buttons [1] to [6].

2 When power is ON, press the [PWR] button for less than two seconds.

The power will go OFF and the deck will be in Standby.

If you press the [PWR] button again for more than one second, the power will go completely off.

3 When power is ON, press the [PWR] button for more than two seconds.

The power will go completely OFF.



ATTENTION

If a car is not equipped with an ACC position (for example, a European car), press the [PWR] button for more than two seconds.

[CD ▲] button [OPEN] button

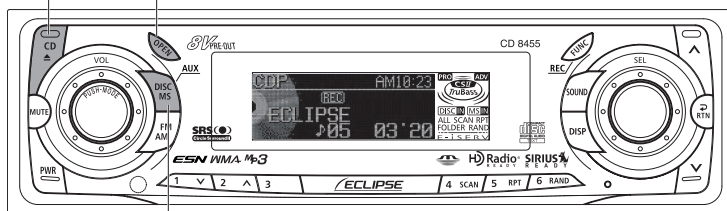

[DISC MS] button

Listening to CD

- 1 Press the [OPEN] or [CD ▲] button.

The front panel opens.

- 2 Insert a CD into the disc slot, label side up.

The CD will immediately start playing.



When a CD is already loaded, press the [DISC MS] button to switch to the CD mode.



Do not press the [OPEN] or [CD ▲] button while CD is being inserted. This could cause an injury and damage to the front panel.

- 3 Press the [OPEN] or [CD ▲] button.

The front panel closes.

[CD ▲] button

[OPEN] button

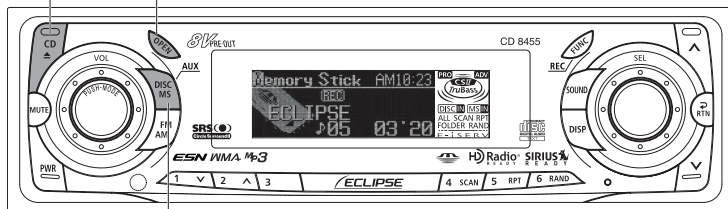

[DISC MS] button

Listening to MG Memory Stick

IV

- 1 Press the [OPEN] or [CD ▲] button.

The front panel opens.

- 2 Insert a MG Memory Stick into the Memory Stick slot.



ATTENTION

- Insert the MG Memory Stick with the mark facing inwards and press MG Memory Stick into place until a clicking sound is heard. Do not press forcefully when the MG Memory Stick makes contact with the internal stopper because it cannot be inserted any further. (The MG Memory Stick should be protruding a few millimeters from the Memory Stick slot.)
- Use a Memory Stick Duo adapter when inserting the Memory Stick Duo. (If the Memory Stick Duo is inserted without the adapter, it will not be ejected from the unit.)
- When the MG Memory Stick is already loaded, press the [DISC] button to switch to the Memory Stick mode.



Caution

Do not press the [OPEN] or [CD ▲] button while the MG Memory Stick is being inserted. This could cause an injury and damage to the front panel.

- 3 Press the [OPEN] or [CD ▲] button.

The front panel closes.

- 4 Press the [DISC MS] button to switch to the Memory Stick mode.

MG Memory Stick will start playing.

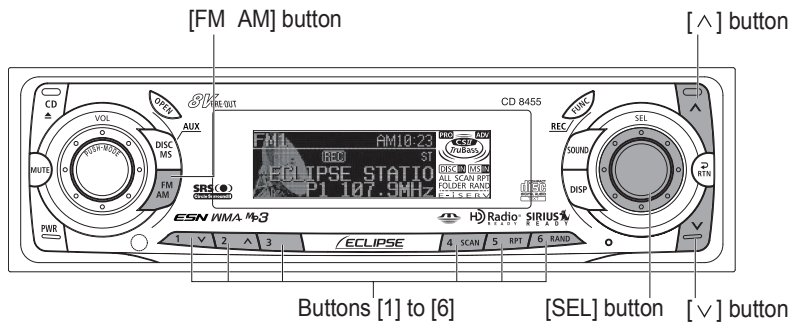

Listening to the tuner

1 Press the [FM AM] button.

This will turn the tuner on.

2 Press the [FM AM] button for less than one second to switch to the desired FM or AM bands.

For example, radio bands will switch from FM1 → FM2 → FM3 → AM with each press of the button. (Depends on memory function setting, described on page 113.)

3 Turn the [SEL] button to the left or right to tune to a station.

Turn to the right: Tunes to higher frequencies.

Turn to the left: Tunes to lower frequencies.

4 Press the [^] or [v] button to start the automatic station search.

[^] button: Starts searching toward higher frequencies.

[v] button: Starts searching toward lower frequencies.



- If stations have been stored in memory, pressing a button from [1] to [6] will directly select a station. (Refer to the section "Manually setting stations into memory" on page 108)
- When an optional HD Radio tuner unit is connected, digital broadcasts have reception priority. (U.S.A. only)

[MUTE] button

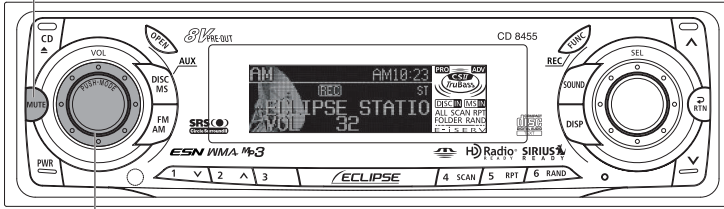

[AUDIO CONTROL] button

Adjusting audio volume

IV

1 Turn the [AUDIO CONTROL] button to the left or right.

Turn to the right: Increases the volume.

Turn to the left: Decreases the volume.



ATTENTION

Press the [MUTE] button for less than one second to cut the volume or restore it instantly.



Warning

Do not adjust the volume or other controls while driving the vehicle. Do so only while parked in a safe location.

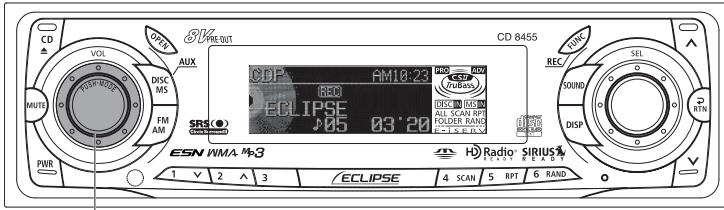

[AUDIO CONTROL] button

Switching audio control modes

Various audio control modes may be fine-tuned using this procedure.

- 1 Press the [AUDIO CONTROL] button for less than one second to select the item to be adjusted.**

Modes will switch in the order shown below each time the button is pressed.

When the audio control is set to the Pro mode:

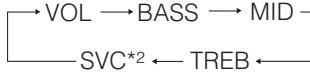

When the audio control is set to the Normal mode:

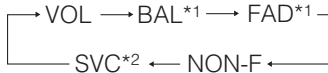

*1: Adjustments cannot be made when the position selector or CS II is ON.

*2: Setting cannot be made in FM mode.

VOL (VOLUME) Mode

Adjusts volume.

Turn the [AUDIO CONTROL] button to the left or right.

Turn to the right: Increases the volume.

Turn to the left: Decreases the volume.

BASS Mode

Adjusts bass level. Bass mode can be adjusted for each source (CDP/CDC, FM and AM and Memory stick player).

Turn the [AUDIO CONTROL] button to the left or right.

Turn to the right: Emphasizes low sounds.

Turn to the left: Softens low sounds.

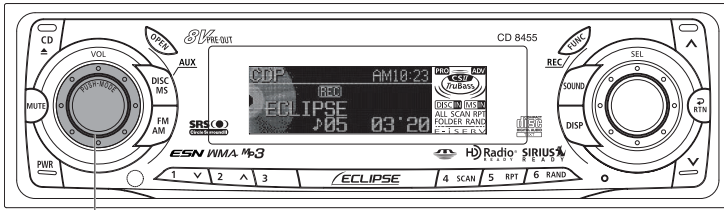

[AUDIO CONTROL] button

MID (MIDDLE) Mode

Adjusts middle level. Mid mode can be adjusted for each source (CDP/CDC, FM and AM and Memory stick player).

Turn the [AUDIO CONTROL] button to the left or right.

Turn to the right: Emphasizes medium sounds.

Turn to the left: Softens medium sounds.

TREB (TREBLE) Mode

Adjusts treble level. Treble mode can be adjusted for each source (CDP/CDC, FM and AM and Memory stick player).

Turn the [AUDIO CONTROL] button to the left or right.

Turn to the right: Emphasizes high sounds.

Turn to the left: Softens high sounds.

BAL (BALANCE) Mode

Adjusts left/right speaker balance.

Turn the [AUDIO CONTROL] button to the left or right.

Turn to the right: Emphasizes right speakers.

Turn to the left: Emphasizes left speakers.

FAD (FADER) Mode

Adjusts front/rear speaker balance.

Turn the [AUDIO CONTROL] button to the left or right.

Turn to the right: Emphasizes front speakers.

Turn to the left: Emphasizes rear speakers.

NON-F (NON-FADER) Mode

Adjusts non-fader level (for connected sub-woofers, etc.).

Turn the [AUDIO CONTROL] button to the left or right.

Turn to the right: Increases level.

Turn to the left: Decreases level.

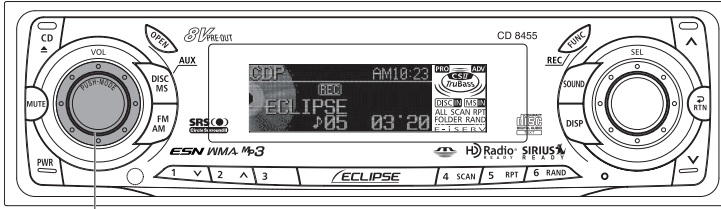

[AUDIO CONTROL] button

SVC (Source Volume Control) Mode

You can set different volume levels for each audio mode. The volume for the initial FM mode (default value: 40) is used as a reference for storing the differences in volume that have been set for each audio mode. When SVC is set, the volume level can change as shown in the example settings in the table below.

Setting examples:

Audio mode	FM	AM	CD	Memory Stick
Default value (Volume level)	Reference (40)	0 (40)	0 (40)	0 (40)
SVC setting (Volume level)	Reference (40)	SVC setting value +15 (55)	SVC setting value -10 (30)	SVC setting value +5 (45)
When volume level in FM mode is adjusted from 40 to 45	45	55 → 60	30 → 35	45 → 50
When volume level in CD mode is adjusted from 35 to 60	45 → 70	60 → 80*	60	50 → 75
When volume level in AM mode is adjusted from 80 to 20	70 → 5	20	60 → 0*	75 → 10
When volume level in Memory Stick mode is adjusted from 10 to 35	5 → 30	20 → 45	0 → 20	35

*: The volume levels can be set to a maximum of 80 and a minimum of 0. If you try to go past the maximum or minimum volume level, the level will not change. For the CD changer, SVC adjusts the volume using the setting value for the CD player.

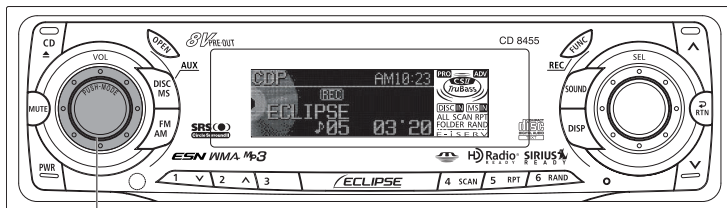

[AUDIO CONTROL] button

Turn the [AUDIO CONTROL] button to the left or right.

Turn to the right: Increases the SVC setting level.

Turn to the left: Decreases the SVC setting level.

The volume difference can be set within a range of -10 to +20.



ATTENTION

If the battery terminals have been disconnected because of a reason such as vehicle maintenance, the SVC settings will return to their default values. If this happens, you will need to make the settings again.

Enabling the loudness control

The loudness control may be turned on to emphasize low and high frequencies at low volume levels.

Loudness compensates for the apparent weakness of low and high frequencies at low volume by boosting the bass and treble levels.

- 1 Press and hold the [AUDIO CONTROL] button until the [LOUD ON] display appears on the screen.



ATTENTION

- To disable the loudness feature, repeat the above procedure to display the [LOUD OFF] indication.
- Loudness control is not available when CSII is ON. In order to enable loudness control, turn OFF CSII. (For details on turning CSII ON/OFF, see page 129.)

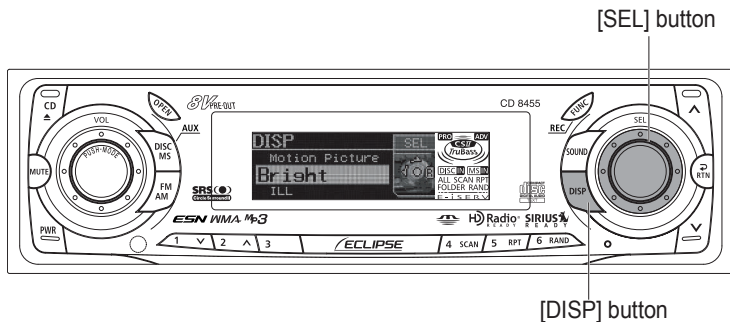

Making changes with Display Adjustment Mode

This mode lets you adjust the display brightness, change the button illumination color and turn the display on and off.

1 Press the [DISP] button for less than one second.

Enters display adjustment mode.



ATTENTION

If you press the [DISP] button during display adjustment mode, the display adjustment mode is canceled and the mode returns to normal music mode.

2 Turn the [SEL] button in either direction to display setting items for selection.

When the button is turned, the setting item changes in the following order and the selected item is highlighted.

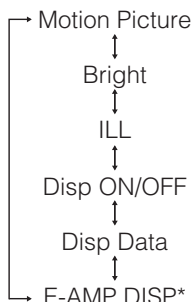

*: Only when the DSP amp is connected.

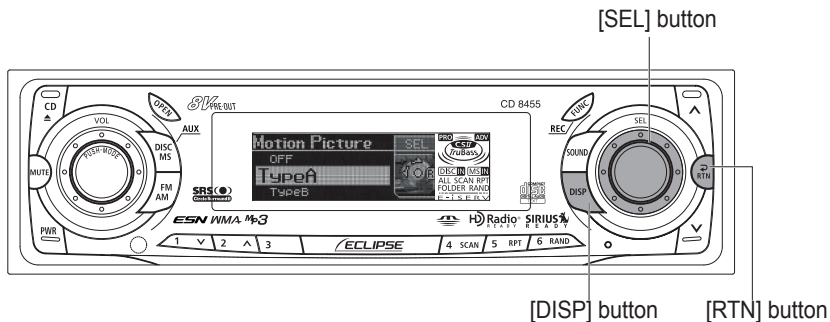

Switching the motion picture

IV

You can select a moving picture screen that is already available in the deck and show it on the display. The deck has three types of motion picture available.

In addition, moving picture screens provided by the ECLIPSE website (E-iSERV) can be downloaded, imported into the deck and displayed. Applications can also be downloaded and your own images can be converted into moving pictures. (For details, see page 55.)

- 1 Turn the [SEL] button to select the Motion Picture.**
The selection item will be highlighted.
- 2 Press the [SEL] button.**
The Motion picture selection mode is activated.
- 3 Turn the [SEL] button to select the Motion Picture Type A, B, C and OFF.**
The selection item will be highlighted.
- 4 Press the [SEL] button.**
The selected settings will take effect.
- 5 Press the [RTN] button.**
At this time, other adjustments can also be made in display adjustment mode.
- 6 Press the [DISP] or [RTN] button to exit display adjustment mode.**

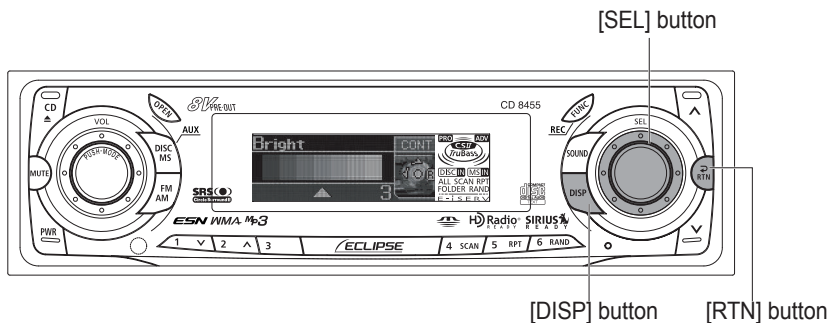

Switching the brightness

Adjust the display brightness to the best level.

- 1 Turn the [SEL] button to select Bright.**
The selected item will be highlighted.
- 2 Press the [SEL] button.**
The mode will change to luminance adjustment mode.
- 3 Turn the [SEL] button to adjust brightness.**
When the button is turned, the brightness level changes in the following order.
(Level) 1↔2↔3↔4↔5
- 4 Press the [SEL] button.**
The selected settings will take effect.
- 5 Press the [RTN] button.**
At this time, other adjustments can also be made in display adjustment mode.
- 6 Press the [DISP] or [RTN] button to exit display adjustment mode.**

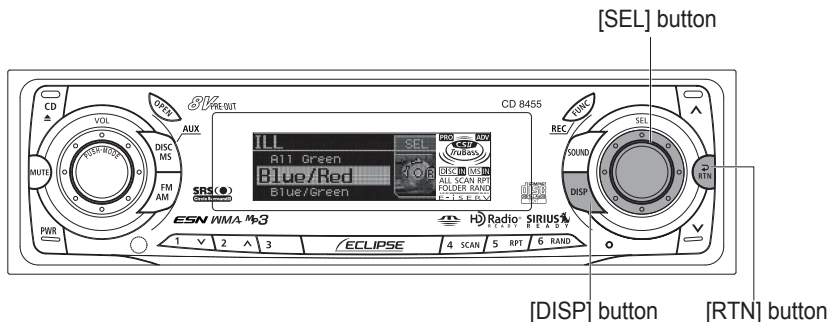

Changing illumination color

You can change the button illumination color in the following way.

- 1 Turn the [SEL] button to select ILL.**
The selected item will be highlighted.
- 2 Press the [SEL] button.**
The screen for changing the illumination color will appear.
- 3 Turn the [SEL] button to adjust the illumination color.**
When the button is turned, the illumination color changes in the following order.

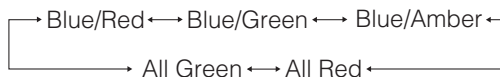

- 4 Press the [SEL] button.**
The selected settings will take effect.
- 5 Press the [RTN] button.**
At this time, other adjustments can also be made in display adjustment mode.
- 6 Press the [DISP] or [RTN] button to exit display adjustment mode.**

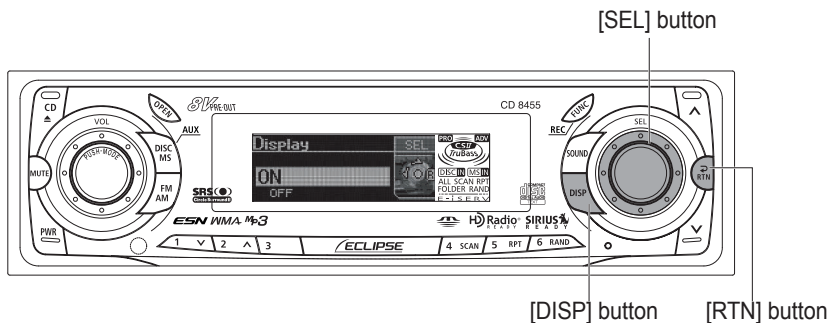

Disabling the display

You can turn the display on and off in the following way.

- 1 Turn the [SEL] button to select Disp ON/OFF.**
The selected item will be highlighted.
- 2 Press the [SEL] button.**
The screen for turning the screen display on and off will appear.
- 3 Turn the [SEL] button to select ON or OFF.**
The selected item will be highlighted.
- 4 Press the [SEL] button.**
The selected settings will take effect.
- 5 Press the [RTN] button.**
At this time, other adjustments can also be made in display adjustment mode.
- 6 Press the [DISP] or [RTN] button to exit display adjustment mode.**



ATTENTION

- When the display is OFF, when one of the buttons is activated, the screen display will come on within 6 seconds.
- When the OFF function is selected, the screen display will turn off. However, it is possible to adjust the display adjustment mode.

Importing DISP screens

Moving picture screens provided by the ECLIPSE website (E-iSERV) can be downloaded and used instead of pre-set moving pictures. To download moving picture screens follow the ECLIPSE website (E-iSERV).

After downloading the data to your PC, copy the data to a Memory Stick or CD-R and import the data into the deck.

(URL: <http://www.e-iserv.jp>)

Applications for creating moving picture screens can be downloaded, allowing you to create your own original moving picture screens. Screens can be created by following the steps shown below:

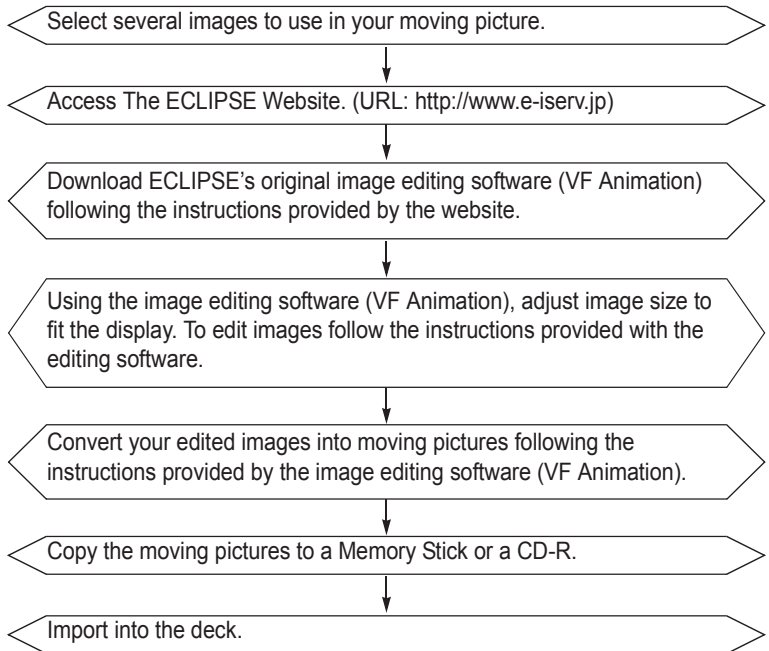

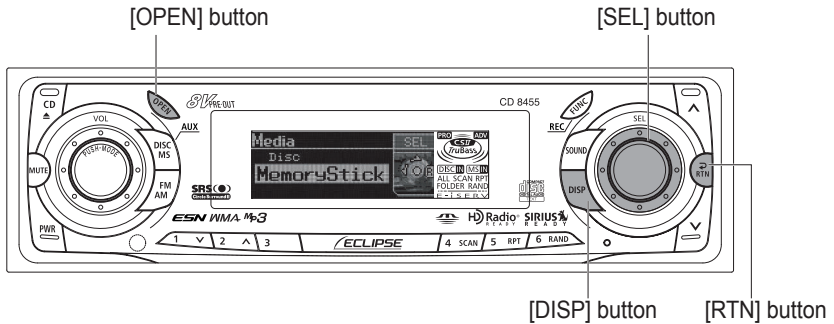

- 1 Turn the [SEL] button to select Disp Data.**
The selected item will be highlighted.
- 2 Press the [SEL] button.**
The Disp Data mode is activated.
- 3 Turn the [SEL] button to select media types.**
- 4 Press the [SEL] button.**
 - When using a CD-R:
The front panel opens automatically and, if a CD has already been loaded into the deck, it will automatically eject.
 - When using a Memory Stick:
If the Memory Stick containing the images is not inserted, the front panel opens automatically.
- 5 Load your selected media.**
- 6 Press the [OPEN] button to close the front panel.**
- 7 Turn the [SEL] button to select files.**
The selected item will be highlighted.
- 8 Press the [SEL] button.**
The moving picture screen will be displayed.
- 9 Turn the [SEL] switch to select from the locations to which you want to import the data: [Type A] – [Type C].**
When the button is turned, the setting item changes in the following order and the selected item is highlighted.

→ Type A ↔ Type B ↔ Type C ←

- 10 Press the [SEL] button.**
[OK?] appears on the display.

11 Press the [SEL] button.

This begins importing the data into the deck. If the data has already been imported, the data will be overwritten. When importing has completed, [Completed] will appear and the front panel opens automatically, and CD-Rs will automatically eject. Press the [OPEN] button to close the panel.



When using a Memory Stick:

- Data downloaded from the ECLIPSE website (E-iSERV) can be saved in folders on the Memory Stick as follows:

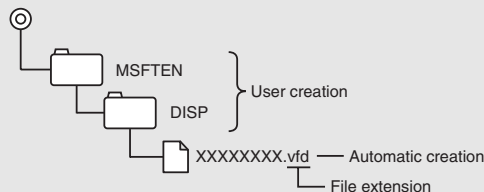

- Files that can be imported into the deck are created automatically when downloaded from the E-iSERV website.
- The file name can be changed using 8 alphanumeric characters (space cannot be used).

When using a CD-R:

- The deck can only import files from CD-R that have been written in root directories.

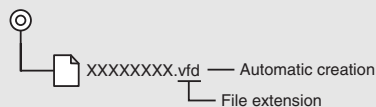

- Disc formats that may be used are as follows:
 - CD-ROM (MODE 1)
 - CD-ROM (MODE2_FORM 1)
 *CD-ROMs written in MODE2_FORM2 cannot be read.
- The file name can be changed using 8 alphanumeric characters (space cannot be used).
- Do not turn ON/OFF the power in this deck or ignition switch while the importing. The importing will be interrupted and the data may be damaged.
- When data is imported from a CD-R, the importing process will take a long time if a lot of data other than the import data has also been saved to the CD-R.

12 Press the [RTN] button.

At this time, other adjustments can also be made in display adjustment mode.

13 Press the [DISP] or [RTN] button to exit display adjustment mode.

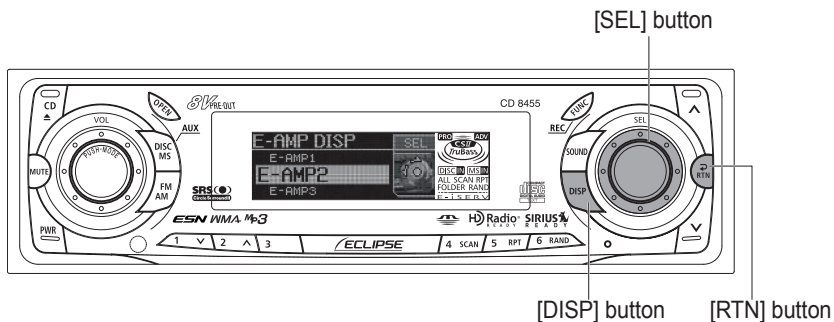

Displaying Amplifier Status (E-AMP DISP)

If a DSP Amp is connected, the status of the DSP amp will be displayed.

- 1 Turn the [SEL] button to select E-AMP DISP.**
The selected item will be highlighted.
- 2 Press the [SEL] button.**
The E-AMP DISP mode is activated.
- 3 Turn the [SEL] button to select which amplifier status you wish to display.**

When the button is turned, the setting item changes in the following order and the selected item is highlighted.

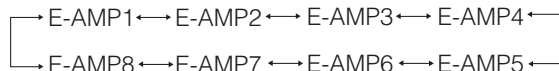

The deck will display all connected amps.

- 4 Press the [SEL] button.**
The status of the selected amp will be displayed.
- 5 Turn the [SEL] button to change display content.**
Each turn of the button allows you to toggle through status categories as follows:

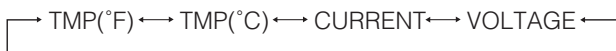

- 6 Press the [RTN] button.**
At this time, other adjustments can also be made in display adjustment mode.
- 7 Press the [DISP] or [RTN] button to exit display adjustment mode.**

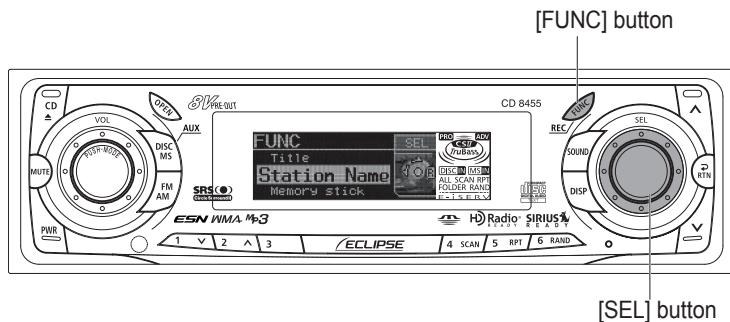

Making changes with Function Mode

IV

A variety of settings can be changed.

1 Press the [FUNC] button for less than one second.

The function mode is activated.



If you press the [FUNC] button during function mode, the adjustment mode is canceled and the mode returns to normal music mode.

2 Turn the [SEL] button in either direction to display setting items for selection.

When the button is turned, the setting item changes in the following order and the selected item is highlighted.

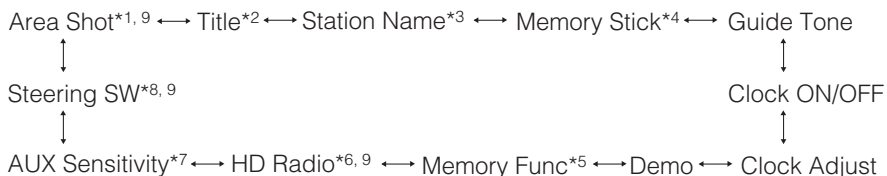

*1: Cannot make settings other than for AREA SHOT operation.
(Refer to page 176 for details on AREA SHOT operation.)

*2: Cannot make settings other than for CD or CD changer operation.
(Refer to page 76 for details on CD operation.)

*3: Cannot make settings other than for tuner operation.
(Refer to page 110 for details on tuner operation.)

*4: Settings cannot be adjusted during recording.

- *5: Refer to page 81 for details on CD operation, and to page 113 for details on tuner operation.
- *6: This setting can only be chosen when HD radio reception is available.
(Refer to page 201 for details on HD Radio operation.)
- *7: Refer to page 211 for details on AUX Sensitivity.
- *8: Refer to page 65 for details on Steering switch.
- *9: U.S.A. only.

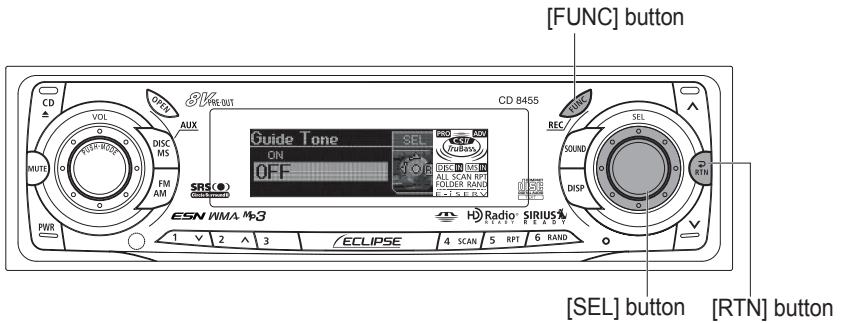

Disabling the guide tone feature (for button operation)

The receiver is set at the factory to emit a beep tone in response to button operation. The guide tone feature may be disabled in the following procedure:

- 1 Turn the [SEL] button to select Guide Tone.**
The selected item will be highlighted.
- 2 Press the [SEL] button.**
The guide tone mode will be switched ON/OFF.
- 3 Turn the [SEL] button to select ON or OFF.**
The selected item will be highlighted.
- 4 Press the [SEL] button.**
The selected settings will take effect.
- 5 Press the [RTN] button.**
At this time, other adjustments can also be made in function mode.
- 6 Press the [FUNC] or [RTN] button to exit function mode.**

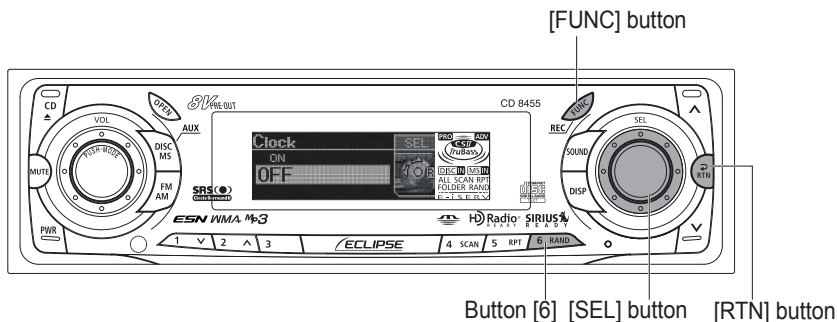

Clock display on/off

Switches the clock display to ON/OFF.

- 1 Turn the [SEL] button to select Clock.**
The selected item will be highlighted.
- 2 Press the [SEL] button.**
The clock display ON/OFF mode is activated.
- 3 Turn the [SEL] button to select ON or OFF.**
The selected item will be highlighted.
- 4 Press the [SEL] button.**
The selected settings will take effect.
- 5 Press the [RTN] button.**
At this time, other adjustments can also be made in function mode.
- 6 Press the [FUNC] or [RTN] button to exit function mode.**



ATTENTION

The clock display can also be turned on and off by pressing the [6] button while the power is turned off.

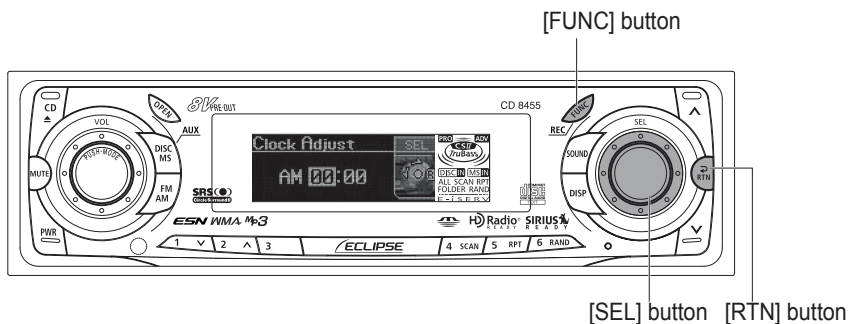

Setting the time

This receiver uses the 12-hour display notation.

- 1 Turn the [SEL] button to select Clock Adjust.**
The selected item will be highlighted.
- 2 Press the [SEL] button.**
The clock adjustment mode is activated.
- 3 Press the [SEL] button to display the item to be selected for adjustment.**
Hours or minutes will be switched each time the button is pressed.
- 4 Turn the [SEL] button.**
Turn to the right: Turns the time forward.
Turn to the left: Turns the time back.
- 5 Press the [RTN] button.**
At this time, other adjustments can also be made in function mode.
- 6 Press the [FUNC] or [RTN] button to exit function mode.**

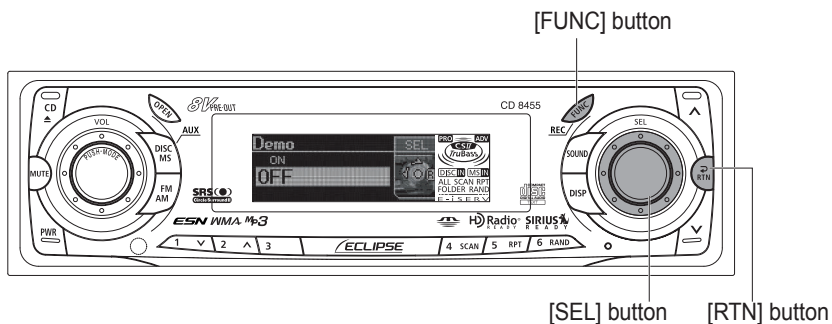

Switching demonstration screen display

You can set the demonstration screen display to appear or not appear when the power is turned on.

When the power turns on, the various demonstration screens such as the audio operation screens and motion picture screens will appear repeatedly in the following order.

Opening screen → FM operation screen → CD operation screen → MP3/WMA operation screen → Memory Stick operation screen → CD Changer operation screen → Sound Adjustment Mode operation screen → Motion Picture A → Motion Picture B → Motion Picture C → Ending screen → Opening screen →

If you press a button while the demonstration screens are being displayed, the demonstration screens will be canceled and the audio operation screen will be displayed. If you do not operate the status display function within 15 seconds, the display will return automatically to the demo screen.

- 1 Turn the [SEL] button to select the Demo.**
The selected item will be highlighted.
- 2 Press the [SEL] button.**
The Demo ON/OFF mode is activated.
- 3 Turn the [SEL] button to select ON or OFF.**
The selected item will be highlighted.
- 4 Press the [SEL] button.**
The selected settings will take effect.
- 5 Press the [RTN] button.**
At this time, other adjustments can also be made in function mode.
- 6 Press the [FUNC] or [RTN] button to exit function mode.**

Setting the steering switch function (U.S.A. only)

The vehicle's factory loaded steering switch becomes inoperable when the CD8455 is installed. The ECLIPSE website (E-iSERV) provides software that enables steering switch operation even with the installation of the deck. Import this software into your CD8455. For details, contact the store from which you purchased your deck. Depending on your vehicle's make and model, material downloaded from the website may not be compatible with your steering switch.

Software for the steering switch can be downloaded and imported into the deck as follows:

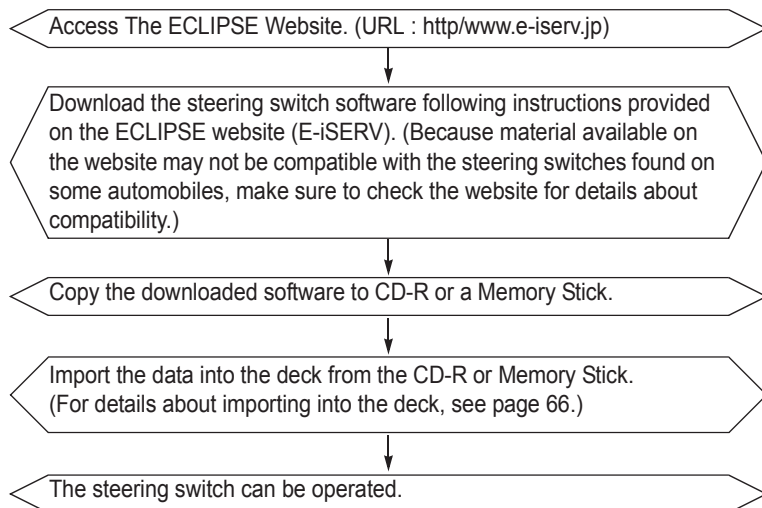

Caution

Consult the store from which you purchased your CD8455 about compatibility and set-up procedures.

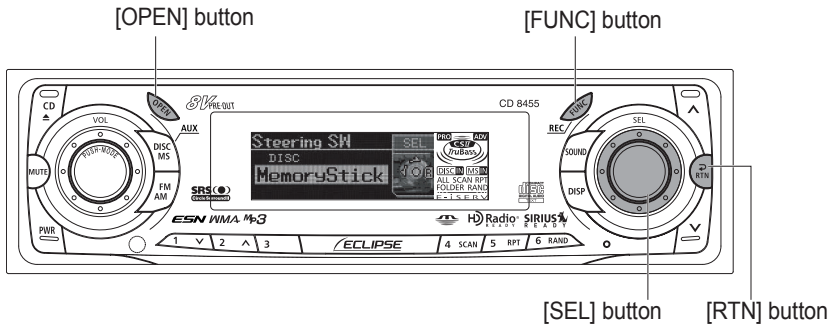

Reading steering switch data

The steering switch data that has been downloaded from E-iSERV (website) to a Memory Stick or CD-R can be loaded into the deck and saved there.

1 Press the [FUNC] button for less than one second.

The function mode is activated.

2 Turn the [SEL] button to select Steering SW.

3 Press the [SEL] button.

4 Select media by turning the [SEL] button.

5 Press the [SEL] button.

“INSERT DISC” or “INSERT MS” will be displayed and the panel will open automatically.

6 Insert the Memory Stick or CD-R to be used for saving the steering switch data.

7 Press the [OPEN] button to close the front panel.

8 Turn the [SEL] button to select the file to be saved.

The selected file name is highlighted.

9 Press the [SEL] button.

The CD-R or Memory Stick data is read. While it is reading, [READING] is displayed.

If the data can be read successfully, [Completed] will appear on the display. When using CD-R data, the CD-R will automatically eject when reading is complete.



Caution

Do not turn off power or ignition switch during reading process. This will corrupt the data.



When using a Memory Stick:

Data downloaded from the ECLIPSE website (E-iSERV) can be saved in folders on the Memory Stick as follows:

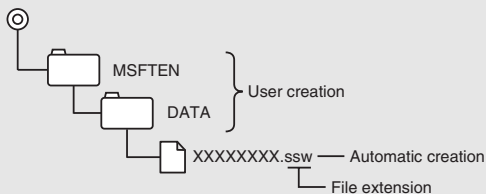

- Files that can be imported into the deck are created automatically when downloaded from the E-iSERV website.
- The file name can be changed using 8 alphanumeric characters (space cannot be used).

When using a CD-R:

- The deck can only import files from CD-R that have been written to root directories.

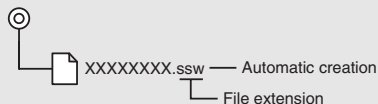

- Disc formats that may be used are as follows:
 - CD-ROM (MODE 1)
 - CD-ROM (MODE2_FORM 1)
 *CD-ROMs written in MODE2_FORM2 cannot be read.
- The file name can be changed using 8 alphanumeric characters (space cannot be used).

8 Press the [RTN] button.

At this time, other adjustments can also be made in function mode.

9 Press the [FUNC] or [RTN] button to exit function mode.

During Step **8**, the function mode can also be cancelled by pressing the [FUNC] button.

Compatibility with various switches

The compatibility of the deck's various modes and the steering switches installed on your vehicle are as follows:

Switch Name ^{*1}	Button operation	Mode		
		Tuner	Disc mode	AUX
SEEK+	Short tap	TUNE UP	TRACK UP	–
	Hold	SEEK UP ^{*2}	FAST UP	–
SEEK-	Short tap	TUNE DOWN	TRACK DOWN	–
	Hold	SEEK DOWN ^{*2}	FAST DOWN	–
VOL+	Short tap	Volume UP	Volume UP	Volume UP
	Hold	Gradually increases volume	Gradually increases volume	Gradually increases volume
VOL-	Short tap	Volume DOWN	Volume DOWN	Volume DOWN
	Hold	Gradually decreases volume	Gradually decreases volume	Gradually decreases volume
MODE	–	Change to the disc mode	Change to the AUX mode	Change to the tuner mode

Switch Name ^{*1}	Button operation	Mode	
		Others	Power OFF
SEEK+	–	–	–
SEEK-	–	–	–
VOL+	Short tap	Volume UP	–
	Hold	Gradually increases volume	–
VOL-	Short tap	Volume DOWN	–
	Hold	Gradually decreases volume	–
MODE	–	Change to the various audio modes	Power ON in the tuner mode

^{*1}: Switch names change depending on vehicle make and model.

^{*2}: If a SIRIUS satellite radio tuner (purchased separately) is connected, categories can be switched when in the satellite mode.

Others

Operation assist function

In display adjustment mode, function mode and sound adjustment mode, the screen displays help to guide you in carrying out operations.

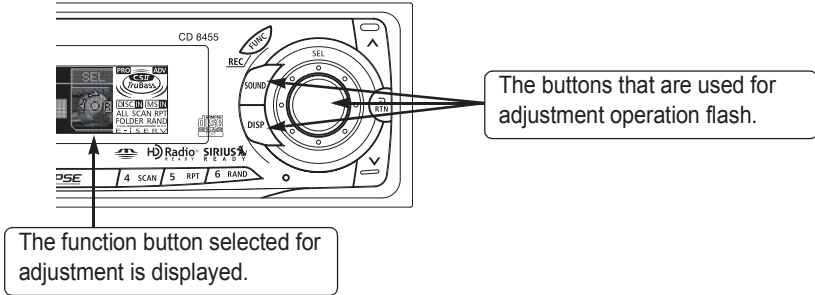

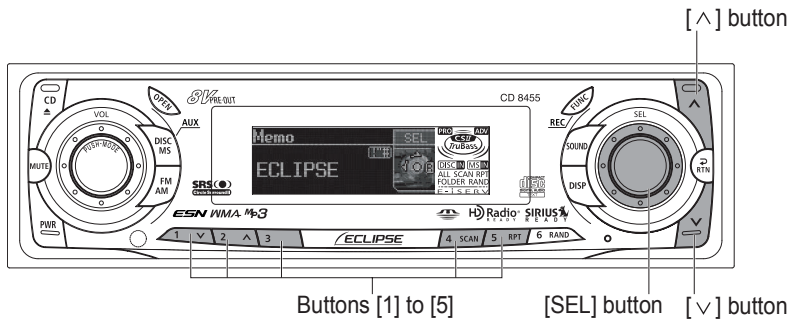

Displaying a memo

If memos have been set, a memo recorded corresponding to a number button [1] to [5] appears on the screen when the number button is pressed briefly while the power of the main unit is turned off.

Setting a memo

- 1 Press and hold any number button for more than two seconds while in the Standby mode.**

The state shifts to the MEMO setting mode.

- 2 Press the [^] button to select the character type.**

Pressing the button will switch types from [ABC] (alphabet characters) to [123] (numeric characters) and then [!&?] (symbols).

- 3 Press either [SEL] or [v] button to select the position in which to enter the character.**

The character will be inserted where the cursor is flashing:

[SEL] button: Moves the cursor to the right.

[v] button: Advances the cursor to the left. Pressing and holding the [v] button moves the cursor to the left.

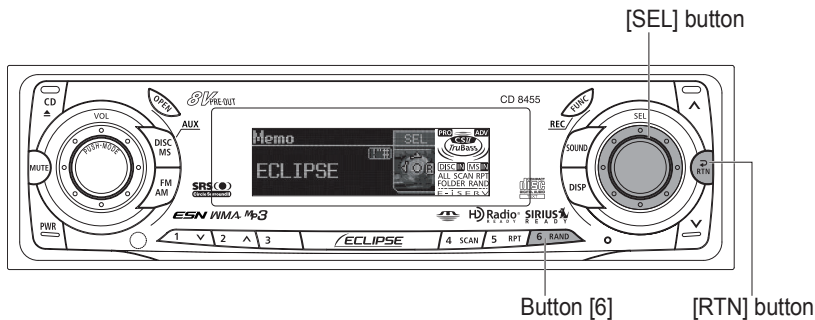

4 Turn the [SEL] button to the left or right to select characters.

Turn to the right: Advances the character forward in its type.

Turn to the left: Moves the character backward in its type.

[Upper-case alphabet characters] Initial value [A] [Right direction]

→A→B→C→…→X→Y→Z

[Numeric characters] Initial value [1] [Right direction]

→1→2→3→…→8→9→0

[Symbol] Initial value [!] [Right direction]

→!→"→#→\$→%→&→'→(→)→*→+→,→-→.→/→:→;→<→=→>→?→@→'→_

5 Press the [SEL] button to select characters.



ATTENTION

- To change the type of character to be entered, repeat steps 2 and 3.
- A maximum of 10 characters may be entered per memo.
- A maximum of 5 memos may be stored.

6 Press the [RTN] button.

Memo settings are now completed.

Deleting a memo

1 Press the number button corresponding to the memo to be deleted for more than two seconds while the power is turned off.

2 Press the [6] button for more than two seconds.

The memo will be deleted.

How to operate the CD player

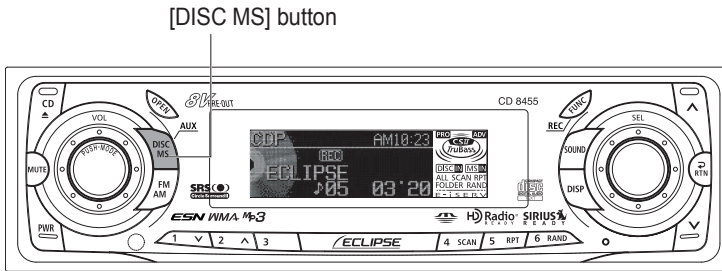

First press the [DISC MS] button for less than one second to switch to the disc mode. It is assumed here that a CD has already been loaded into the unit.

Listening to CDs

- 1 Press the [DISC MS] button for less than one second to switch to the CD player mode.

This starts CD play.

Disc mode will switch from CD player → Memory Stick player in order each time the button is pressed.

If an external CD changer is connected, each additional press of the [DISC] button will switch modes from CD changer 1 → CD changer 2 → Memory Stick player → CD player.

A changer or player with no discs loaded will be skipped.



Caution

- Playback may be intermittent when there is a scratch on a CD or when the recorded side is dirty.
- Only two external CD changers may be connected.

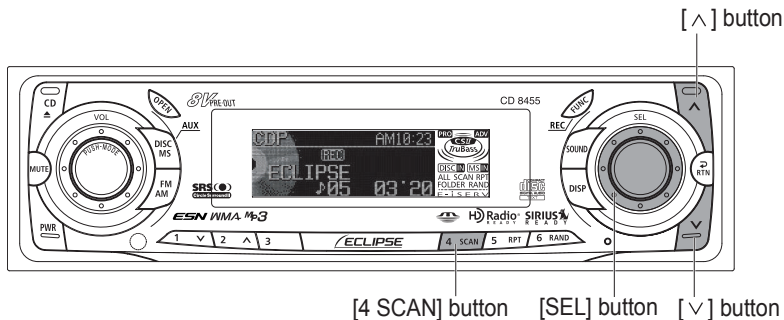

Advancing to the next track or returning to the beginning of the track being played

1 Turn the [SEL] button to the left or right.

Turn to the right: Advances to the next track.

Turn to the left: Returns to the beginning of the track being played.
(Repeat turning for previous tracks.)

Fast Forward/Rewind

Fast forward or rewind the song currently being played.

1 Press and hold the [^] or [v] button.

[^] button: Fast forward.

[v] button: Rewind.

Playing the beginning of tracks (SCAN)

1 Press the [4 SCAN] button.

Pressing the button causes the player to move up to the next track and play it for 10 seconds, then move up to the next track and play it for 10 seconds, and so on until the button is pressed again.



- To continue playing a desired track, press the button again to stop scanning.
- After the entire disc is scanned once, ordinary playback starts from the point where scanning started.

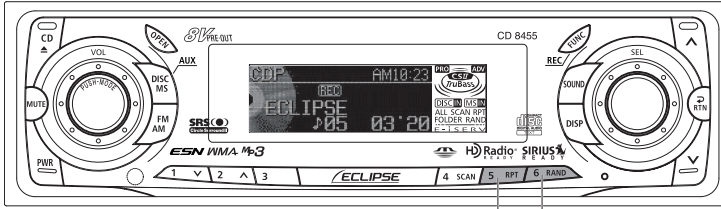

[5 RPT] button [6 RAND] button

Repeating the same track (REPEAT)

- 1 Press the [5 RPT] button to repeat the track being played.

To cancel, press the [5 RPT] button again.

Playing tracks in random order (RANDOM)

- 1 Press the [6 RAND] button to play the tracks in random order.

To cancel, press the [6 RAND] button again.



ATTENTION

- During random playback, press the [5 RPT] button to repeat the track being played. To cancel repeat play (go back to random play), press the [5 RPT] button again.
During playback of a particular track: The track being played is played repeatedly.
While searching: The following track is played repeatedly.
- Occasionally the same track happens to be played (selected) two or more times in a row; this is normal operation and is not a sign of a problem.
- When any of the functions - "Playing the beginning of tracks," "Repeating the same track" and "Playing tracks in random order" - is selected, a message such as [SCAN], [REPEAT] or [RANDOM] appears on the display to verify the current function.

[CD▲] button [OPEN] button

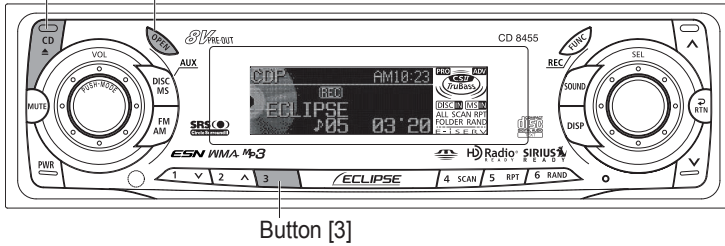

Switching a CD to pause / play

- 1 Press button [3].

It pauses playing a CD.
To cancel, press button [3] again.

V

Ejecting the disc

- 1 Press the [CD▲] button.
The front panel opens and the disc is ejected.
- 2 Remove the disc and press the [CD▲] or [OPEN] button.
The front panel closes. If left alone for 15 seconds after the disc ejection, the front panel closes after the BEEP sound.



Caution

- Do not drive with the front panel open. The panel may cause unexpected personal injury during a panic stop, or the like.
- Do not attempt to close the front panel by hand. Doing so may damage the panel.

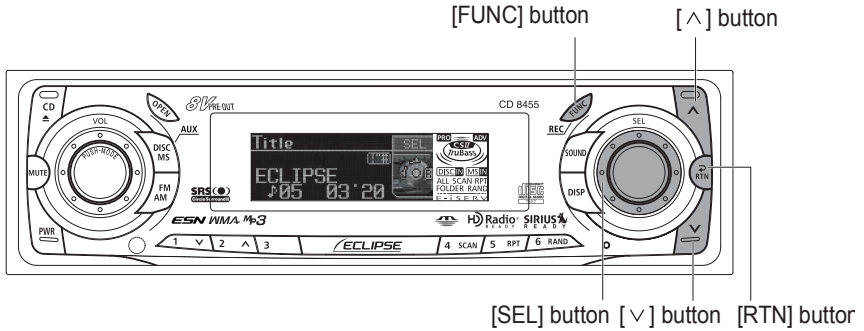

Creating a title for a CD

A CD title may be created, attached and displayed for your discs. If external CD changers are connected, a title for a CD will be created in the same way. It is assumed here that the CD to be titled is playing.



No CD text disc can be set.

- 1 Press the [FUNC] button for less than one second while in the disc mode.**

The function mode is activated.

- 2 Turn the [SEL] button to select Title.**

The selected item will be highlighted.

- 3 Press the [SEL] button.**

The disc title setting mode is activated.

- 4 Press the [^] button to select the character type.**

Pressing the button will switch types from [ABC] (Upper-case alphabet characters) to, [123] (numeric characters) and then [!&?] (symbols).

- 5 Press either [SEL] or [v] button to select the position in which to enter the character.**

The character will be inserted where the cursor is flashing:

[SEL] button: Moves the cursor to the right.

[v] button: Advances the cursor to the left. Pressing and holding the [v] button moves the cursor to the left.

6 Turn the [SEL] button to the left or right to select characters.

Turn to the right: Advances the character forward in its type.

Turn to the left: Moves the character backward in its type.

[Upper-case alphabet characters] Initial value [A] [Right direction]

→A→B→C→...→X→Y→Z

[Numeric characters] Initial value [1] [Right direction]

→1→2→3→...→8→9→0

[Symbol] Initial value [!] [Right direction]

→!→*→#→\$→%→&→'→(→)→*→+→,→-→.→/→:→;→<→=→>→?→@→'→_

7 Press the [SEL] button to select characters.



ATTENTION

- To change the type of character to be entered, repeat steps 3 and 4.
- A maximum of 14 characters may be entered per title.
- 30 to 100 titles (changeable) can be stored (Use store).
- If the number of discs that can be memorized is exceeded, the information about the disc whose playing time is oldest is deleted.

8 Press the [RTN] button.

At this time, other adjustments can also be made in function mode.

9 Press the [FUNC] or [RTN] button to exit function mode.

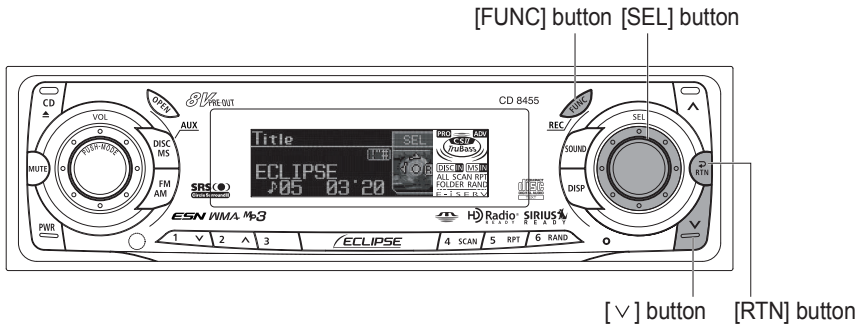

Changing a previously set title

If external CD changers are connected, a previously set title for a CD will be changed in the same way. It is assumed here that the disc mode is selected.

- 1 Press the [FUNC] button for less than one second while in the disc mode.**

The function mode is activated.

- 2 Turn the [SEL] button to select Title.**

The selected item will be highlighted.

- 3 Press the [SEL] button.**

The disc title setting mode is activated.

- 4 Press either [SEL] or [V] button to move the cursor to the position in the title for inserting or changing characters.**

[SEL] button: Moves the cursor to the right.

[V] button: Advances the cursor to the left.

5 Turn the [SEL] button to the left or right to select characters.

Turn to the right: Advances the character forward in its type.

Turn to the left: Moves the character backward in its type.

6 Press the [SEL] button.

The selected settings will take effect.



To leave a space blank, follow these steps.

1. Select and flash the space to be blank.
2. Turn the [SEL] button to make a blank space flashing.
3. Press the [SEL] button to move.

7 Press the [RTN] button.

At this time, other adjustments can also be made in function mode.

8 Press the [FUNC] or [RTN] button to exit function mode.

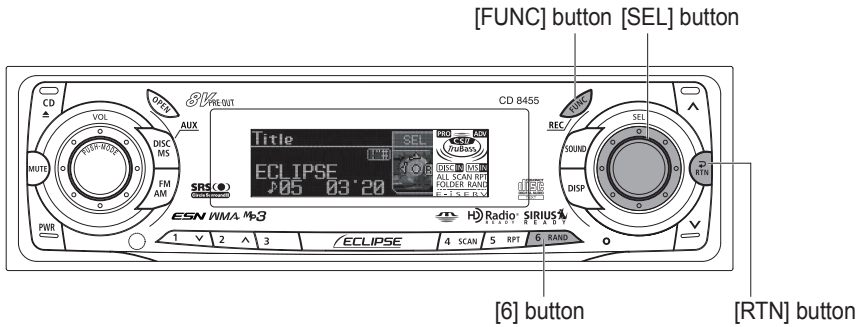

Deleting a previously created title

If external CD changers are connected, a previously created title for a CD will be deleted in the same way. It is assumed here that the disc mode is selected.

- 1 Press the [FUNC] button for less than one second while in the disc mode.**

The function mode is activated.

- 2 Turn the [SEL] button to select Title.**

The selected item will be highlighted.

- 3 Press the [SEL] button.**

The CD title being played at this point will be deleted.

- 4 Hold the [6] button down for more than two seconds.**

The title has now been deleted.

- 5 Press the [RTN] button.**

At this time, other adjustments can also be made in function mode.

- 6 Press the [FUNC] or [RTN] button to exit function mode.**

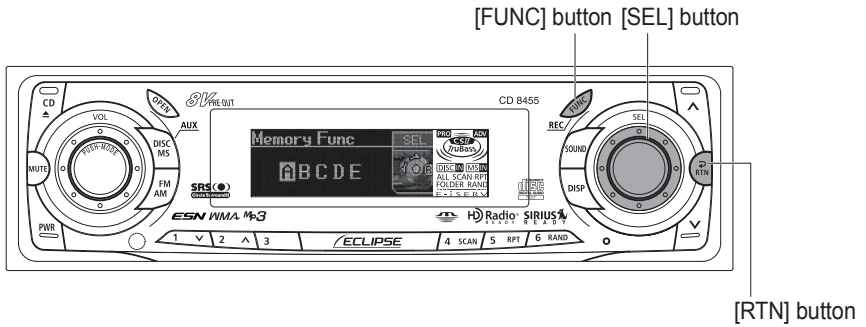

Changing the number of CD titles

The number of CD titles that can be set can be changed by changing the memory allocation. The number of CD titles is fixed for each pattern and the number of tuner bands that can be recorded is also changed at the same time.

- 1 Press the [FUNC] button for less than one second while in the disc mode.**

The function mode is activated.

- 2 Turn the [SEL] button to select Memory Func.**

The selected item will be highlighted.

- 3 Press the [SEL] button.**

The mode will change to memory allocation address selection mode.

4 Turn the [SEL] button to select an address from A to E.

The patterns switches between the following. The characters for the selected item are highlighted and the memory allocation address changes.

MEMORY A (standard)	AM/FM: 1/3, CD title memory: 30 titles
MEMORY B	AM/FM: 2/5, CD title memory: 40 titles
MEMORY C	AM/FM: 1/3, CD title memory: 60 titles
MEMORY D	AM/FM: 2/5, CD title memory: 80 titles
MEMORY E	AM/FM: 3/8, CD title memory: 100 titles



If an optional HD radio tuner unit is connected, the number of AM/FM bands is 1/3.

5 Press the [SEL] button.

The selected settings will take effect.

6 Press the [RTN] button.

At this time, other adjustments can also be made in function mode.

7 Press the [FUNC] or [RTN] button to exit function mode.

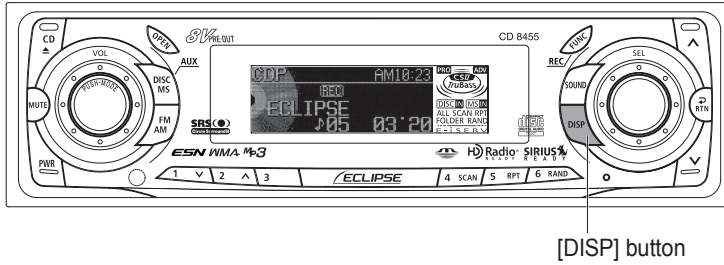

Displaying CD text

Only the built-in CD player supports CD TEXT. It can not be displayed with the optional CD changer. If the CD came with a logo shown below, it is recorded with a disc title and track titles. These information will be displayed during playback.



1 Press the [DISP] button for more than one second.

Pressing the [DISP] button while text is displayed scrolls the display in the order DISC title → TRACK title, and then the display stops with the TRACK title.

CD TEXT recorded with characters other than alphanumeric and symbols cannot be displayed.

How to operate the MP3/WMA player

About MP3/WMA



The making of MP3/WMA files by recording from sources such as broadcasts, records, recordings, videos and live performances without permission from the copyright holder for uses other than personal enjoyment is prohibited.

What is MP3/WMA?

MP3 (MPEG Audio Layer III) is a standard format for audio compression technology. By using MP3 a file can be compressed to one-tenth the size of the original.

WMA (Windows Media™ Audio) is format for audio compression technology. WMA files can be compressed to a size smaller than MP3 files.

This deck has limitations on MP3/WMA file standards and recorded media and formats that can be used.

Playable MP3 file standards

- Supported standards: MPEG-1 Audio Layer III
- Supported sampling frequencies: 44.1, 48 (kHz)
- Supported bit rate: 64, 80, 96, 112, 128, 160, 192, 224, 256, 288, 320 (kbps)
 - * Supports VBR. (64~320kbps)
 - * Does not support free format.
- Supported channel modes: stereo

Playable WMA file standards

- Supported standards: WMA Ver. 7
WMA Ver. 8
WMA Ver. 9
- Supported sampling frequencies: 32, 44.1, 48 (kHz)
- Supported bit rate: 48, 64, 80, 96, 128, 160, 192, 256, 320 (kbps)
 - * Supports VBR (48~192 kbps).
 - * Does not support lossless compression.
 - * Does not support WMA files recorded at a frequency of 48kHz with a bit rate of 48kbps.

ID3/WMA tags

MP3/WMA files have an "ID3/WMA Tag" that allows input of information so that data such as song title and artist can be saved. This deck supports ID3v. 1.0, 1.1 and WMA tags.

Media

Media capable of playing MP3/WMA includes CD-R and CD-RW discs. Compared to CD-ROM media commonly used for music discs, CD-R and CD-RW discs are fragile in high temperature/high humidity environments and one section of the CD-R and CD-RW may become incapable of playback. Fingerprints or scratches on the disc may prevent playback or cause skipping during playback. Sections of a CD-R and CD-RW may deteriorate if left inside a vehicle for long periods of time. It is also recommended that CD-R and CD-RW discs be kept in a light-blocking case because the discs are vulnerable to ultra-violet light.

Format of discs

The format of discs to be used must be ISO9660 Level 1 or Level 2. Control items for this standard are as follows:

- Maximum directory layers: 8 layers
- Maximum characters for folder names/file names: 32 (including ".", and 3 letter file extension)
- Allowable characters for folder names/file names: A~Z, 0~9, _ (underscore)
- Number of files/folders possible on a single disc: 999

[Configuration example for CD supporting MP3/WMA]

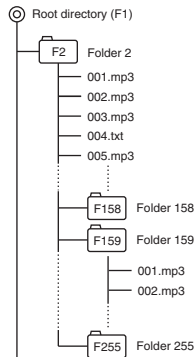

Number of files/folders possible on a single disc is 999.
Files aside from MP3/WMA files (Example: 004.txt) also count as single files.

- Total number of folders possible on a single disc: 255
 - Maximum folders this deck can recognize: 256*
- *: A root directory is counted as one folder.

File names

Only files with the MP3/WMA file extension ".mp3", ".wma" can be recognized as MP3/WMA and played. Be sure to save MP3 files with the ".mp3" file extension. Be sure to WMA files with the ".wma" file extension. The "MP" or "WMA" letters of the file extension will be recognized whether entered as uppercase letters or lowercase letters.



Caution

If the ".mp3", ".wma" file extension is attached to a file other than an MP3/WMA file, that file will be mistakenly recognized by the deck as an MP3/WMA file and played, resulting in loud noise output that can damage the speakers. Be sure to avoid attaching the ".mp3", ".wma" file extension to files that are not MP3/WMA files.

Multi-sessions

Multi-sessions are supported, and playing of CD-R and CD-RW discs with annotated MP3/WMA files is possible. However, when "Track at once" has been written, close the session or process the warning message. Standardize the format of each session without changing the format.

VI

Playing MP3/WMA

When a disc with recorded MP3/WMA files is inserted, the deck first checks all the files on the disc. No sound is output while the deck is checking the files on the disc. It is recommended that the disc be recorded without files other than MP3/WMA files and without unnecessary folders in order to speed up the checking of disc files by the deck.

MP3/WMA playing time display

It is possible that playing time will not be correct, depending on the writing condition of the MP3/WMA file.

* It is possible that playing time will not be correct when VBR Fast Up/Down is operated.

Display order of MP3/WMA file/folder names

Names of MP3/WMA folders and files within the same level are displayed in the following order.

1. MP3/WMA folders displayed first, by ascending order of numbers, letters.
2. Files displayed next, by ascending order of numbers, letters.

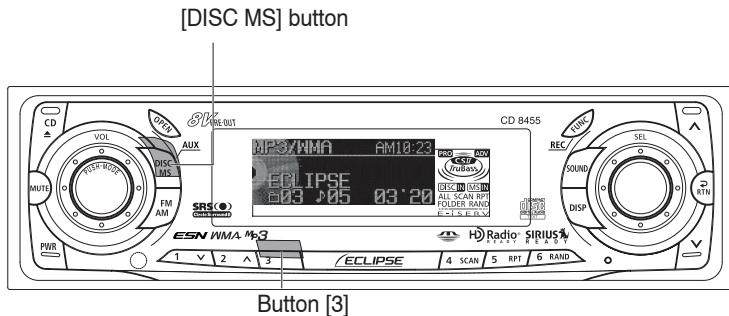

Listening to MP3/WMA file

- 1 Press the [DISC MS] button for less than one second to switch to the CD player mode.

This starts MP3/WMA file play.

Disc mode from CD player → Memory Stick player in order each time the button is pressed.

If an external CD changer is connected, each additional press of the [DISC MS] button will switch modes from CD changer 1 → CD changer 2 → Memory Stick player → CD player.

A changer or player with no discs loaded will be skipped.



Caution

- Playback may be intermittent when there is a scratch on a CD or when the recorded side is dirty.
- Only two external CD changers may be connected.

● Note ●

- When music data recorded in the normal way (CD-DA) is present on the same disc with MP3/WMA music files, the normally recorded music data will be played. To listen to the MP3/WMA music files, press button [3] for more than one second.
- When a non-MP3/WMA file is played, "NO SUPPORT" will appear.
- The optional CD changer cannot be used to play MP3/WMA files.
- WMA files protected by license control are skipped. Playback continues after the skipped file. In the event that all files are protected by license control the CD-R will not playback and "PROTECT" will be displayed.

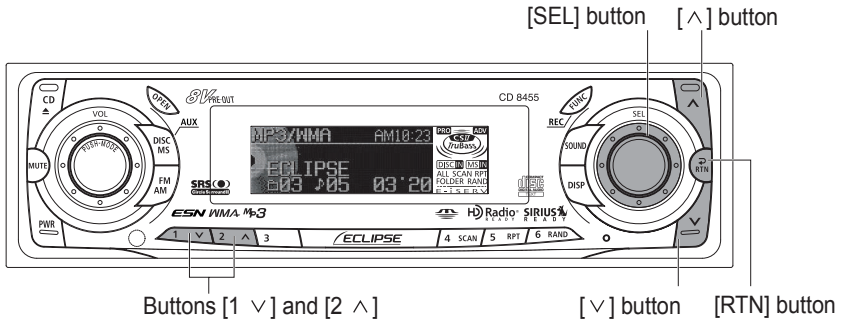

Advancing to the next track (file) or returning to the beginning of the track (file) being played

- 1 Turn the [SEL] button to the left or right.

Turn to the right: Advances to the next track (file).

Turn to the left: Returns to the beginning of the track (file) being played.

Repeat turning for previous tracks (files).

VI

Skipping to the next or previous folder

- 1 Press button [1 v] or [2 ^].

Button [1 v]: Selects the next lower folder.

Button [2 ^]: Selects the next folder.

Fast Forward/Rewind

Fast forward or rewind the song currently being played.

- 1 Press and hold the [^] or [v] button.

[^] button: Fast forward.

[v] button: Rewind.

Return to the root directory of the CD

In the root directory, when a file cannot replay, the system will return to the first file that can perform a replay. (In the configuration example, the file is returning to 001.mp3. See page 86.)

- 1 Press the [RTN] button.

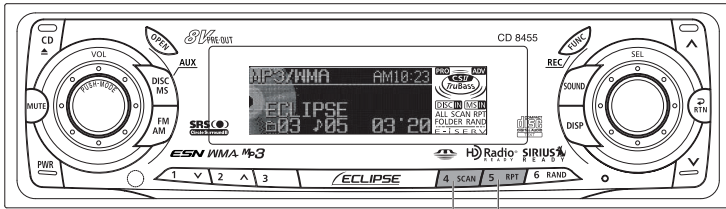

[4 SCAN] button [5 RPT] button

Playing the beginning of files (SCAN)

1 Press the [4 SCAN] button.

Press the button briefly to play just the first 10 seconds of each song for all the files in the same layer of the folder being played. Pressing the button until [FOLDER SCAN] is displayed will play just the first 10 seconds of the first song in each folder.



ATTENTION

- To continue playing a desired file, press the button again to stop scanning.
- After the entire disc is scanned once, ordinary playback starts from the point where scanning started.

Repeating the same file (REPEAT)

1 Press the [5 RPT] button.

Press the button briefly to repeat the file being played. Pressing the button until [FOLDER REPEAT] is displayed will repeat all the files in the same layer as the folder being played. To cancel, press the [5 RPT] button again.

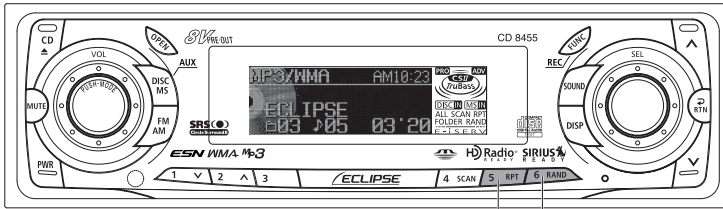

[5 RPT] button [6 RAND] button

Playing files in random order (RANDOM)

1 Press the [6 RAND] button.

Press the button briefly to randomly play the files in the same layer as the folder being played.

Pressing the button until [ALL RANDOM] is displayed will randomly play the files in all the folders.

To cancel, press the [6 RAND] button again.



ATTENTION

- During random playback, press the [5 RPT] button to repeat the file being played. To cancel repeat play (go back to random play), press the [5 RPT] button again.
During playback of a particular file: The file being played is played repeatedly.
While searching: The following file is played repeatedly.
- Occasionally the same file happens to be played (selected) two or more times in a row; this is normal operation and is not a sign of a problem.

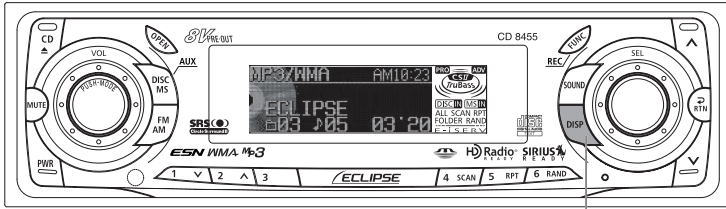

[DISP] button

Displaying title

1 Press the [DISP] button for more than one second.

Each time the button is pressed, the following will be displayed in order.

Folder Name/File Name* → Tag

*: The display area shows a maximum of 14 characters and then scrolls to display the remaining characters.

After the folder name is displayed, the file name will be displayed by scrolling. After the file name is scrolled, the display will be fixed.



Folder name/file name or tag recorded with characters other than alphanumeric and symbols cannot be displayed.

How to operate the Memory Stick player

Music data recorded on "MG Memory Stick" with ATRAC3 (an audio compression technology) can be played on this deck. Recording from music CD to the MG Memory Stick is also possible. The following explanation for the operation is made assuming that the MG Memory Stick has already been inserted.

First press the [DISC MS] button for less than one second to switch to the disc mode. It is assumed here that a MG Memory Stick has already been loaded into the deck.



- Artist name and music title (track titles) can be displayed when they are recorded on the MG Memory Stick. A maximum of 10 characters (1 byte alphabets, numeric or symbols) can be displayed.
- Music data recorded with MP3/WMA and ATRAC3 Plus cannot be played.

[DISC MS] button

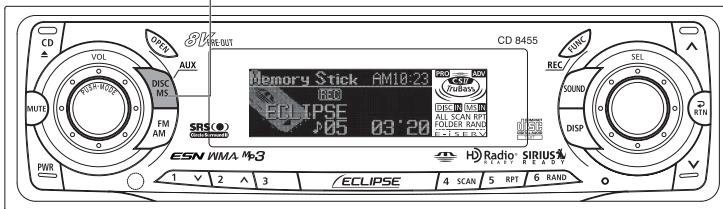

VII

Listening to MG Memory Stick

- 1 Press the [DISC MS] button for less than one second to switch to the Memory Stick player mode.**

Disc mode will switch from CD player → Memory Stick player in order each time the button is pressed.

If an external CD changer is connected, each additional press of the [MS] button will switch modes from CD changer 1 → CD changer 2 → Memory Stick player → CD player.

A changer or player with no discs loaded will be skipped.

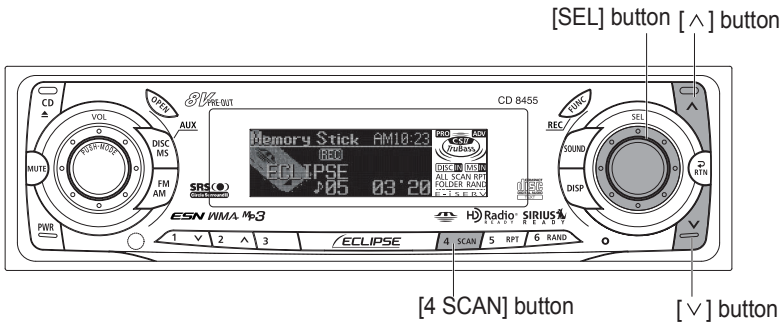

Advancing to the next track or returning to the beginning of the track being played

1 Turn the [SEL] button to the left or right.

Turn to the right: Advances to the next track.

Turn to the left: Returns to the beginning of the track being played.
(Repeat turning for previous tracks.)

Fast Forward/Rewind

Fast forward or rewind the song currently being played.

1 Press and hold the [^] or [v] button.

[^] button: Fast forward.

[v] button: Rewind.

Playing the beginning of tracks (SCAN)

1 Press the [4 SCAN] button.

Pressing the button causes the player to move up to the next track and play it for 10 seconds, then move up to the next track and play it for 10 seconds, and so on until the button is pressed again.



- To continue playing a desired track, press the button again to stop scanning.
- After the entire disc is scanned once, ordinary playback starts from the point where scanning started.

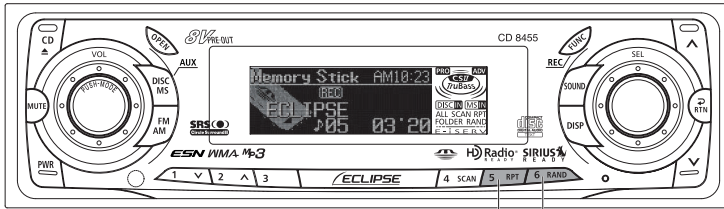

[5 RPT] button [6 RAND] button

Repeating the same track (REPEAT)

- 1 Press the [5 RPT] button to repeat the track being played.

To cancel, press the [5 RPT] button again.

Playing tracks in random order (RANDOM)

VII

- 1 Press the [6 RAND] button to play the tracks in random order.

To cancel, press the [6 RAND] button again.



ATTENTION

- During random playback, press the [5 RPT] button to repeat the track being played. To cancel repeat play (go back to random play), press the [5 RPT] button again.
During playback of a particular track: The track being played is played repeatedly.
While searching: The following track is played repeatedly.
- Occasionally the same track happens to be played (selected) two or more times in a row; this is normal operation and is not a sign of a problem.
- When any of the functions - "Playing the beginning of tracks", "Repeating the same track" and "Playing tracks in random order"- is selected, a message such as [SCAN], [REPEAT] or [RANDOM] appears on the display to verify the current function.

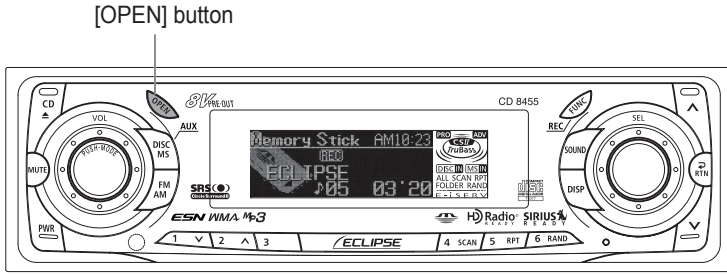

Ejecting the Memory Stick

- 1 Press the [OPEN] button.**
The front panel opens.
- 2 Eject the Memory Stick.**
Lightly press the Memory Stick once.



Memory Stick will not eject by itself. Lightly press the Memory Stick to eject.



- Do not drive with the front panel open. The panel may cause unexpected personal injury during a panic stop, or the like.
- Do not attempt to close the front panel by hand. Doing so may damage the panel.
- Do not eject the Memory Stick while the Memory Stick access indicator is illuminated.

- 3 Press the [OPEN] button.**
The front panel closes.

Recording on Memory Stick

Using ATRAC3 audio compression technology, this deck compresses the music data played on the built-in CD player, radio, external CD changer and other external inputs (such as portable players), and records the data on the MG Memory Stick.

CDs being played on the deck can be recorded to a memory stick as digital data. Music from the radio, CD changers, external inputs (such as portable players) is to a memory stick in analog. MP3/WMA files cannot be recorded.

As this deck supports SCMS (Serial Copy Management System), MG Memory Stick recording from media (such as CD-R and CD-RW) digitally recorded from music CDs is not possible. Recording data of copy-proof music CDs is not possible either.



Caution

- Unrecorded contents, deleted music and vocal data caused by problems, malfunctions and defects of this deck will not be warranted.
- Use of your recordings other than for the personal entertainment is strictly prohibited by the copyright law without permission from the copyright holder.
- Unreproducible recordings should be test recorded first in order to ensure all music and vocal data are recorded properly.
- Do not turn ON/OFF the power this deck or ignition switch while recording. The recording will be interrupted and the data may be damaged.

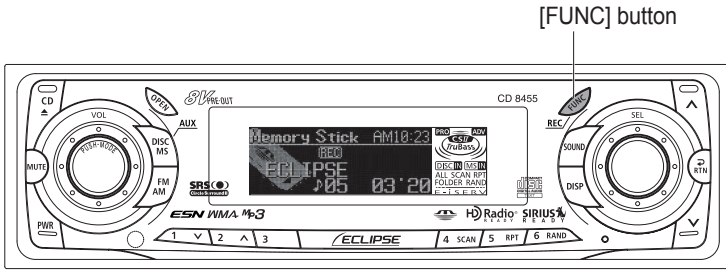

1 Insert the MG Memory Stick.

When attempting to record from a CD, make sure to insert the CD. When attempting to record from the radio, etc., make sure to turn ON the desired sound source.

2 Press the [FUNC] button for more than one second.

Recording begins.
When recording a music CD, the CD plays simultaneously.

3 Press the [FUNC] button for more than one second.

Recording stops.



- A track is not recorded if recording is stopped in the middle of the track.
- In case 1 Track was selected at the "Selecting tracks to be recorded" on page 99, select tracks using the [SEL] button and start recording.
- A MG Memory Stick formatted by another this deck may not be able to record data.

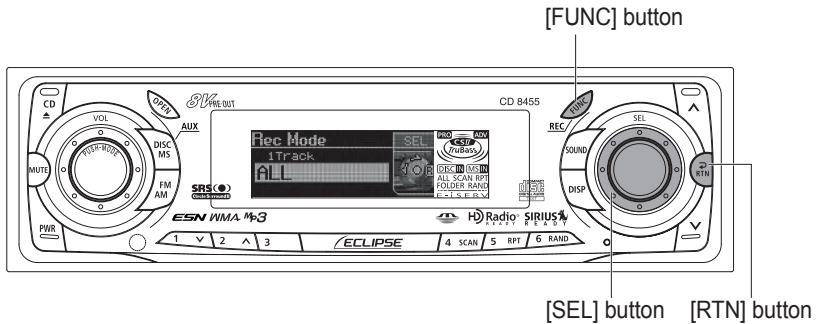

Selecting tracks to be recorded

The track to be recorded can be selected.

- 1 Press the [FUNC] button for less than one second.**
The function mode is activated.
- 2 Turn the [SEL] button to select Memory Stick.**
The selection item is highlighted.
- 3 Press the [SEL] button.**
The Memory Stick setting mode is activated.
- 4 Turn the [SEL] button to select REC Mode.**
The selection item is highlighted.
- 5 Press the [SEL] button.**
The REC mode selection mode is activated.
- 6 Turn the [SEL] button to select All or 1 Track.**
The selection item is highlighted.
ALL: Records all tracks in the disc.
1 Track: Records only the selected track.
- 7 Press the [SEL] button.**
The selected settings will take effect.
- 8 Press the [RTN] button.**
At this time, other adjustments can also be made in Memory Stick setting mode.
- 9 Press the [RTN] button.**
At this time, other adjustments can also be made in function mode.
- 10 Press the [FUNC] or [RTN] button to exit function mode.**

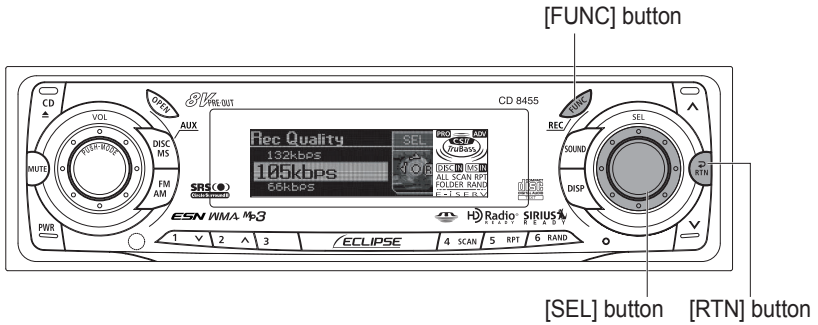

Setting sound quality

The recording sound quality (the recording bit rate) can be set. The recording bit rate may be selected from 66k, 105k and 132k. Sound quality and data size increases as the bit rate increases.

- 1 Press the [FUNC] button for less than one second.**
The function mode is activated.
- 2 Turn the [SEL] button to select Memory Stick.**
The selection item is highlighted.
- 3 Press the [SEL] button.**
The Memory Stick setting mode is activated.
- 4 Turn the [SEL] button to select REC Quality.**
The selection item is highlighted.
- 5 Press the [SEL] button.**
The REC quality selection mode is activated.

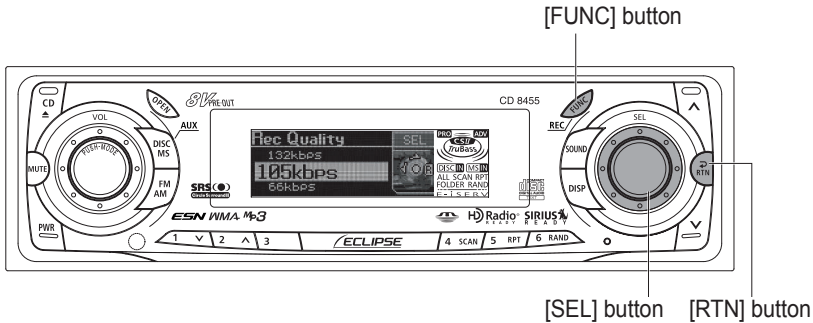

- 6** Turn the **[SEL]** button to select **66kbps**, **105kbps** or **132kbps**.

The selection item is highlighted.

- 7** Press the **[SEL]** button.

The selected settings will take effect.

- 8** Press the **[RTN]** button.

At this time, other adjustments can also be made in Memory Stick setting mode.

- 9** Press the **[RTN]** button.

At this time, other adjustments can also be made in function mode.

- 10** Press the **[FUNC]** or **[RTN]** button to exit function mode.

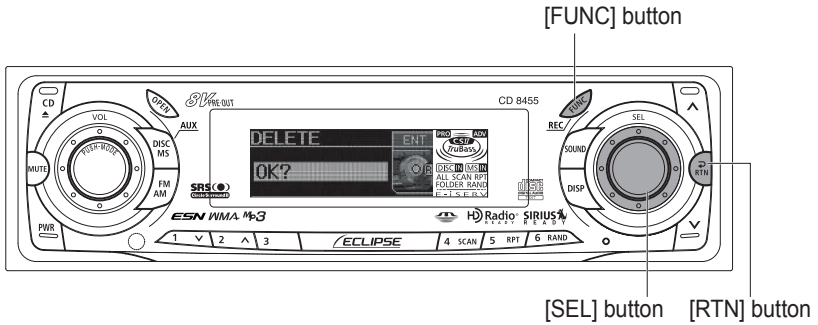

Deleting recorded file

The recorded files being played back can be deleted.

- 1 Press the [FUNC] button for less than one second, when the recording file being played back.**

The function mode is activated.

- 2 Turn the [SEL] button to select Memory Stick.**

The selection item is highlighted.

- 3 Press the [SEL] button.**

The Memory Stick setting mode is activated.

- 4 Turn the [SEL] button to select Delete.**

The selection item is highlighted.

- 5 Press the [SEL] button.**

The file deletion selection screen will be displayed.

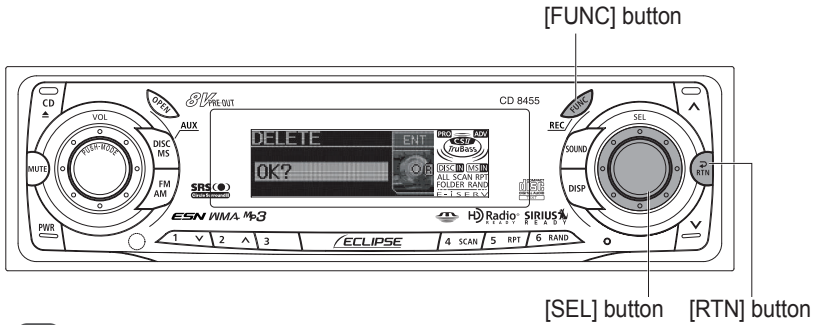

6 Turn the [SEL] button to select the file to be deleted.

7 Press the [SEL] button.

A message confirming file deletion will be displayed.

8 Press the [SEL] button for more than two seconds.

The selected file will be deleted.

9 Press the [RTN] button.

At this time, other adjustments can also be made in Memory Stick setting mode.

10 Press the [RTN] button.

At this time, other adjustments can also be made in function mode.

11 Press the [FUNC] or [RTN] button to exit function mode.

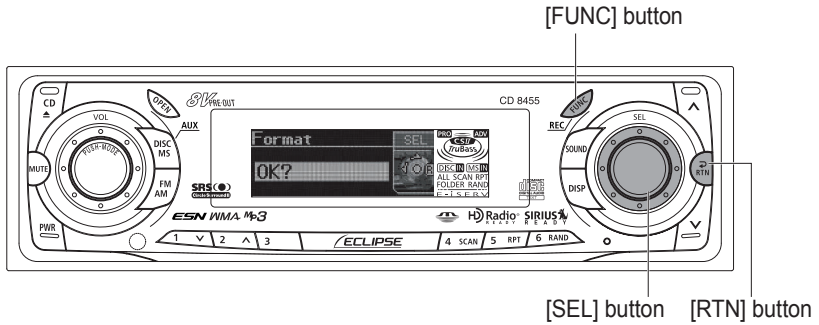

Formatting MG Memory Stick (quick format)

MG memory stick can be formatted.

- 1 Press the [FUNC] button for less than one second.**

The function mode is activated.

- 2 Turn the [SEL] button to select Memory Stick.**

The selection item is highlighted.

- 3 Press the [SEL] button.**

The Memory Stick setting mode is activated.

- 4 Turn the [SEL] button to select Format.**

The selection item is highlighted.

- 5 Press the [SEL] button.**

The format mode is activated, then [OK?] message will appear.

- 6 Press the [SEL] button for more than two seconds.**

MG Memory Stick will be formatted.

- 7 Press the [RTN] button.**

At this time, other adjustments can also be made in Memory Stick setting mode.

- 8 Press the [RTN] button.**

At this time, other adjustments can also be made in function mode.

9 Press the [FUNC] or [RTN] button to exit function mode.

- Do not turn off the power or the ignition switch while formatting. The formatting process will be interrupted and the data may be corrupted.
- When a Memory Stick is formatted, all data on that Memory Stick will be erased. (Includes Memory Stick security recorded data and sound quality data)
- New MG Memory Stick may not be used without formatting. In that case, format (quick format) the stick on this deck so music can be recorded (Hi-Fi directory format). The Memory Stick formatted on a deck other than exclusive MG Memory Stick deck may not be usable on this deck.

How to operate the tuner

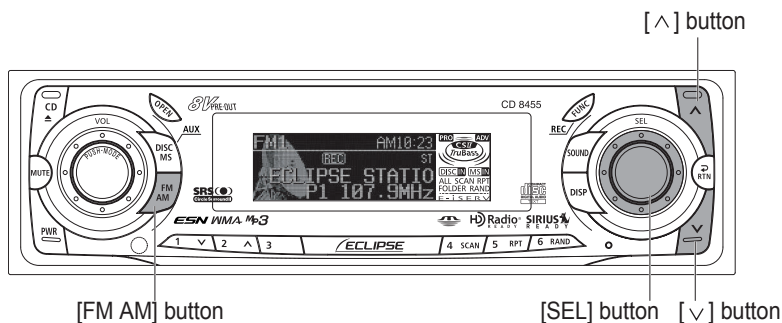

First, press the [FM AM] button to start tuner operation.

There are automatic and manual methods for setting stations in memory. The receiver will accept up to 24 stations in memory: 6 in AM and 18 in FM (6 each for FM1, FM2 and FM3.) (Initial setting)

Tuning to a station

- 1 Press the [FM AM] button for less than one second to switch to the desired FM or AM bands.

Radio bands will switch from FM1 → FM2 → FM3 → AM in order each time the button is pressed.

- 2 Turn the [SEL] button to the left or right to tune to a station.

Turn to the right: Tunes to higher frequencies.

Turn to the left: Tunes to lower frequencies.

- 3 Press the [∧] or [∨] button to start the automatic station search.

[∧] button: Starts searching toward higher frequencies.

[∨] button: Starts searching toward lower frequencies.



- At times, it may be difficult to maintain optimum reception because the antenna affixed to your vehicle is in motion constantly (relative to the broadcast antenna), encountering continuous variation in the received radio signals' strength. Other factors affecting reception include interference from natural obstacles, sign posts, etc.
- When an optional HD Radio tuner unit is connected, digital broadcasts have reception priority. (U.S.A. only)

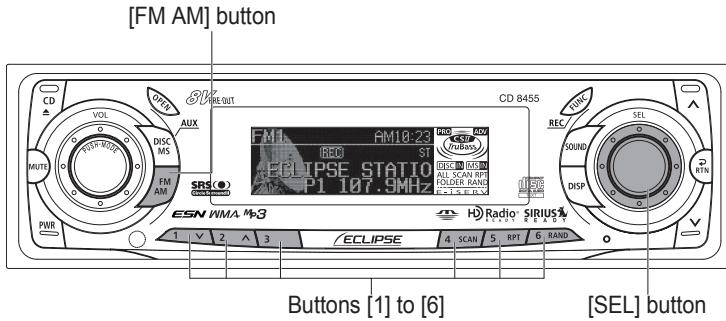

Entering stations into memory automatically (The automatic preset mode: ASM)

- 1 Press the [FM AM] button for less than one second to switch to the desired FM or AM bands.

Radio bands will switch from FM1 → FM2 → FM3 → AM in order each time the button is pressed.

- 2 Press the [SEL] button for more than two second until a beep is heard.

The automatic preset mode starts.

The [ASM ON] indicator on the screen flashes, and stations are automatically entered in memory under buttons [1] to [6].

These buttons are called preset buttons.



ATTENTION

- Pressing the preset buttons ([1] to [6]) allows you to make one-touch station selections. The frequency of selected station is indicated on.
- When a new station is set in memory, the station previously set in memory will be deleted.
- If there are fewer than six receivable stations, the stations set in the remaining buttons will be retained.



Caution

If the vehicle's battery is disconnected (for repairs to the vehicle or for removing the receiver), all stations in memory will be lost. In such a case, set stations in the memory again.

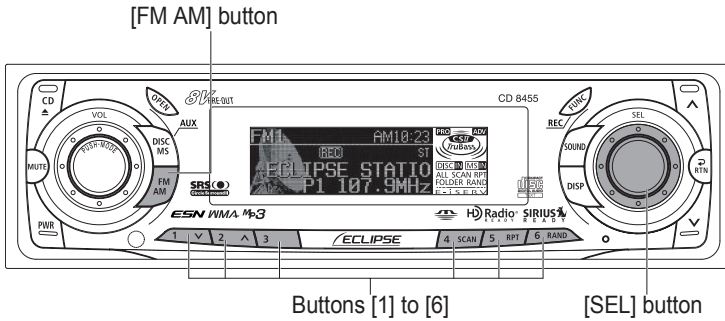

Manually setting stations into memory

This section covers the setting of stations in memory under the numbered buttons.

- 1** Press the [FM AM] button for less than one second to switch between FM and AM.
- 2** Turn the [SEL] button to the right or left to tune to the station to be entered in memory.
- 3** Select any button, from [1] to [6], and press it for more than two seconds.

The tuned station is now memorized and set in the button selected. Repeat the procedure to set additional manually tuned stations in memory, in turn, for buttons [1] to [6]. These buttons are called the preset buttons.



Caution

If the vehicle's battery is disconnected (for repairs to the vehicle or for removing the receiver), all stations in memory will be lost. In such a case, set stations in memory again.

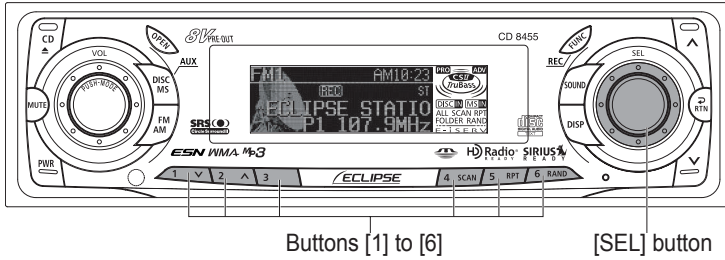

Preset station scan

This function enables reception of all the stations in the preset buttons for five seconds each.

- 1 Press the [SEL] button for less than two seconds.**

[P SCAN] will appear on the display, and stations stored under preset buttons [1] through [6] will be played for five seconds each.

- 2 To stop the preset scan mode at a desired station, press the [SEL] button again.**

The receiver will stay tuned to the desired station.

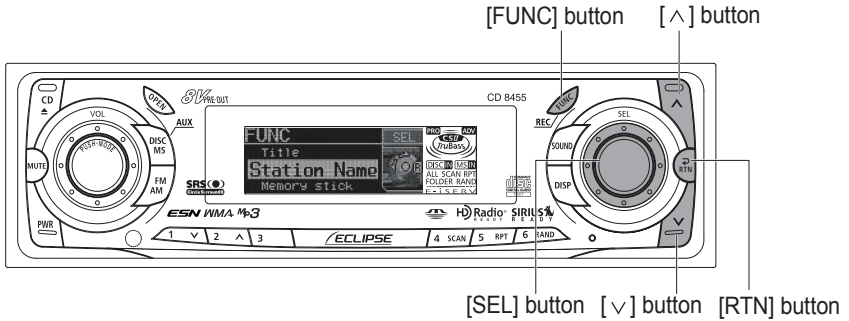

Setting a station name

Station name settings can be changed.

- 1 Press the [FUNC] button for less than one second while in the tuner mode.**

The function mode is activated.

- 2 Turn the [SEL] button to select Station Name.**

The selected item will be highlighted.

- 3 Press the [SEL] button.**

The station name setting mode is activated.

- 4 Press the [^] button to select the character type.**

Pressing the button will switch types from [ABC] (upper-case alphabet characters) to, [123] (numeric characters) and then [!"#] (symbols).

- 5 Press either [SEL] or [v] button to select the position in which to enter the character.**

The character will be inserted where the cursor is flashing:

[SEL] button: Moves the cursor to the right.

[v] button: Advances the cursor to the left. Pressing and holding the [v] button moves the cursor to the left.

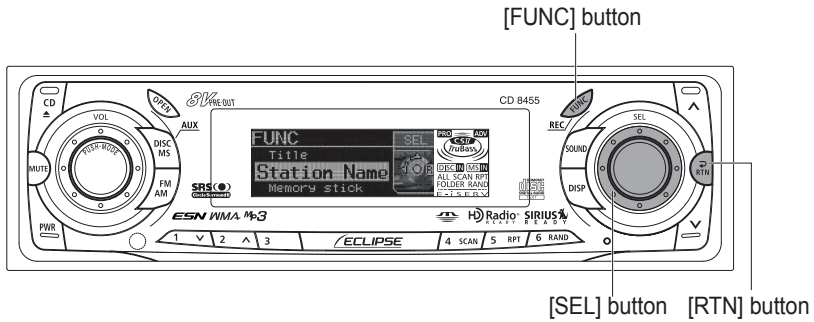

6 Turn the [SEL] button to the left or right to select characters and press the [SEL] button.

Turn to the right: Advances the character forward in its type.

Turn to the left: Moves the character backward in its type.

[Upper-case alphabet characters] Initial value [A] [Right direction]

→A→B→C→⋯→X→Y→Z

[Numeric characters] Initial value [1] [Right direction]

→1→2→3→⋯→8→9→0

[Symbol] Initial value [!] [Right direction]

→!→"→#→\$→%→&→'→(→)→*→+→,→-→.→/→:→;→<→=→>→?→@→'→_



ATTENTION

- To change the type of character to be entered, repeat steps 3 and 4.
- A maximum of 10 characters may be entered per station name.
- A maximum of 50 station names may be stored.

7 Press the [RTN] button.

At this time, other adjustments can also be made in function mode.

8 Press the [FUNC] or [RTN] button to exit function mode.

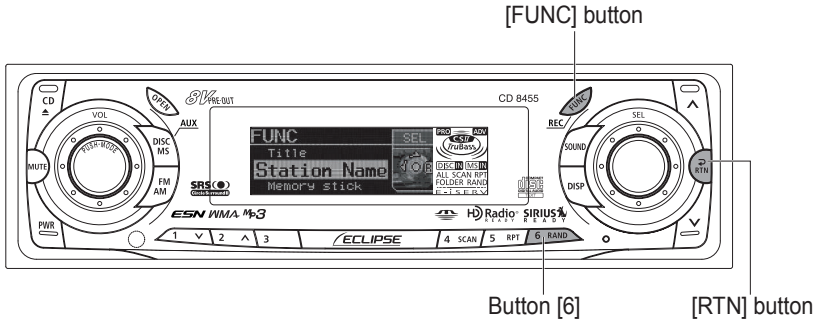

Deleting a station name

- 1 Press the [FUNC] button for less than one second while in the tuner mode.**
The function mode is activated.
- 2 Turn the [SEL] button to select Station Name.**
The selected item will be highlighted.
- 3 Press the [SEL] button.**
The station name that is displayed at this point will be deleted.
- 4 Hold the [6] button down for more than two seconds.**
The station name has now been deleted.
- 5 Press the [RTN] button.**
At this time, other adjustments can also be made in function mode.
- 6 Press the [FUNC] or [RTN] button to exit function mode.**

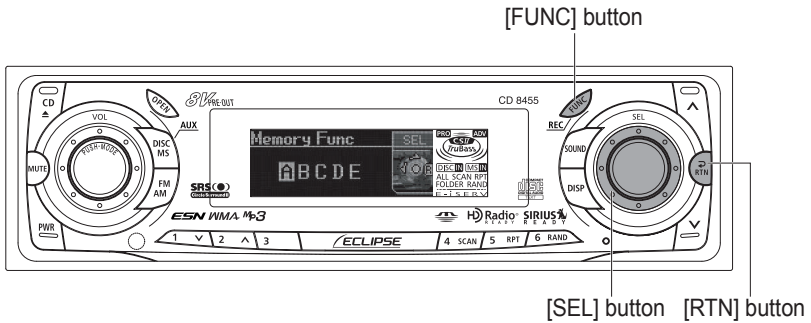

Changing the number of bands

The number of bands can be changed by changing the memory allocations. The number of bands is fixed for each pattern and the number of CD titles that can be set is also changed at the same time.

- 1 Press the [FUNC] button for less than one second while in the tuner mode.**

The function mode is activated.

- 2 Turn the [SEL] button to select Memory Func.**

The selected item will be highlighted.

- 3 Press the [SEL] button.**

The mode will change to memory allocation address selection mode.

4 Turn the [SEL] button to select an address from A to E.

The patterns switch between the following. The characters for the selected item are highlighted.

MEMORY A (standard)	AM/FM: 1/3, CD title memory: 30 titles
MEMORY B	AM/FM: 2/5, CD title memory: 40 titles
MEMORY C	AM/FM: 1/3, CD title memory: 60 titles
MEMORY D	AM/FM: 2/5, CD title memory: 80 titles
MEMORY E	AM/FM: 3/8, CD title memory: 100 titles



If an optional HD radio tuner unit is connected, the number of AM/FM bands is 1/3.

5 Press the [SEL] button.

The memory allocation address changes.

6 Press the [RTN] button.

At this time, other adjustments can also be made in function mode.

7 Press the [FUNC] or [RTN] button to exit function mode.

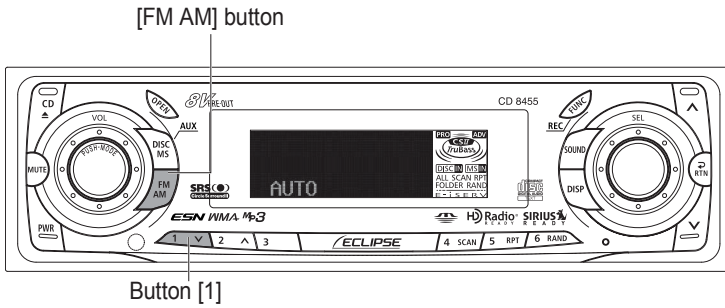

Changing the reception sensitivity for automatic scanning

The deck lets you select the reception sensitivity to be used for automatic scanning of stations. The two sensitivity modes available for this deck are AUTO mode and DX mode.



When an optional HD Radio tuner unit is connected, reception sensitivity is set to the AUTO Mode. The DX Mode is unavailable. (U.S.A. only)

VIII

AUTO Mode	During automatic scanning, the reception sensitivity switches automatically to one of two levels. Initially the reception sensitivity is set to the low level so that only stations with strong signals are received. If no stations could be received, the reception sensitivity is increased so that stations with weaker signals can also be received.
DX Mode	Because the reception sensitivity for automatic scanning is set to the high level from the start, even stations with weaker signals can be received. (Signal crossover may result in some stations being hard to hear.)

- 1** Check that the deck is in standby mode.
- 2** Press and hold button [1], then the [FM AM] button, and hold both for more than three seconds.

The mode switches between AUTO mode and DX mode each time the buttons are pressed.

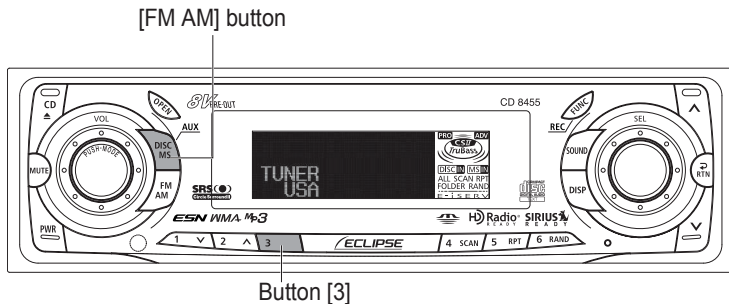

Changing the radio band location

The location for the radio bands used between the North American region and the Asia/Australia/Latin region can be switched. The default setting is USA (North America).



ATTENTION

When an optional HD Radio tuner unit is connected, radio band location is set to USA. Other radio band locations are unavailable. (U.S.A. only)

- 1** Check that the deck is in standby mode.
- 2** Press and hold button [3], then the [FM AM] button, and hold both for more than three seconds.

The radio band switches in the order shown below each time the buttons are pressed.

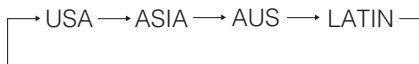

After this, the broadcast stations will be searched for automatically and stored in buttons [1] to [6].

FM reception characteristics

In general, FM has much better tonal quality than AM. However, FM and FM stereo reception encounter several characteristic problems not encountered with AM. FM is more difficult to receive than AM in a moving vehicle. The following are explanatory notes on what to expect from FM reception and on how to get satisfactory performance.

FM reception differs from AM

A characteristic of transmitted signals is that lower frequencies travel further. FM frequencies are much higher than AM's (similar to a ray of light): they won't bend but they will reflect. Often, they will be interrupted by tall buildings, mountains, etc., taking direct and indirect paths to your vehicle's antenna. The distance at which FM stations can be received satisfactorily is usually not nearly as far as that which AM stations can be received.

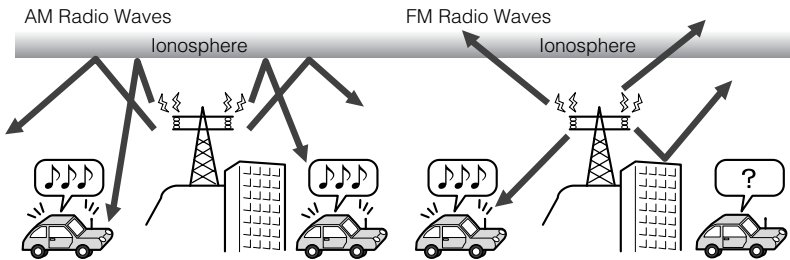

Fading out

In weak signal or "fringe" reception areas, FM stations may fade out completely, or fade in and out. When driving in weak signal areas, such as near hills, through valleys or tunnels, among tall buildings, etc., you may encounter unusual noise interference. **THIS IS NOT A TUNER PROBLEM.** In this case, you can only wait until you are in a better reception area, tune to a stronger station, or reduce the treble level.

Reception area of FM broadcasts

A home receiver can catch weak FM stereo signals through the use of a tall, directional or ultra-sensitive antenna. In a moving vehicle, the area for good reception is limited because of varying conditions encountered while driving, including the types and heights of broadcast antenna structures, signal strength, engine noise, etc. For best reception with manual antenna, extend the antenna mast as far as possible.

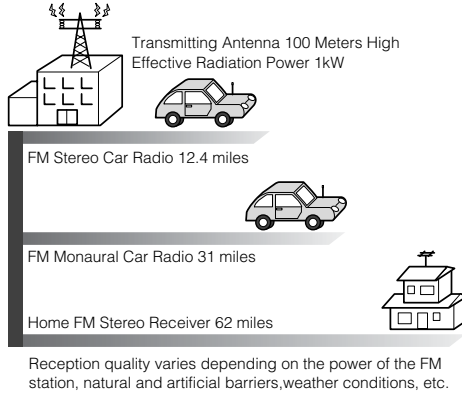

Multipath

The reflection characteristics of FM waves cause another problem called multipath—FM wave signals reflecting off of buildings, mountains, etc. When the antenna receives direct and reflected waves at the same time, distortion of sound in the treble range often occurs, such as static or harsh-sounding voices. **THIS IS NOT A TUNER PROBLEM.** Only moving to another area with a clearer signal path can remedy the situation.

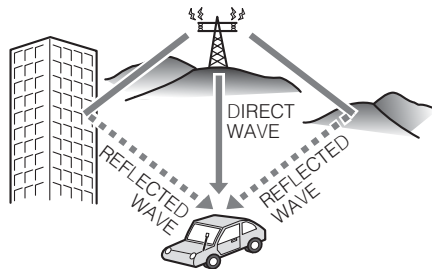

How to operate the Sound Adjustment Mode

About Sound Adjustment Mode

This deck is equipped with two different sound adjustment modes: normal mode and pro mode.

In normal mode, the acoustic characteristics inside the vehicle can be adjusted using comparatively simple settings. In addition, it corresponds to basic sound systems which comprise front speakers, rear speakers, and subwoofer.

In pro mode, the sound quality characteristics can be adjusted item by item using more sophisticated settings than in normal mode. In addition to the 4 speaker system, the adjustments can be made to suit 3-way speaker system where the front speaker, rear speaker and non-fader output can be set to Hi (treble range) Mid (medium range) or Low (bass range). Refer to the table below and to the operations for each mode for details of each mode.

The following adjustments can be made in normal mode and pro mode respectively.

	Normal mode	Pro mode
SRS Circle Surround II	○(See page 129)	×
Parametric equalizer	○(See page 130)	○(See page 150)
Time alignment	○(Simplified) (See page 136)	○(See page 161)
Crossover	○(See page 142)	○(See page 163)
Multi-harmonizer	○(See page 143)	○(See page 166)
Non-fader phase	○(See page 144)	○(See page 167)
Non-fader output	○(See page 145)	○(See page 168)
Speaker layout	×	○(See page 169)
Custom mode	×	○(See page 172)
Sound data	○(See page 146)	○(See page 170)
E-iSERV sound effect customizations (Parametric equalizer)	○(See page 125)	○(See page 125)
E-iSERV sound effect customizations (Time alignment)	○(Simplified) (See page 125)	○(See page 125)

	Normal mode	Pro mode
E-iSERV sound effect customizations (Crossover)	○(See page 125)	○(See page 125)

SRS Circle Surround II (CS II)

Surround sound is produced by combining The CS II (SRS Circle Surround II) mode enables 4-speaker surround sound. The system achieves surround sound by combining SRS TruBass, which uses the difference between two different frequencies to boost bass tones, and SRS Circle Surround, which uses 2ch (L/R) correlation to expand the sound.

SRS  is a trademark of SRS Labs, Inc.

Circle Surround II technology is incorporated under license from SRS Labs, Inc.

Circle Surround II, CSII TruBass, SRS and  symbol are trademarks of SRS Labs, Inc.

Parametric equalizer

A variety of materials are used inside a vehicle to manufacture the seats and windows, and because these materials absorb and reflect sound in different ways, the parametric equalizer lets you adjust the peaks and dips of the frequency characteristics inside the vehicle to compensate for this.

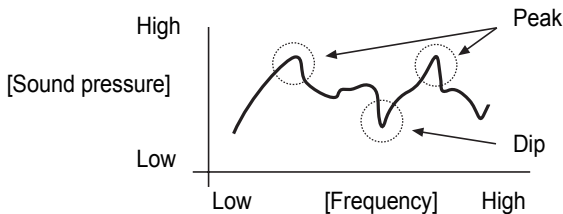

An "equalizer" is a function that corrects these peaks and dips in order to flatten the frequency characteristics. However with a normal graphic equalizer, the median frequency and the Q (sharpness and band width) are fixed, so that when neighboring bands are corrected, there is a limit to the amount by which distortion in the peak and dip characteristics can be corrected.

A "parametric equalizer" lets you adjust the median frequency, Q (sharpness and band width) and gain to variable levels, so that you can make fine adjustments to spot areas of the frequency band.

[Parametric equalizer characteristics]

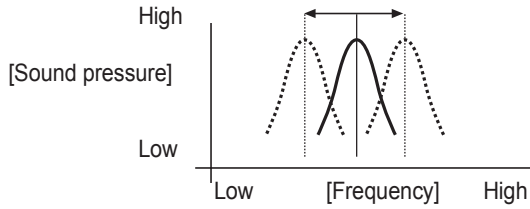
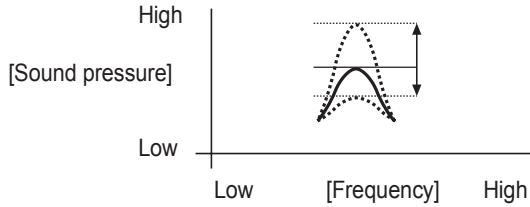
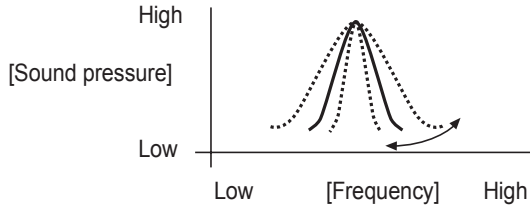
1 Median frequency can be varied.**2 Gain can be varied.****3 Q (sharpness/band width) can be varied.**

In the deck's normal mode, 7-bands can be adjusted with a parametric equalizer. In the pro mode, 5 bands in the high frequency range and 5 bands in the mid to low-frequency ranges can be adjusted with a parametric equalizer, when using 3-way speakers. When using a four-speaker system, 5 bands for the front and 5 bands for the rear can be adjusted separately.

Time Alignment

With vehicle audio systems, the installation position of the speakers and the position of the listener mean that the distances from the listener to the left and right speakers are almost always different. These differences in the distance from the listener to each speaker in turn means that the time taken for the sound to reach the listener is different for each speaker. The result of this is that the phases of each speaker (biases) become mismatched and the sound becomes unnatural, as though the sound stage is not wide enough. The "time alignment" function corrects the time taken for the sound waves to reach the listener in order to set the optimum phase for the listening position so that the sound becomes more expansive as though it is being listened to on a sound stage.

The basic adjustment method involves measuring the actual distances to each speaker and calculating the differences in distance relative to the most distant speaker in order to derive the delay time for the sound from each speaker.

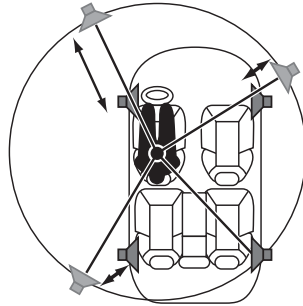

When this deck is in normal mode, a simplified time alignment function is available. You can use this function to adjust only four parameters (position selector, vehicle type, tweeter settings and rear speaker position settings), and so you can make basic time alignment settings without measuring the actual distances to each speaker. In addition, in pro mode you can adjust the time delays and levels for each individual speaker based on the actual speaker layout.

Crossover

The frequency band that is stored by audio media such as CDs is a fairly wide range from 20 Hz to 20 kHz, and it is difficult for a single speaker to be able to play back all frequencies in such a wide range.

Because of this, several speakers can be used, with different frequency bands (such as treble, medium and bass) allotted to each speaker so that wide frequency ranges can be played back.

The "Crossover" function is used to allot the frequency ranges that are to be played back by each speaker in accordance to the installed speaker units and the layout of the speakers, in order to obtain the maximum level of performance from the speakers and to provide the most stable frequency characteristics.

The crossover function includes a high-pass filter (HPF) for playing back treble sounds, and a low-pass filter (LPF) for playing back bass sounds. In addition, the HPF and LPF are used in combination in order to play back sounds in the mid range.

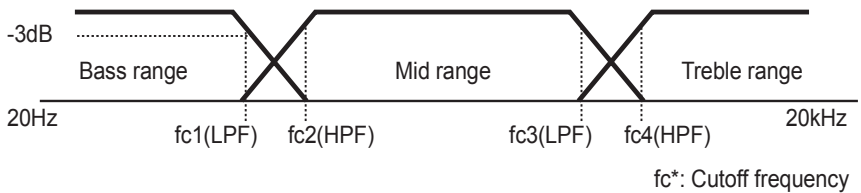

For example, when adjusting the HPF, frequencies that are lower than the specified frequency are progressively dampened, rather than simply not being played back at all. The "slope" adjustment function is the function that is used to adjust these dampening characteristics.

The slope characteristics of a filter are such that with larger slope values (for example 12 dB/oct), the slope becomes steeper, and so the amount of sound mixing in with neighboring bands becomes less so that only the target band is played back. However, it also causes the merging of sound between speakers to become poorer and can result in greater distortion.

- The crossover function is a filter that allocates specified frequency bands.
- A high-pass filter (HPF) is a filter that cuts out frequencies that are lower than the specified frequency (bass range) and allows higher frequencies (treble range) to pass through.

- A low-pass filter (LPF) is a filter that cuts out frequencies that are higher than the specified frequency (treble range) and allows lower frequencies (bass range) to pass through.
- The slope is the signal level at which frequencies that are one octave higher or one octave lower are dampened. The larger the slope value, the greater the slope. In addition, when "PASS" is selected, the slope is eliminated (sound does not pass through the filters), so that the crossover function has no effect.

When this deck is in normal mode, it corresponds to basic speaker systems which comprise front speakers, rear speakers, and subwoofer. In such cases, the crossover can be used to apply the HPF to the front and rear speakers and the LPF to the sub-woofer so that the sound from all speakers merges properly.

In addition to the 4 speaker system, in pro mode, the adjustments can be made to suit speaker system where the front speaker, rear speaker and non-fader output can be switched between Hi, Mid or Low output and the speakers can be combined according to each range (treble range: tweeter, mid range: mid, bass range: woofer) to provide 3-way playback. In this case, the crossover function can be used to adjust the playback ranges so that the HPF is applied to the treble-range speakers, the HPF and LPF is applied to the Mid-range speakers, and the LPF is applied to the bass-range speakers so that the sound from all speakers merges properly.

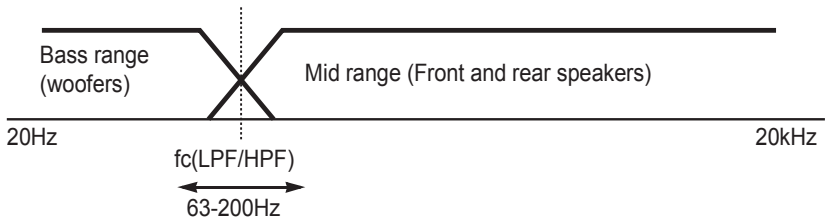

Multi-harmonizer

When original sounds are converted to MP3/WMA and Memory Stick (ATRAC3) format, frequency ranges that are not normally audible to the human ear are compressed. The multi-harmonizer can be used to play back these compressed sounds at as close to their original form as possible so that clear and powerful sound can be enjoyed.

Non-fader phase

The sounds that are output from woofers include sounds that are in the same frequency ranges that are output from the front and rear speakers, and under the various conditions that can occur inside vehicle compartments, some of these sounds may cancel each other out. This phenomenon can be eliminated by changing the phase of the woofer.

The phase of the woofer can be set to normal timing (in which the output timing between the front and rear speakers and the woofer is the same) or reverse timing (in which the output timing between the front and rear speakers and the woofer is different), depending on the vehicle compartment conditions.

Non-Fader output

Depending on your external amplifier, non-fader output may be stereo or mono.

Speaker layout

The speaker layout can be configured as a 3-way or 4-speaker system.

E-iSERV sound effect customizations

The parametric equalizer, time alignment, and crossover setting can be adjusted using this deck, or through the Eclipse web site. (Settings can be stored on CD-R or Memory Stick.)

● Automatic parametric equalizer correction

This can be used to automatically correct distortion in frequency characteristics (peaks and dips) based on the results of measuring the frequency characteristics inside the vehicle. Automatic parametric equalizer correction is carried out in the following steps.

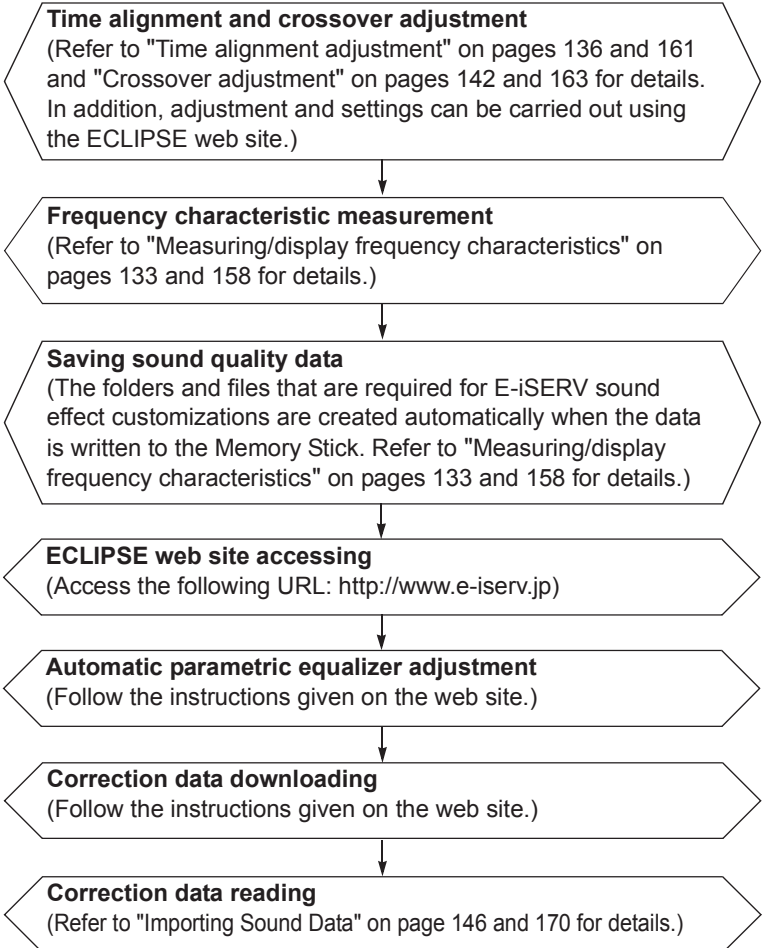

● Time alignment and crossover adjustment

Other adjustments besides adjustment of this deck can be carried out using the ECLIPSE web site. The procedure for doing this is displayed on the screen, and adjustment is comparatively easy using this method. Access the ECLIPSE website and follow the instructions that appear on the screen. After doing this, download the adjusted data for the CD-R or Memory Stick and load it into the deck. (Refer to "Importing Sound Data" on page 146 for details on reading the adjustment data.)

URL: <http://www.e-iserv.jp>

● E-iSERV Custom mode (Pro Mode only)

Using custom modes, E-iSERV sound effect customizations allow you to make adjustments even more precise than those available with the deck alone. Download data adjusted using the custom mode and copy it to a Memory Stick. Next, the adjusted values can be read in the deck's custom mode.

(Refer to "Custom Mode" on page 172)

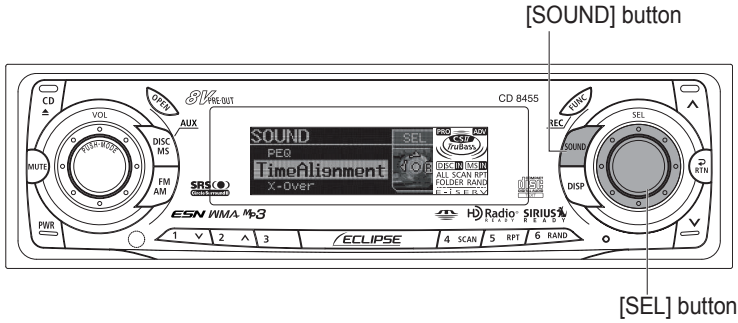

Operations during Normal Mode

1 Press the [SOUND] button.

The mode will change to sound adjustment mode (normal mode). Refer to "Operations during Pro Mode" on page 148 for details on the operating the Pro Mode.



If you press the [SOUND] button during sound adjustment mode, the adjustment mode is canceled and the mode returns to normal music mode.



When switching between Normal Mode and Pro Mode, please make sure that the volume level is set to 0.

2 Turn the [SEL] button to select a setting item.

When the button is turned, the setting item changes in the following order and the selected item is highlighted.

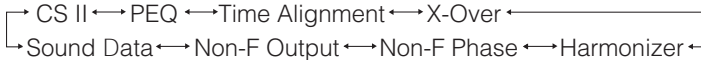

3 Press the [SEL] button.

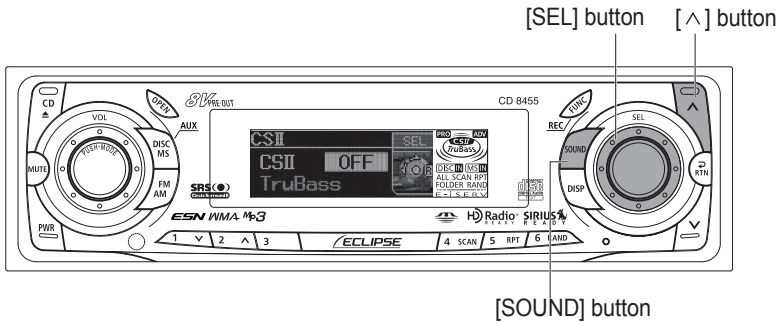

SRS Circle Surround II (CS II)

The system achieves surround sound by combining SRS TruBass, which uses the difference between two different frequencies to boost bass tones, and SRS Circle Surround, which uses 2ch (L/R) correlation to expand the sound.

Setting CSII modes

- 1 Turn the [SEL] button to select CSII.**
The selected item is highlighted.
- 2 Press the [SEL] button.**
The mode will change to CSII mode.
- 3 Turn the [SEL] button.**
Turn the [SEL] button to set CSII modes as follows:

→Low ↔ OFF ↔ HI←

In the Hi and Low settings, Loud and Position can not be changed.

- 4 Press the [SEL] button.**
The selected settings will take effect.
- 5 Press the [^] button.**
When CSII is HI or Low, TruBass can be turned ON/OFF.
- 6 Press the [RTN] button.**
At this time, other adjustments can also be made in normal mode.
- 7 Press the [SOUND] or [RTN] button to exit sound adjustment mode.**



ATTENTION

If the CS II mode has been set (to a setting other than OFF), the BAL (balance) and FAD (fader) settings will be canceled.

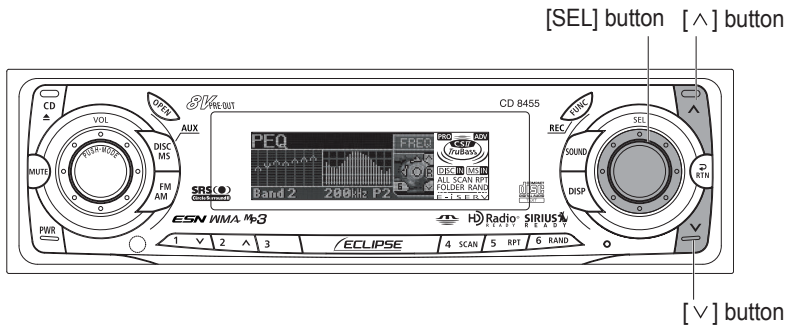

Parametric equalizer adjustment (PEQ)

The parametric equalizer adjusts 7 frequency bands.

1 Turn the [SEL] button to select PEQ.

The selected item is highlighted.

2 Press the [SEL] button.

The mode will change to parametric equalizer adjustment mode.

3 Press the [SEL] button to select the band to be adjusted.

Each time the button is pressed, the selection changes in the following order.

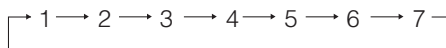

4 Turn the [SEL] button to select the frequency to be adjusted.

When the button is turned, the frequency changes in the following order.

1: 63Hz↔80Hz↔100Hz

2: 125Hz↔160Hz↔200Hz

3: 250Hz↔315Hz↔400Hz↔500Hz

4: 630Hz↔800Hz↔1kHz↔1.25kHz

5: 1.6kHz↔2kHz↔2.5kHz↔3.15kHz

6: 4kHz↔5kHz↔6.3kHz↔8kHz

7: 10kHz↔12.5kHz↔16kHz

5 Press the [^] or [v] button.

This adjusts the frequency level.

[^] button: Increases level.

[v] button: Decreases level.

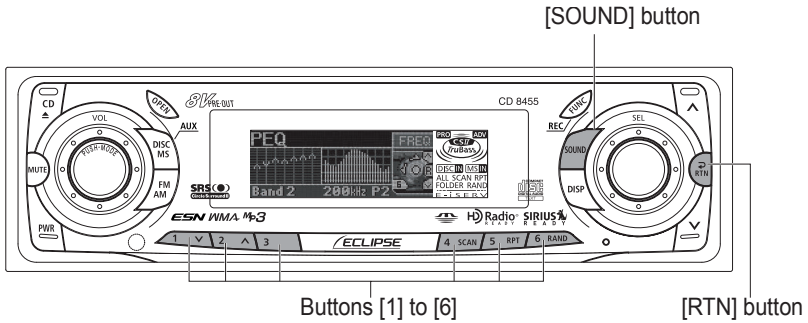

- 6 Press the [6] button to select the Q curve pattern.**
Each time the button is pressed, the Q curve changes in the following order.

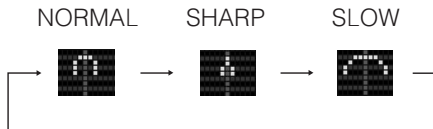

- 7 Repeat the operations in steps 3 to 6 to change the settings for each band.**
- 8 Hold down a button, [1] to [5], for more than two seconds to preset a value.**

The preset value is overwritten by the value set using the above steps.

The time alignment and crossover adjustments will also be stored at this time.

- 9 Press the [RTN] button.**
At this time, other adjustments can also be made in normal mode.
- 10 Press the [SOUND] button to exit sound adjustment mode.**

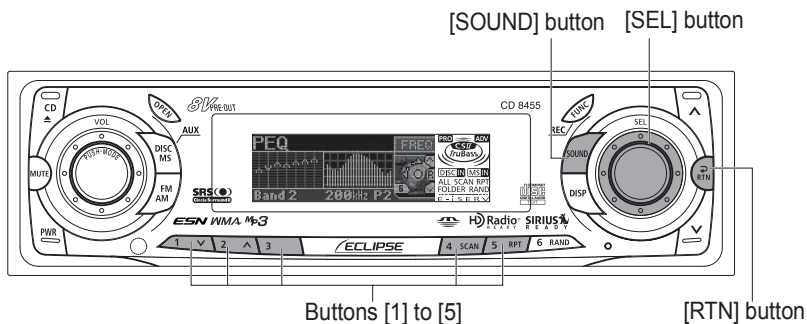

Selecting an equalizer mode from memory

Press a preset button to select the equalizer mode set in memory for the button. The buttons that set equalizer modes in memory are called preset buttons.

- 1** Turn the **[SEL]** button to select **PEQ**.
- 2** Press the **[SEL]** button.
- 3** Select any button, from **[1]** to **[5]**, and press it for less than two seconds.

The preset pattern stored in memory will be retrieved.

- 4** Press the **[RTN]** button.
At this time, other adjustments can also be made in normal mode.
- 5** Press the **[SOUND]** or **[RTN]** button to exit sound adjustment mode.



ATTENTION

When the preset value is changed, the display shows as follows:

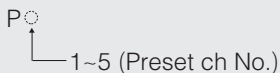

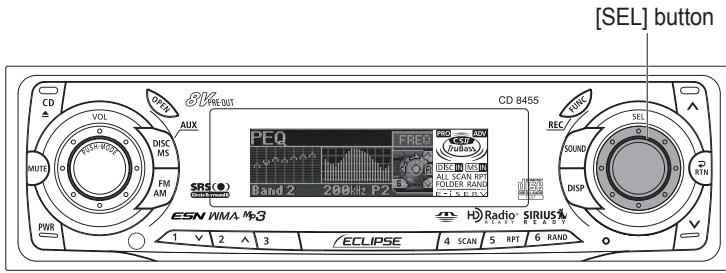

Measuring/display frequency characteristic

Frequency characteristics inside the vehicle can be measured and displayed on the display. The measurement result can be referred to when adjusting parametric equalizer. This result is also necessary to automatically correct parametric equalizer setting using E-iSERV sound effect customizations.



ATTENTION

- Adjust time alignment (see page 136) and crossover (see page 142) before measuring frequency characteristics.
- When measuring frequency characteristics, CSII and Loudness settings are automatically cancelled.

1 Connect the accessory microphone with a RCA connector to the L-CH of the AUX jack of the deck.

The selection item will be highlighted.

2 Turn the [SEL] button to select the PEQ.

Align the microphone with the actual ear position and attach it to the headrest or other appropriate fixture. (Attach the microphone using tape or string.)

3 Press the [SEL] button.

The mode will be change to parametric equalizer adjustment mode.

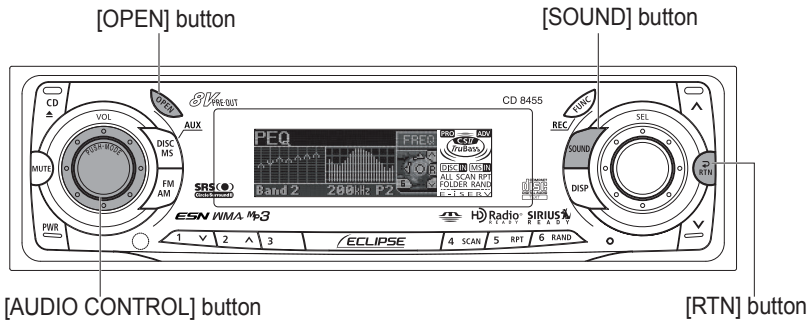

4 Press the [AUDIO CONTROL] button for less than two seconds.

After pushing the button, a 10-second countdown begins. Leave the vehicle during that time.

Pink noise will be output from the speakers and measurement of the frequency characteristics will start. [Measuring] will appear on the display while measurement is in progress. When measurement is complete, the measurement results will appear on the display. You can adjust the volume (by turning the [AUDIO CONTROL] button) and restart measurement while measurement is in progress.

Press the [AUDIO CONTROL] button once more to cancel measurement.

5 Press the [OPEN] button.

6 Insert a Memory Stick.

7 Press the [AUDIO CONTROL] button for more than two seconds.

Measurements can be written to a memory stick and corrected automatically using the E-iSERV website.



ATTENTION

Close all doors and windows while measurement is in progress.



Caution

In order to make measurement of frequency characteristics easier, slight errors may occur in the measurement data under some circumstances when this function is used. In addition, it is not equivalent to the precise measurements that can be made by professional measuring devices.

8 Press the [RTN] button.

At this time, other adjustments can also be made in normal mode.

9 Press the [SOUND] or [RTN] button to exit sound adjustment mode.

ATTENTION

- Sound quality data is written to Memory Stick as follows.

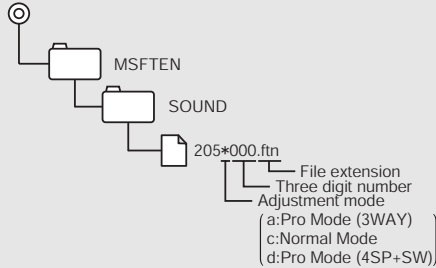

- The folders and files that are required for E-iSERV sound effect customizations are created automatically when the data is written to the Memory Stick.
- Select a file in - when uploading sound quality data to E-iSERV (web site).

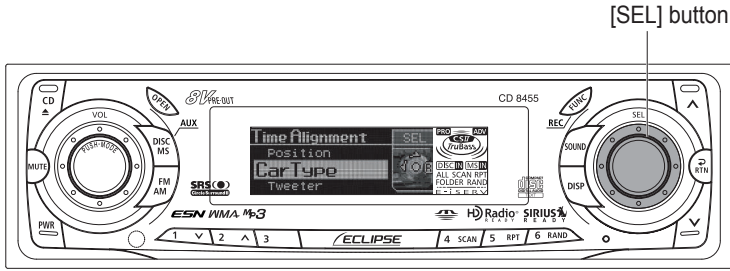

Simplified time alignment settings (Time Alignment)

This function corrects the position characteristics and frequency characteristics in order to delay the signals being output from the various speakers so that the signals from each speaker reach the listening position at the same time.



ATTENTION

- Time Alignment cannot be operated when the CSII is ON.
- Before selecting a position, make sure that CSII is OFF. (For details about turning CSII ON/OFF, see page 129.)

1 Turn the [SEL] button to select Time Alignment.

The selected item will be highlighted.

2 Press the [SEL] button.

The mode will change to time alignment setting mode.

3 Turn the [SEL] button to select a setting item.

When the button is turned, the setting item changes in the following order and the selected item is highlighted.

→ Position ← → Car Type ← → Tweeter ← → Rear SP ←

4 Press the [SEL] button.

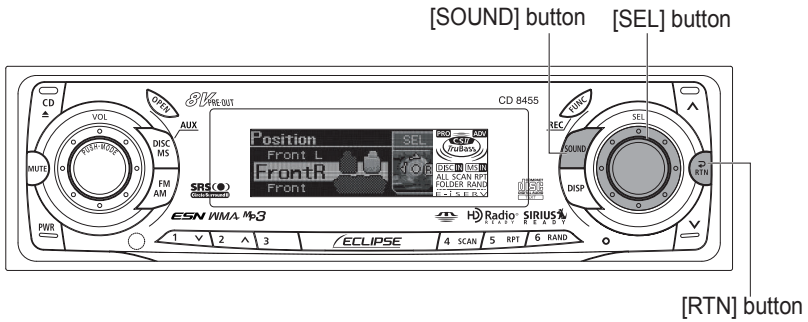

Position selector setting (Position)

When the position of the listener's seat is selected, the time taken for the sound to travel from the speakers to the listener can then be adjusted in order to obtain a more natural sound orientation. This deck allows up to four different positions to be set.

1 Turn the [SEL] button to select Position.

The selected item will be highlighted.

2 Press the [SEL] button.

The mode will change to position selector setting mode.

3 Turn the [SEL] button to select the setting item.

When the button is turned, the setting item changes in the following order and the selected item is highlighted.

→ OFF ↔ Front L ↔ Front R ↔ Front ↔ Rear ←

4 Press the [SEL] button.

The selected settings will take effect.

5 Press the [RTN] button.

Other time alignment items can be set at this time.

6 Press the [RTN] button.

At this time, other adjustments can also be made in normal mode.

7 Press the [SOUND] or [RTN] button to exit sound adjustment mode.



ATTENTION

If the position selector has been set (to a setting other than OFF), the BAL (balance) and FAD (fader) settings will be canceled.

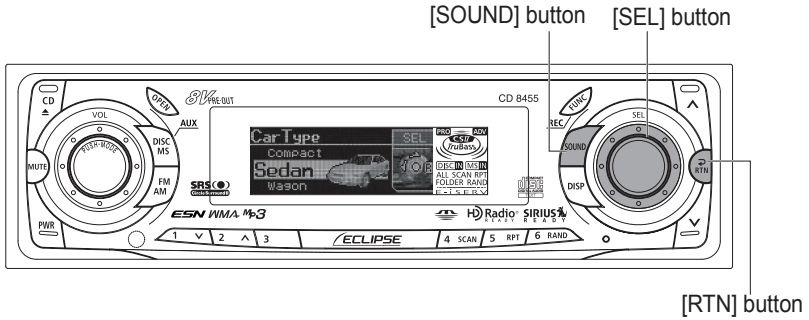

Selecting the type of vehicle (Car Type)

You can select the time alignment settings to match your vehicle from a range of preset settings for different types of vehicle, allowing you to select the optimum time alignment settings automatically.

- 1 Turn the [SEL] button to select Car Type.**
The selected item will be highlighted.
- 2 Press the [SEL] button.**
The mode will change to car type selection mode.

3 Turn the [SEL] button to select the setting item.

When the button is turned, the setting item changes in the following order and the selected item is highlighted.

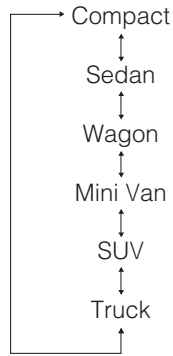
**4 Press the [SEL] button.**

The selected settings will take effect.

5 Press the [RTN] button.

Other time alignment items can be set at this time.

6 Press the [RTN] button.

At this time, other adjustments can also be made in normal mode.

7 Press the [SOUND] or [RTN] button to exit sound adjustment mode.

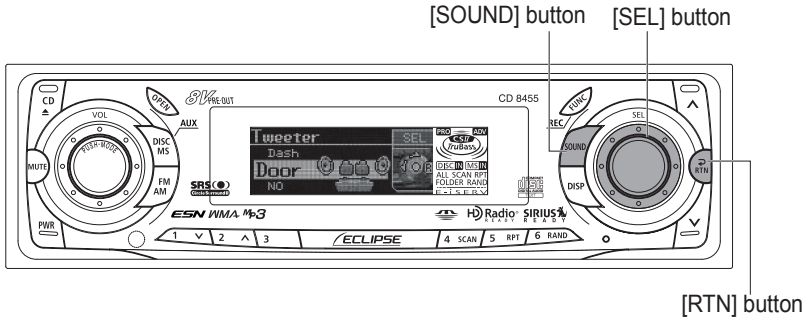

Tweeter settings (Tweeter)

You can select the tweeter installation location and whether or not a tweeter is being used or not, allowing you to select the optimum time alignment settings automatically.

- 1 Turn the [SEL] button to select Tweeter.**
The selected item will be highlighted.
- 2 Press the [SEL] button.**
The mode will change to tweeter setting mode.
- 3 Turn the [SEL] button to select the setting item.**
When the button is turned, the setting item changes in the following order and the selected item is highlighted.

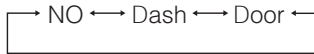

- 4 Press the [SEL] button.**
The selected settings will take effect.
- 5 Press the [RTN] button.**
Other time alignment items can be set at this time.
- 6 Press the [RTN] button.**
At this time, other adjustments can also be made in normal mode.
- 7 Press the [SOUND] or [RTN] button to exit sound adjustment mode.**



If the front speakers have been installed to the dash panel, you can set the tweeter setting to "Dash" even if no tweeter has been installed.

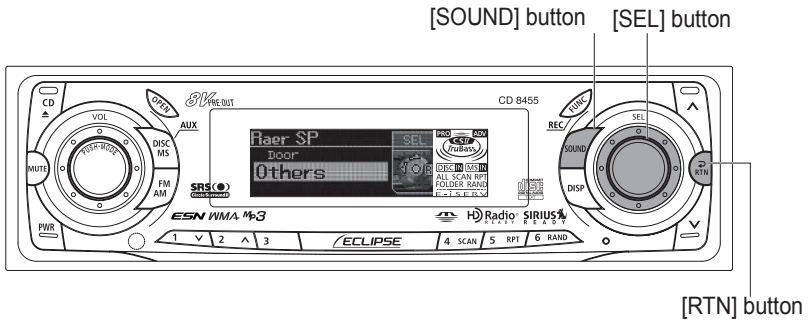

Rear speaker position selection (Rear SP)

You can select the rear speaker installation location, allowing you to select the optimum time alignment settings automatically.

- 1 Turn the [SEL] button to select Rear SP.**
The selected item will be highlighted.
- 2 Press the [SEL] button.**
The mode will change to rear speaker position setting mode.
- 3 Turn the [SEL] button to select the setting item.**
When the button is turned, the setting item changes in the following order and the selected item is highlighted.

Door ↔ Others

- 4 Press the [SEL] button.**
The selected settings will take effect.
- 5 Press the [RTN] button.**
Other time alignment items can be set at this time.
- 6 Press the [RTN] button.**
At this time, other adjustments can also be made in normal mode.
- 7 Press the [SOUND] or [RTN] button to exit sound adjustment mode.**

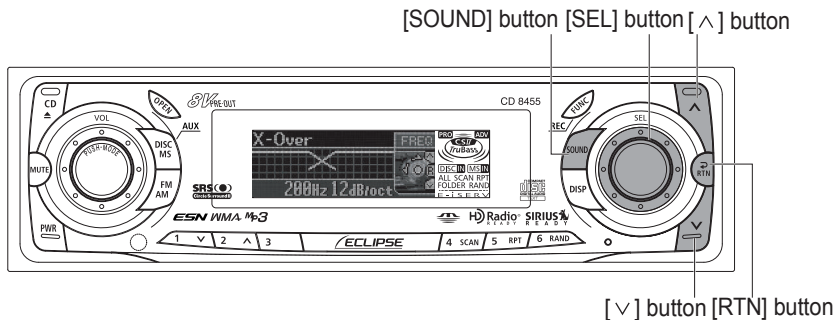

Crossover adjustment (X-Over)

The frequencies for the front and rear speaker high-pass filter (HPF) and woofer low-pass filter (LPF) can be set within a range of 63 to 200 Hz. (This is the same as the HPF and LPF cutoff frequencies.)

- 1 Turn the [SEL] button to select X-Over.**
The selected item will be highlighted.
- 2 Press the [SEL] button.**
The mode will change to crossover setting mode.
- 3 Turn the [SEL] button to select the cut-off frequency.**
When the button is turned, the frequency changes in the following order.
63Hz ↔ 80Hz ↔ 100Hz ↔ 125Hz ↔ 160Hz ↔ 200Hz ↔
- 4 Press the [^] or [v] buttons to set the slope.**
[^] button : The slope becomes more gentle.
[v] button : The slope becomes steeper.
The slope can be set to "PASS", "6dB/oct", "12dB/oct", "18dB/oct" or "24dB/oct".



ATTENTION

If no woofer has been connected, set the slope adjustment to "PASS".
(If slope is set to a setting other than PASS, the low frequency range will not be output from the speakers.)

- 5 Press the [RTN] button.**
At this time, other adjustments can also be made in normal mode.
- 6 Press the [SOUND] or [RTN] button to exit sound adjustment mode.**

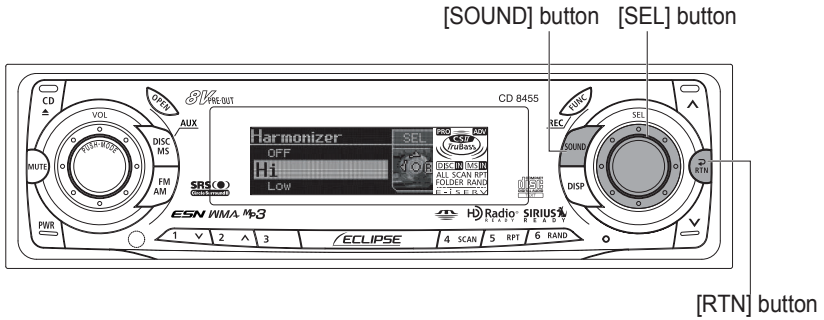

Multi-harmonizer settings (Harmonizer)

This function uses harmonic synthesis to restore the high-frequency component that is lost as a result of the compression process so that better sound can be obtained during MP3 /WMA or Memory Stick (ATRAC3) playback.

1 Turn the [SEL] button to select Harmonizer.

The selected item will be highlighted.

2 Press the [SEL] button.

The mode will change to multi-harmonizer setting mode.

3 Turn the [SEL] button to select the setting item.

When the button is turned, the setting item changes in the following order and the selected item is highlighted.

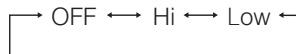

Hi: High effectiveness

Low: Low effectiveness

4 Press the [SEL] button.

The selected settings will take effect.

5 Press the [RTN] button.

At this time, other adjustments can also be made in normal mode.

6 Press the [SOUND] or [RTN] button to exit sound adjustment mode.

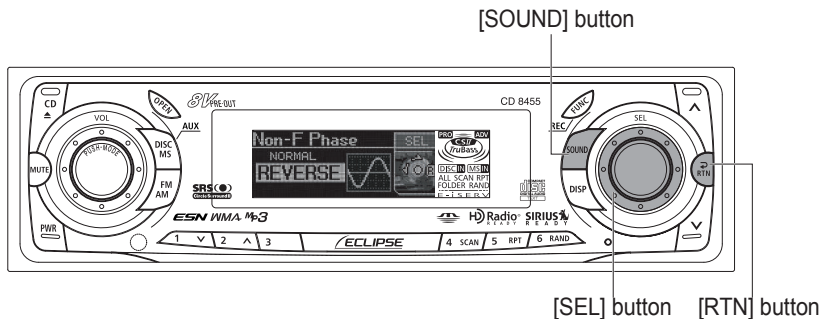

Non-fader phase selection (NON-F Phase)

The merging of sound between the front and rear speakers and the woofer can be improved by selecting the phase.

Switch to a phase which lets the speakers combine without any disharmony.

- 1 Turn the [SEL] button to select Non-F Phase.**
The selected item will be highlighted.
- 2 Press the [SEL] button.**
The mode will change to phase selection mode.
- 3 Turn the [SEL] button to select NORMAL or REVERSE.**
NORMAL: Normal phase
REVERSE: Reverse phase
- 4 Press the [SEL] button.**
The selected settings will take effect.
- 5 Press the [RTN] button.**
At this time, other adjustments can also be made in normal mode.
- 6 Press the [SOUND] or [RTN] button to exit sound adjustment mode.**

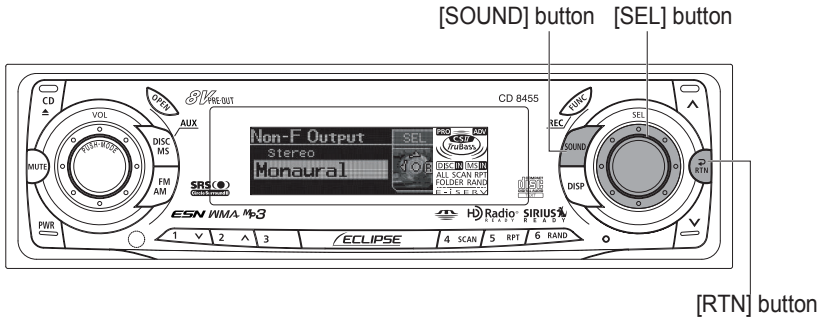

Non-Fader Output

Non-Fader Output can be stereo or mono. Select the method that matches the output method for the sub-woofer system that is connected to the deck.

- 1 Turn the [SEL] button to select Non-F Output.**
The selected item is highlighted.
- 2 Press the [SEL] button.**
The mode will change to Non-F Output.
- 3 Turn the [SEL] button to select Stereo or Monaural.**
- 4 Press the [SEL] button.**
The selected settings will take effect.
- 5 Press the [RTN] button.**
At this time, other adjustments can also be made in normal mode.
- 6 Press the [SOUND] or [RTN] button to exit sound adjustment mode.**

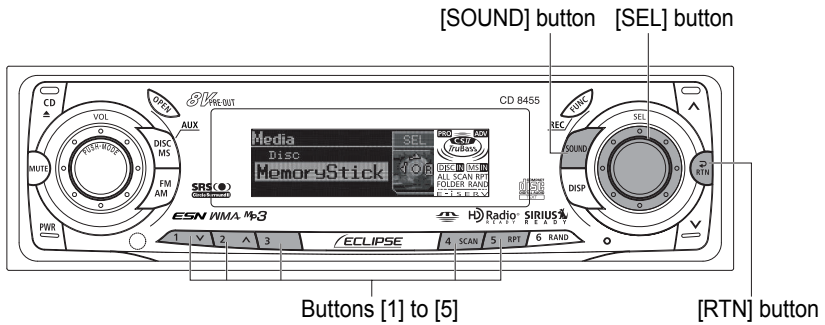

Importing Sound Data

Sound data adjusted by the E-iSERV website can be downloaded to a CD-R or a Memory Stick and imported into the deck.

- 1 Turn the [SEL] button to select Sound Data.**
The selected item is highlighted.
- 2 Press the [SEL] button.**
The mode will change to Sound Data mode.
- 3 Turn the [SEL] switch to select media types.**
When the button is turned, the setting item changes in the following order.
Disc → Memory Stick
- 4 Press the [SEL] button.**
The front panel automatically opens.
- 5 Insert a CD-R or a Memory Stick.**
- 6 Turn the [SEL] button to select the file.**
The selected item will be highlighted.
- 7 Press the [SEL] button.**
- 8 Select from buttons [1] through [5], and press and hold for 2 seconds or more to save to the unit.**
The selected file is written to the selected button.
When using a CD-R, the CD-R will eject automatically when writing is complete.
The display will return to the file selection screen.

9 Press the [RTN] button.

At this time, other adjustments can also be made in normal mode.

10 Press the [SOUND] or [RTN] button to exit sound adjustment mode.When using a Memory Stick:

- Make a folders in the Memory Stick and download the data adjust through E-iSERV (web site) as shown below.

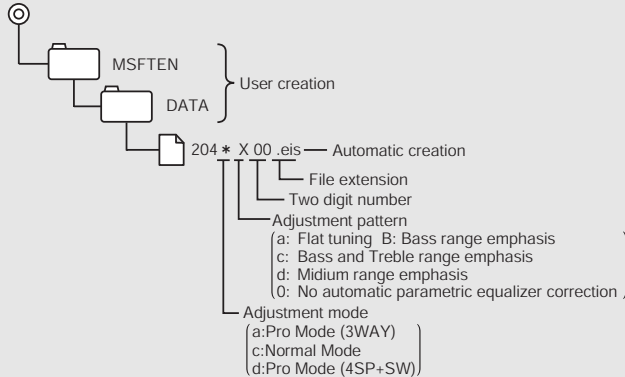

- The files that can be read by this deck are created automatically when you are downloading from the E-iSERV sound effect customizations.

When using a CD-R:

- The deck can only import files from CD-R that have been written in root directories.

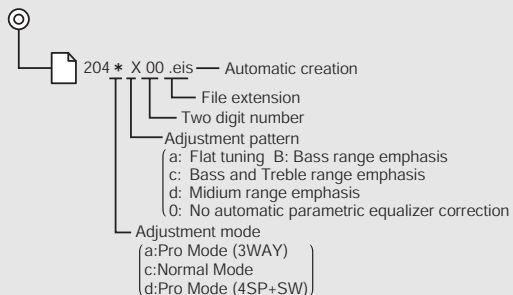

- Disc formats that may be used are as follows:

- CD-ROM (MODE 1)
- CD-ROM (MODE2_FORM 1)

*CD-ROMs written in MODE2_FORM2 cannot be read.

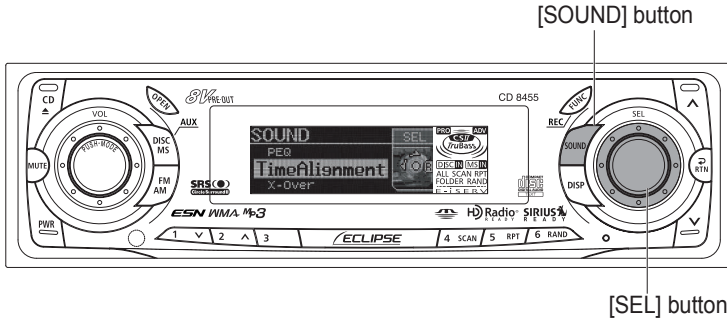

Operations during Pro Mode

1 Press the [SOUND] button for more than five seconds.

The mode switches between normal mode and pro mode each time the button is pressed. During pro mode, "PRO MODE ON" and the scroll display appear in the display.

2 Press the [SOUND] button.

The mode will switch to sound adjustment mode (Pro mode).



ATTENTION

- If the vehicle is equipped with a 3-way speaker system, do not change from pro mode to normal mode. Doing so may cause damage to the speakers.
- If you press the [SOUND] button during sound adjustment mode, the adjustment mode is canceled and the mode returns to audio playback mode.



Caution

When switching between Normal Mode and Pro Mode, please make sure that the volume level is set to 0.

3 Turn the [SEL] button to select a setting item.

When the button is turned, the setting item changes in the following order and the selected item is highlighted.

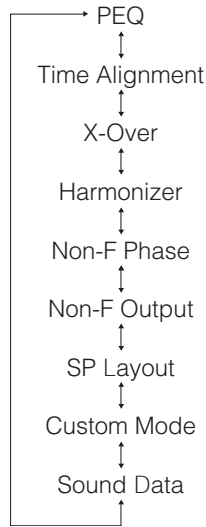
**4 Press the [SEL] button.**

Parametric equalizer adjustment (PEQ)

The parametric equalizer can be set for a both 3-way speaker system or a 4-speaker system. (For details about speaker layout, see page 169.)

Speaker layout: 4-speaker system

When the 4-speaker layout is selected, 5-band parametric equalizers can be adjusted for both the front and rear channels. For each band, the adjustable frequencies are as follows:

Channel	Band	Adjustable frequency (Hz)
Front	F1 F2 F3	63, 80, 100, 125, 160, 200, 250, 315, 400, 500, 630, 800, 1k, 1.25 k, 1.6 k, 2.0 k, 2.5 k, 3.15 k, 4.0 k, 5.0 k, 6.3 k, 8.0 k, 10 k, 12.5 k, 16 k (25 Frequencies)
	F4 F5	200, 250, 315, 400, 500, 630, 800, 1k, 1.25 k, 1.6 k, 2.0 k, 2.5 k, 3.15 k, 4.0 k, 5.0 k, 6.3 k, 8.0 k, 10 k, 12.5 k, 16 k (20 Frequencies)
Rear	R1 R2 R3	63, 80, 100, 125, 160, 200, 250, 315, 400, 500, 630, 800, 1k, 1.25 k, 1.6 k, 2.0 k, 2.5 k, 3.15 k, 4.0 k, 5.0 k, 6.3 k, 8.0 k, 10 k, 12.5 k, 16 k (25 Frequencies)
	R4 R5	200, 250, 315, 400, 500, 630, 800, 1k, 1.25 k, 1.6 k, 2.0 k, 2.5 k, 3.15 k, 4.0 k, 5.0 k, 6.3 k, 8.0 k, 10 k, 12.5 k, 16 k (20 Frequencies)



Identical frequencies within the front channel (bands F1 to F5) cannot be adjusted.

There are 10 Rear & Front-Frequency locations (5 + 5) available for the parametric equalizer. The Parametric Equalizer is divided into two channels Front & Rear.

Any frequency assigned is highlighted in White, and is unavailable for use elsewhere.

Bands selected are grayed out in the diagram to show how they are in use and otherwise unavailable for reuse.

Bands in black are unused (available) and can be assigned to within their respective bands (Rear or Front parametric locations).

Rear Group

R	1	63 Hz	80 Hz	100 Hz	125 Hz	160 Hz	200 Hz	250 Hz	315 Hz	400 Hz	500 Hz	630 Hz	800 Hz	1.0k Hz	1.25k Hz	1.6k Hz	2.0k Hz	2.5k Hz	3.15k Hz	4.0k Hz	5.0k Hz	6.3k Hz	8.0k Hz	10k Hz	12.5k Hz	16k Hz		
R	2	63 Hz	80 Hz	100 Hz	125 Hz	160 Hz	200 Hz	250 Hz	315 Hz	400 Hz	500 Hz	630 Hz	800 Hz	1.0k Hz	1.25k Hz	1.6k Hz	2.0k Hz	2.5k Hz	3.15k Hz	4.0k Hz	5.0k Hz	6.3k Hz	8.0k Hz	10k Hz	12.5k Hz	16k Hz		
R	3	63 Hz	80 Hz	100 Hz	125 Hz	160 Hz	200 Hz	250 Hz	315 Hz	400 Hz	500 Hz	630 Hz	800 Hz	1.0k Hz	1.25k Hz	1.6k Hz	2.0k Hz	2.5k Hz	3.15k Hz	4.0k Hz	5.0k Hz	6.3k Hz	8.0k Hz	10k Hz	12.5k Hz	16k Hz		
							R	4	200 Hz	250 Hz	315 Hz	400 Hz	500 Hz	630 Hz	800 Hz	1.0k Hz	1.25k Hz	1.6k Hz	2.0k Hz	2.5k Hz	3.15k Hz	4.0k Hz	5.0k Hz	6.3k Hz	8.0k Hz	10k Hz	12.5k Hz	16k Hz
							R	5	200 Hz	250 Hz	315 Hz	400 Hz	500 Hz	630 Hz	800 Hz	1.0k Hz	1.25k Hz	1.6k Hz	2.0k Hz	2.5k Hz	3.15k Hz	4.0k Hz	5.0k Hz	6.3k Hz	8.0k Hz	10k Hz	12.5k Hz	16k Hz

F	1	63 Hz	80 Hz	100 Hz	125 Hz	160 Hz	200 Hz	250 Hz	315 Hz	400 Hz	500 Hz	630 Hz	800 Hz	1.0k Hz	1.25k Hz	1.6k Hz	2.0k Hz	2.5k Hz	3.15k Hz	4.0k Hz	5.0k Hz	6.3k Hz	8.0k Hz	10k Hz	12.5k Hz	16k Hz		
F	2	63 Hz	80 Hz	100 Hz	125 Hz	160 Hz	200 Hz	250 Hz	315 Hz	400 Hz	500 Hz	630 Hz	800 Hz	1.0k Hz	1.25k Hz	1.6k Hz	2.0k Hz	2.5k Hz	3.15k Hz	4.0k Hz	5.0k Hz	6.3k Hz	8.0k Hz	10k Hz	12.5k Hz	16k Hz		
F	3	63 Hz	80 Hz	100 Hz	125 Hz	160 Hz	200 Hz	250 Hz	315 Hz	400 Hz	500 Hz	630 Hz	800 Hz	1.0k Hz	1.25k Hz	1.6k Hz	2.0k Hz	2.5k Hz	3.15k Hz	4.0k Hz	5.0k Hz	6.3k Hz	8.0k Hz	10k Hz	12.5k Hz	16k Hz		
							F	4	200 Hz	250 Hz	315 Hz	400 Hz	500 Hz	630 Hz	800 Hz	1.0k Hz	1.25k Hz	1.6k Hz	2.0k Hz	2.5k Hz	3.15k Hz	4.0k Hz	5.0k Hz	6.3k Hz	8.0k Hz	10k Hz	12.5k Hz	16k Hz
							F	5	200 Hz	250 Hz	315 Hz	400 Hz	500 Hz	630 Hz	800 Hz	1.0k Hz	1.25k Hz	1.6k Hz	2.0k Hz	2.5k Hz	3.15k Hz	4.0k Hz	5.0k Hz	6.3k Hz	8.0k Hz	10k Hz	12.5k Hz	16k Hz

Front Group

Example:

If you want the Front channel F1 location to have a parametric frequency of 3.15 kHz.

Because this frequency is in use by F2 you must first assign F2 a new frequency, this will release the band for use in the Front Group F1 at 3.15 kHz.

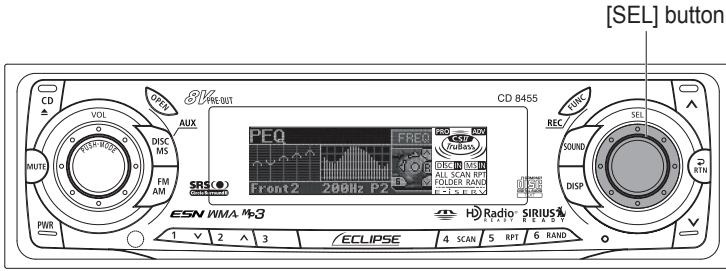

- 1 Turn the [SEL] button to select PEQ.**
The selected item will be highlighted.
- 2 Press the [SEL] button.**
The mode will change to parametric equalizer adjustment mode.
- 3 Press the [SEL] button to select the channel and band to be adjusted.**
Each time the button is pressed, the selection changes in the following order.
F1 → F2 → F3 → F4 → F5 → R1 → R2 → R3 → R4 → R5 →
- 4 Turn the [SEL] button to select the frequency to be adjusted.**
When the button is turned, the frequency changes in the following order.
63Hz ↔ 80Hz ↔ 100Hz ↔ 125Hz ↔ 160Hz ↔ 200Hz ↔
250Hz ↔ 315Hz ↔ 400Hz ↔ 500Hz ↔ 630Hz ↔ 800Hz ↔
1kHz ↔ 1.25kHz ↔ 1.6kHz ↔ 2kHz ↔ 2.5kHz ↔ 3.15kHz ↔
4kHz ↔ 5kHz ↔ 6.3kHz ↔ 8kHz ↔ 10kHz ↔ 12.5kHz ↔
16kHz

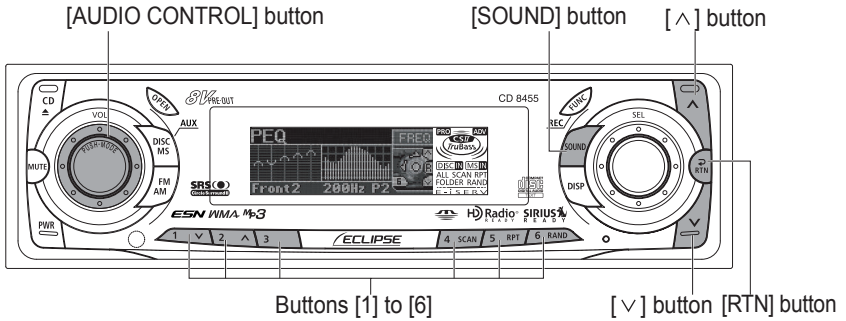

5 Press the [^] or [v] button.

This adjusts the frequency level.

[^] button: Increases level.

[v] button: Decreases level.

6 Press the [6] button to select the Q curve pattern.

Each time the button is pressed, the Q curve changes in the following order.

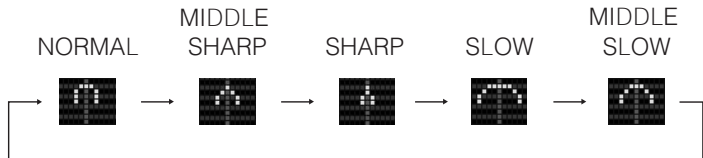

7 Repeat the operations in steps 3 to 6 to change the settings for each channel and band.

The frequencies that have been adjusted for either the channel or band cannot be selected.

8 Hold down a button, [1] to [5], for more than two seconds to preset a value.

The preset value is overwritten by the value set using the above steps.

The time alignment and crossover adjustments will also be stored at this time.

9 Press the [RTN] button.

At this time, other adjustments can also be made in pro mode.

10 Press the [SOUND] or [RTN] button to exit sound adjustment mode.



ATTENTION

When updating software, press the [AUDIO CONTROL] button to measure and display the frequency characteristics.

Speaker layout: 3-way speaker system

Mid-Band (Group-1) Parametric adjustment in 5-Bands of 25 Frequencies.

Hi-Band (Group-2) Parametric adjustment in 5-Bands of 20 Frequencies.

Eclipse has by default assigned arbitrary frequencies for each of the 5-Bands (Hi/Mid for 10 parametric bands total).



Identical frequencies within the Hi group (bands H1 to H5) cannot be adjusted.

Release a frequency from its location, before it can be reassigned (available again for use in another band).

Example: If you want the Hi-Group H1 location to have a parametric frequency of 3.15kHz.

Because this frequency is in use by H2 you must first assign H2 a new frequency, this will release the band for use in the Hi-Group H1 at 3.15kHz.

Mid Group

M 1	63 Hz	80 Hz	100 Hz	125 Hz	160 Hz	200 Hz	250 Hz	315 Hz	400 Hz	500 Hz	630 Hz	800 Hz	1.0k Hz	1.25k Hz	1.6k Hz	2.0k Hz	2.5k Hz	3.15k Hz	4.0k Hz	5.0k Hz	6.3k Hz	8.0k Hz	10k Hz	12.5k Hz	16k Hz
M 2	63 Hz	80 Hz	100 Hz	125 Hz	160 Hz	200 Hz	250 Hz	315 Hz	400 Hz	500 Hz	630 Hz	800 Hz	1.0k Hz	1.25k Hz	1.6k Hz	2.0k Hz	2.5k Hz	3.15k Hz	4.0k Hz	5.0k Hz	6.3k Hz	8.0k Hz	10k Hz	12.5k Hz	16k Hz
M 3	63 Hz	80 Hz	100 Hz	125 Hz	160 Hz	200 Hz	250 Hz	315 Hz	400 Hz	500 Hz	630 Hz	800 Hz	1.0k Hz	1.25k Hz	1.6k Hz	2.0k Hz	2.5k Hz	3.15k Hz	4.0k Hz	5.0k Hz	6.3k Hz	8.0k Hz	10k Hz	12.5k Hz	16k Hz
M 4	63 Hz	80 Hz	100 Hz	125 Hz	160 Hz	200 Hz	250 Hz	315 Hz	400 Hz	500 Hz	630 Hz	800 Hz	1.0k Hz	1.25k Hz	1.6k Hz	2.0k Hz	2.5k Hz	3.15k Hz	4.0k Hz	5.0k Hz	6.3k Hz	8.0k Hz	10k Hz	12.5k Hz	16k Hz
M 5	63 Hz	80 Hz	100 Hz	125 Hz	160 Hz	200 Hz	250 Hz	315 Hz	400 Hz	500 Hz	630 Hz	800 Hz	1.0k Hz	1.25k Hz	1.6k Hz	2.0k Hz	2.5k Hz	3.15k Hz	4.0k Hz	5.0k Hz	6.3k Hz	8.0k Hz	10k Hz	12.5k Hz	16k Hz

H 1	200 Hz	250 Hz	315 Hz	400 Hz	500 Hz	630 Hz	800 Hz	1.0k Hz	1.25k Hz	1.6k Hz	2.0k Hz	2.5k Hz	3.15k Hz	4.0k Hz	5.0k Hz	6.3k Hz	8.0k Hz	10k Hz	12.5k Hz	16k Hz
H 2	200 Hz	250 Hz	315 Hz	400 Hz	500 Hz	630 Hz	800 Hz	1.0k Hz	1.25k Hz	1.6k Hz	2.0k Hz	2.5k Hz	3.15k Hz	4.0k Hz	5.0k Hz	6.3k Hz	8.0k Hz	10k Hz	12.5k Hz	16k Hz
H 3	200 Hz	250 Hz	315 Hz	400 Hz	500 Hz	630 Hz	800 Hz	1.0k Hz	1.25k Hz	1.6k Hz	2.0k Hz	2.5k Hz	3.15k Hz	4.0k Hz	5.0k Hz	6.3k Hz	8.0k Hz	10k Hz	12.5k Hz	16k Hz
H 4	200 Hz	250 Hz	315 Hz	400 Hz	500 Hz	630 Hz	800 Hz	1.0k Hz	1.25k Hz	1.6k Hz	2.0k Hz	2.5k Hz	3.15k Hz	4.0k Hz	5.0k Hz	6.3k Hz	8.0k Hz	10k Hz	12.5k Hz	16k Hz
H 5	200 Hz	250 Hz	315 Hz	400 Hz	500 Hz	630 Hz	800 Hz	1.0k Hz	1.25k Hz	1.6k Hz	2.0k Hz	2.5k Hz	3.15k Hz	4.0k Hz	5.0k Hz	6.3k Hz	8.0k Hz	10k Hz	12.5k Hz	16k Hz

Hi-Group

There are 10 Mid & Hi-Frequency locations (5 + 5) available for the parametric equalizer.

The Parametric Equalizer is divided into two groups Mid & Hi. Any frequency assigned is highlighted in White, and is unavailable for use elsewhere.

Bands selected are grayed out in the diagram to show how they are in use and otherwise unavailable for reuse.

Bands in black are unused (available) and can be assigned to within their respective bands (Mid or Hi parametric locations).

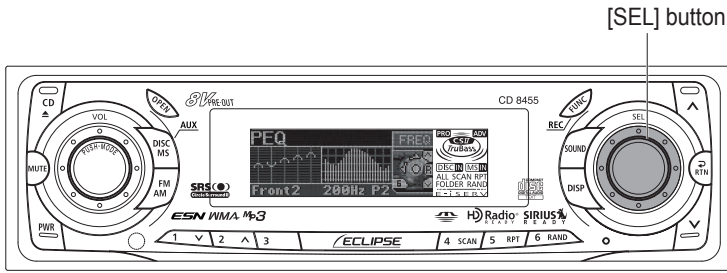

- 1 Turn the [SEL] button to select PEQ.**
The selected item will be highlighted.
- 2 Press the [SEL] button.**
The mode will change to parametric equalizer adjustment mode.
- 3 Press the [SEL] button to select the channel and band to be adjusted.**
Each time the button is pressed, the selection changes in the following order.
Hi1 → Hi2 → Hi3 → Hi4 → Hi5 → Mid1 → Mid2 → Mid3 → Mid4 → Mid5 →
- 4 Turn the [SEL] button to select the frequency to be adjusted.**
When the button is turned, the frequency changes in the following order.
Hi: 200Hz ↔ 250Hz ↔ 315Hz ↔ 400Hz ↔ 500Hz ↔ 630Hz ↔ 800Hz ↔ 1kHz ↔ 1.25kHz ↔ 1.6kHz ↔ 2kHz ↔ 2.5kHz ↔ 3.15kHz ↔ 4kHz ↔ 5kHz ↔ 6.3kHz ↔ 8kHz ↔ 10kHz ↔ 12.5kHz ↔ 16kHz
Mid: 63Hz ↔ 80Hz ↔ 100Hz ↔ 125Hz ↔ 160Hz ↔ 200Hz ↔ 250Hz ↔ 315Hz ↔ 400Hz ↔ 500Hz ↔ 630Hz ↔ 800Hz ↔ 1kHz ↔ 1.25kHz ↔ 1.6kHz ↔ 2kHz ↔ 2.5kHz ↔ 3.15kHz ↔ 4kHz ↔ 5kHz ↔ 6.3kHz ↔ 8kHz ↔ 10kHz ↔ 12.5kHz ↔ 16kHz

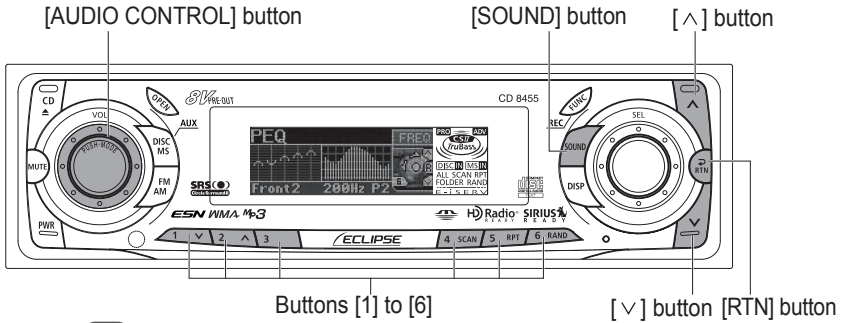

5 Press the [^] or [v] button.

This adjusts the frequency level.

[^] button: Increases level.

[v] button: Decreases level.

6 Press the [6] button to select the Q curve pattern.

Each time the button is pressed, the Q curve changes in the following order.

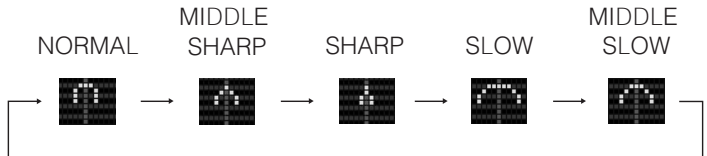

7 Repeat the operations in steps 3 to 6 to change the settings for each channel and band.

The frequencies that have been adjusted for either the channel or band cannot be selected.

8 Hold down a button, [1] to [5], for more than two seconds to preset a value.

The preset value is overwritten by the value set using the above steps.

The time alignment and crossover adjustments will also be stored at this time.

9 Press the [RTN] button.

At this time, other adjustments can also be made in pro mode.

10 Press the [SOUND] or [RTN] button to exit sound adjustment mode.



When updating software, press and hold the [AUDIO CONTROL] button to measure and display the frequency characteristics.

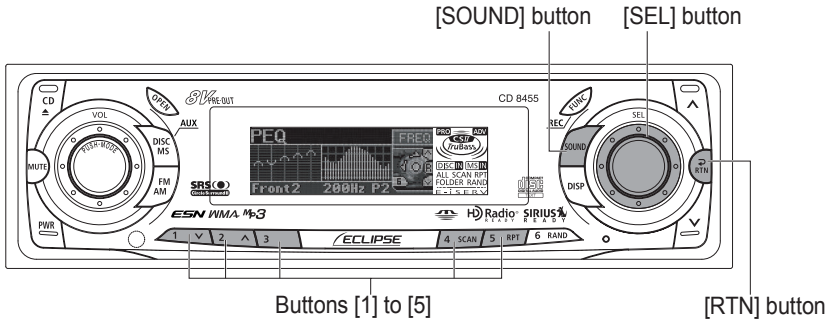

Selecting an equalizer mode from memory

Press a preset button to select the equalizer mode set in memory for the button. The buttons that stores equalizer modes in memory are called preset buttons.

- 1** Turn the [SEL] button to select PEQ.
- 2** Press the [SEL] button.
- 3** Select any button, from [1] to [5], and press it for less than two seconds.

The preset pattern stored in memory will be retrieved.

- 4** Press the [RTN] button.
At this time, other adjustments can also be made in pro mode.
- 5** Press the [SOUND] or [RTN] button to exit sound adjustment mode.



ATTENTION

When the preset value is changed, the display shows as follows:

P
1~5 (Preset ch No.)

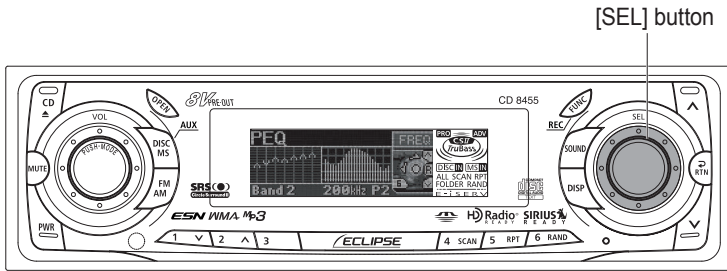

Measuring/display frequency characteristic

Frequency characteristics inside the vehicle can be measured and displayed on the display. The measurement result can be referred to when adjusting parametric equalizer. This result is also necessary to automatically correct parametric equalizer setting using E-iSERV sound effect customizations.



ATTENTION

- Adjust time alignment (see page 161) and crossover (see page 163) before measuring frequency characteristics.
- When measuring frequency characteristics, CSII and Loudness settings are automatically cancelled.

- 1 Connect the accessory microphone with a RCA connector to the L-CH of the AUX jack of the deck.**
The selection item will be highlighted.
- 2 Turn the [SEL] button to select the PEQ.**
Align the microphone with the actual ear position and attach it to the headrest or other appropriate fixture. (Attach the microphone using tape or string.)
- 3 Press the [SEL] button.**
The mode will be change to parametric equalizer adjustment mode.

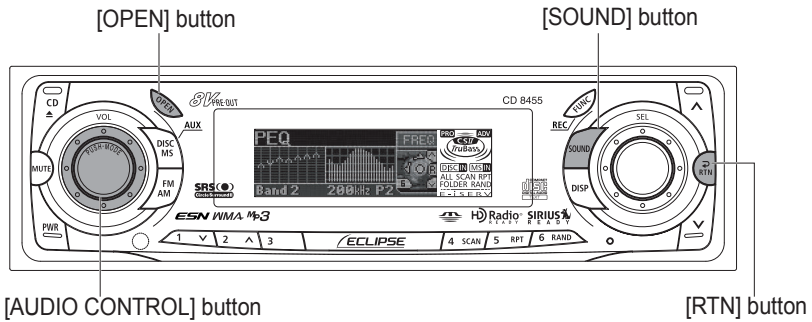

4 Press the [AUDIO CONTROL] button for less than two seconds.

After pushing the button, a 10-second countdown begins. Leave the vehicle during that time.

Pink noise will be output from the speakers and measurement of the frequency characteristics will start. [Measuring] will appear on the display while measurement is in progress. When measurement is complete, the measurement results will appear on the display. You can adjust the volume (by turning the [AUDIO CONTROL] button) and restart measurement while measurement is in progress.

Press the [AUDIO CONTROL] button once more to cancel measurement.

5 Press the [OPEN] button.

6 Insert a Memory Stick.

7 Press the [AUDIO CONTROL] button for more than two seconds.

Measurements can be written to a memory stick and corrected automatically using the E-iSERV website.



ATTENTION

Close all doors and windows while measurement is in progress.



Caution

In order to make measurement of frequency characteristics easier, slight errors may occur in the measurement data under some circumstances when this function is used. In addition, it is not equivalent to the precise measurements that can be made by professional measuring devices.

8 Press the [RTN] button.

At this time, other adjustments can also be made in Pro mode.

9 Press the [SOUND] or [RTN] button to exit sound adjustment mode.

ATTENTION

- Sound quality data is written to Memory Stick as follows.

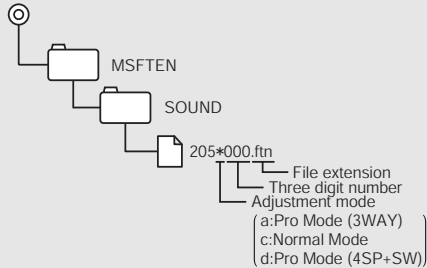

- The folders and files that are required for E-iSERV sound effect customizations are created automatically when the data is written to the Memory Stick.
- Select a file in **[MSFTEN]** - **[SOUND]** when uploading sound quality data to E-iSERV (web site).

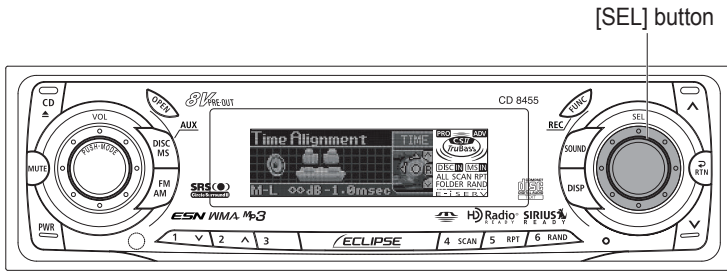

Time alignment adjustment (Time Alignment)

The delay time and level of the sound from each speaker can be adjusted in order to correct any phase mismatches in the sound resulting from the listening position. (For details about speaker layout selection, see page 169.)

1 Turn the [SEL] button to select Time Alignment.

The selected item will be highlighted.

2 Press the [SEL] button.

The mode will change to time alignment adjustment mode.

3 Press the [SEL] button to select the speaker band to be adjusted.

Each time the button is pressed, the selection changes in the following order.

Speaker layout: 3-way speaker system

Hi-L → Hi-R → Mid-L → Mid-R → Low-L → Low-R →

Speaker layout: 4-speaker system

FL → FR → RL → RR → SW →

4 Turn the [SEL] button to select the speaker that is furthest away, and then adjust the delay time for the sound to arrive.

The delay time can be adjusted within 0.0 to 10.0 ms (in units of 0.1 ms).

Turn to the right: Increases the time.

Turn to the left: Decreases the time.

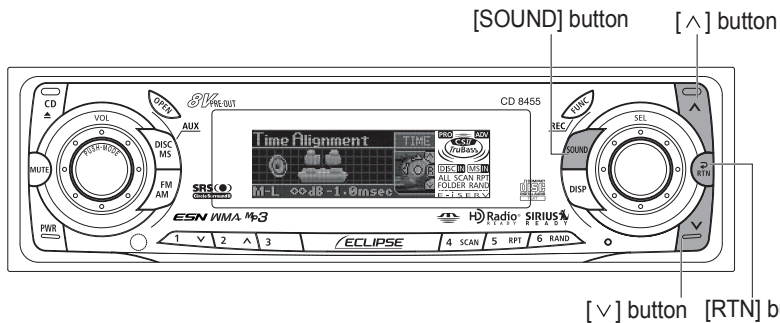

Refer to the following for the method of calculating the delay time.

$$A = (B - C) / 34$$

A: Delay time (ms)

B: Distance from listening position to furthest speaker (cm)

C: Distance from listening position to the speaker to be adjusted (cm)

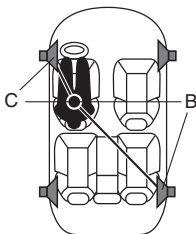

(Example) Listening position: Driver's seat (left)

B: 200 (cm)

C: 50 (cm)

$$\text{Delay time} = [200 \text{ (cm)} - 50 \text{ (cm)}] / 34 = \text{Approx. } 4.4 \text{ (ms)}$$

5 Press the [^] or [v] button.

Adjust the level for each speaker.

[^] button: Increases level.

[v] button: Decreases level.

6 Repeat the operations in steps 3 to 5 to change the settings for each speaker.

7 Press the [RTN] button.

At this time, other adjustments can also be made in pro mode.

8 Press the [SOUND] or [RTN] button to exit sound adjustment mode.

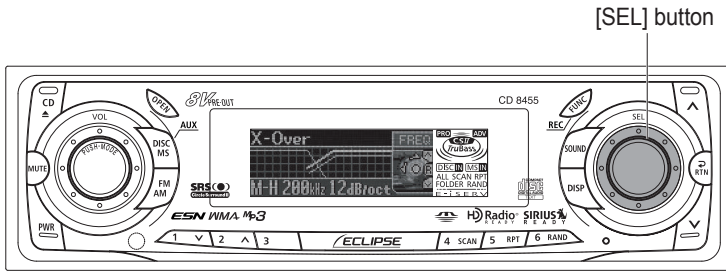

Crossover adjustment (X-Over)

With the 4-speaker system, the frequencies of the front speaker HPF (High Pass Filter) and woofer LPF (Low Pass Filter) can be adjusted. With the 3-way speaker system (a speaker system combining a high range tweeter, a mid range speaker and a low range woofer), the integration between the sound of the speakers is improved by adjusting playback zones using tweeter HPF, mid-range HPF and LPF and woofer LPF.

- 1 Turn the [SEL] button to select X-Over.**
The selected item will be highlighted.
- 2 Press the [SEL] button.**
The mode will change to crossover adjustment mode.
- 3 Press the [SEL] button to select the crossover adjustment channel.**
Each time the button is pressed, the selection changes in the following order.
Speaker layout: 3-way speaker system
Hi → M-LPF → M-HPF → Low →
Speaker layout: 4-speaker system
Front → Rear → Woofer →

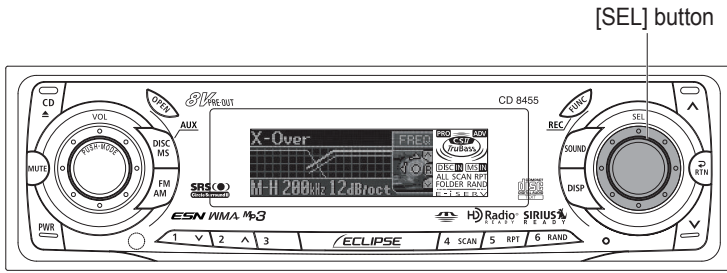

4 Turn the [SEL] button to select the cut-off frequency.

When the button is turned, the frequency changes in the following order.

Speaker layout: 3-way speaker system

Hi / M-LPF:

200Hz ↔ 250Hz ↔ 315Hz ↔ 400Hz ↔ 500Hz ↔ 630Hz ↔
800Hz ↔ 1kHz ↔ 1.25kHz ↔ 1.6kHz ↔ 2kHz ↔ 2.5kHz ↔
3.15kHz ↔ 4kHz ↔ 5kHz ↔ 6.3kHz ↔ 8kHz ↔ 10kHz

M-HPF / Low:

63Hz ↔ 80Hz ↔ 100Hz ↔ 125Hz ↔ 160Hz ↔ 200Hz

Speaker layout: 4-speaker system

Front/Rear:

63Hz ↔ 80Hz ↔ 100Hz ↔ 125Hz ↔ 160Hz ↔ 200Hz ↔
250Hz ↔ 315Hz ↔ 400Hz ↔ 500Hz ↔ 630Hz ↔ 800Hz ↔
1kHz ↔ 1.25kHz ↔ 1.6kHz ↔ 2kHz ↔ 2.5kHz ↔ 3.15kHz ↔
4kHz ↔ 5kHz ↔ 6.3kHz ↔ 8kHz ↔ 10kHz

Woofer:

63Hz ↔ 80Hz ↔ 100Hz ↔ 125Hz ↔ 160Hz ↔ 200Hz

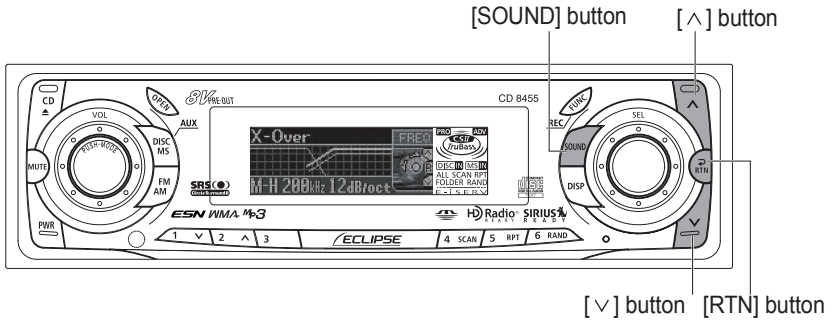

5 Press the [^] or [v] buttons to set the slope.

[^] button : The slope becomes more gentle.

[v] button : The slope becomes steeper.

The slope can be set to "PASS", "6dB/oct", "12dB/oct", "18dB/oct" or "24dB/oct".



ATTENTION

If no woofer has been connected, set the slope adjustment to "PASS".
(If slope is set to a setting other than PASS, the low frequency range will not be output from the speakers.)

6 Repeat the operations in steps 3 to 5 to change the settings for each channel.

7 Press the [RTN] button.

At this time, other adjustments can also be made in pro mode.

8 Press the [SOUND] or [RTN] button to exit sound adjustment mode.

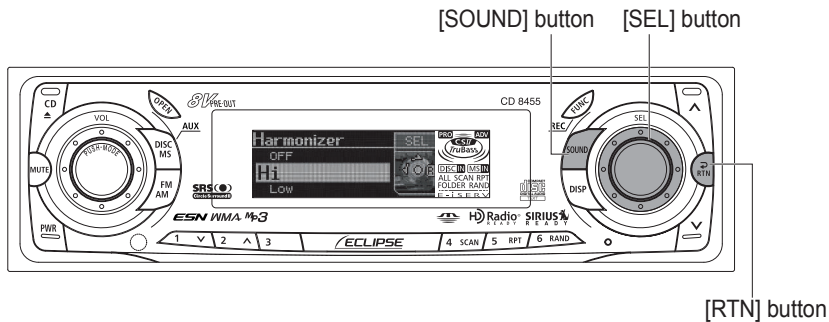

Multi-harmonizer settings (Harmonizer)

This function uses harmonic synthesis to restore the high-frequency component that is lost as a result of the compression process so that better sound can be obtained during MP3 /WMA or Memory Stick (ATRAC3) playback.

1 Turn the [SEL] button to select Harmonizer.

The selected item will be highlighted.

2 Press the [SEL] button.

The mode will change to multi-harmonizer setting mode.

3 Turn the [SEL] button to select the setting item.

When the button is turned, the setting item changes in the following order and the selected item is highlighted.

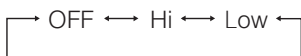

Hi: High effectiveness

Low: Low effectiveness

4 Press the [SEL] button.

The selected settings will take effect.

5 Press the [RTN] button.

At this time, other adjustments can also be made in pro mode.

6 Press the [SOUND] or [RTN] button to exit sound adjustment mode.

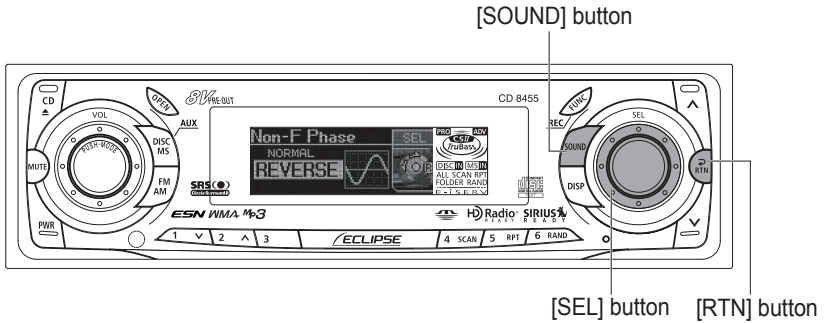

Non-fader phase selection (NON-F Phase)

The merging of sound between the front and rear speakers and the woofer can be improved by selecting the phase. Switch the phase to a phase which lets the speakers combine without any disharmony.

- 1 Turn the [SEL] button to select Non-F Phase.**
The selected item will be highlighted.
- 2 Press the [SEL] button.**
The mode will change to phase selection mode.
- 3 Turn the [SEL] button to select NORMAL or REVERSE.**
The selected item will be highlighted.
NORMAL: Normal phase
REVERSE: Reverse phase
- 4 Press the [SEL] button.**
The selected settings will take effect.
- 5 Press the [RTN] button.**
At this time, other adjustments can also be made in pro mode.
- 6 Press the [SOUND] or [RTN] button to exit sound adjustment mode.**

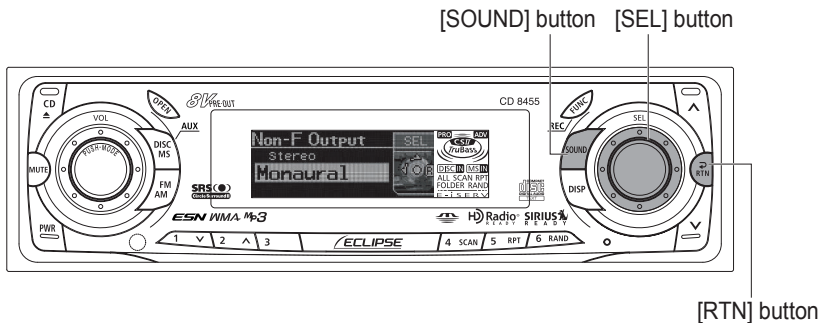

Non-Fader Output

Non-Fader Output can be stereo or mono. Select the method that matches the output method for the sub-woofer system that is connected to the deck.

- 1 Turn the [SEL] button to select Non-F Output.**
The selected item is highlighted.
- 2 Press the [SEL] button.**
The mode will change to Non-F Output mode.
- 3 Turn the [SEL] button to select Stereo or Monaural.**
- 4 Press the [SEL] button.**
The selected settings will take effect.
- 5 Press the [RTN] button.**
At this time, other adjustments can also be made in pro mode.
- 6 Press the [SOUND] or [RTN] button to exit sound adjustment mode.**

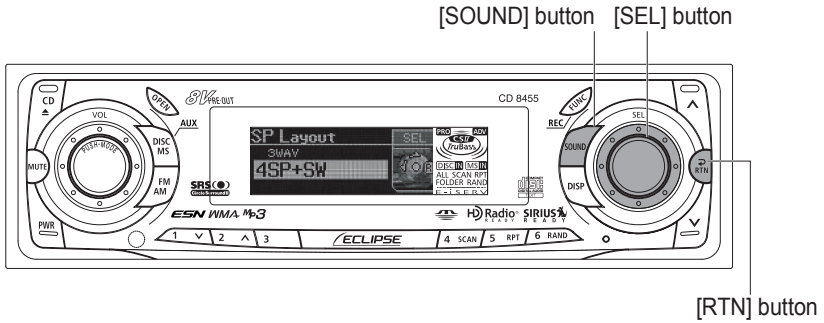

Speaker layout

Depending upon speaker layout, you can switch between 3-way and 4-speaker systems. (Select a system configuration before adjusting PEQ, time alignment or cross over.)

- 1 Turn the [SEL] button to select SP Layout.**
The selected item is highlighted.
- 2 Press the [SEL] button.**
The mode will change to SP Layout mode.
- 3 Turn the [SEL] button to select 3WAY or 4SP + SW**
3WAY: 3WAY speaker system
4SP + SW: 4 speaker and a sub-woofer
- 4 Press and hold the [SEL] button for more than five seconds.**
- 5 The speaker layout confirmation message will be displayed. If the layout is OK, press [SEL].**
Press the [RTN] button to return the speaker layout selection screen.
- 6 Press the [RTN] button.**
At this time, other adjustments can also be made in pro mode.
- 7 Press the [SOUND] or [RTN] button to exit sound adjustment mode.**



ATTENTION

If the vehicle is equipped with the 3-way speaker system, do not change from pro mode to normal mode. Doing so may cause damage to the speakers.



Caution

When switching between 3WAY mode and 4SP + SW mode, please make sure that the volume level is set to 0.

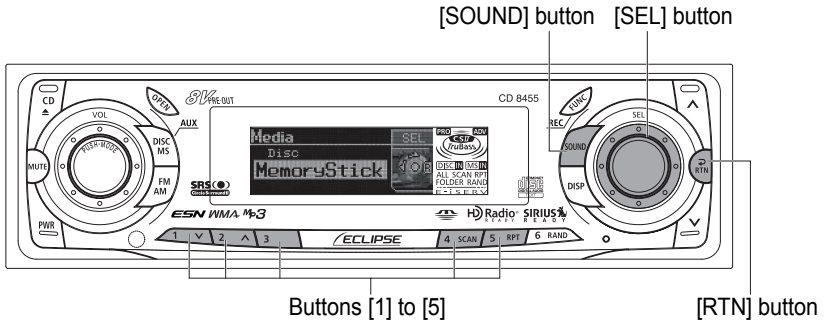

Importing Sound Data

Sound data adjusted by the E-iSERV website can be downloaded to a CD-R or a memory stick and imported into the deck.

- 1 Turn the [SEL] button to select Sound Data.**
The selected item is highlighted.
- 2 Press the [SEL] button.**
The mode will change to Sound Data mode.
- 3 Turn the [SEL] switch to select media types.**
When the button is turned, the setting item changes in the following order.
Disc → Memory Stick
- 4 Press the [SEL] button.**
The front panel automatically opens.
- 5 Insert a CD-R or a Memory Stick.**
- 6 Turn the [SEL] button to select the file.**
When the button is turned, the setting item changes and the selected item is highlighted.
- 7 Press the [SEL] button.**
- 8 Select from buttons [1] through [5], and press and hold for 2 seconds or more.**
The selected file is written to the selected button.
When using a CD-R, the CD-R will eject automatically when writing is complete.
The display will return to the file selection screen.

9 Press the [RTN] button.

At this time, other adjustments can also be made in pro mode.

10 Press the [SOUND] or [RTN] button to exit sound adjustment mode.When using a Memory Stick:

- Make a folders in the Memory Stick and download the data adjust through E-iSERV (web site) as shown below.

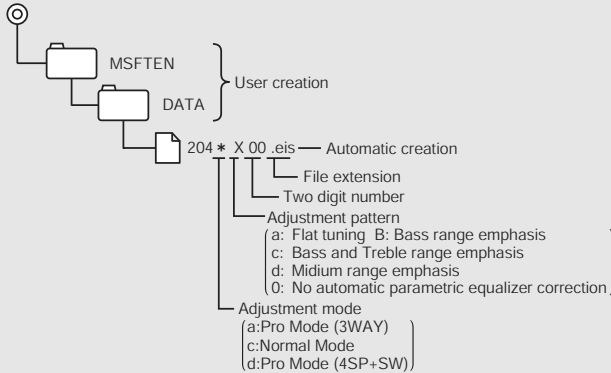

- The files that can be read by this deck are created automatically when you are downloading from the E-iSERV sound effect customizations.

When using a CD-R:

- The deck can only import files from CD-R that have been written with root directories.

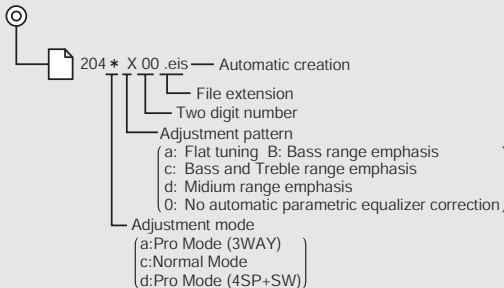

- Disc formats that may be used are as follows:

- CD-ROM (MODE 1)
- CD-ROM (MODE2_FORM 1)

*CD-ROMs written in MODE2_FORM2 cannot be read.

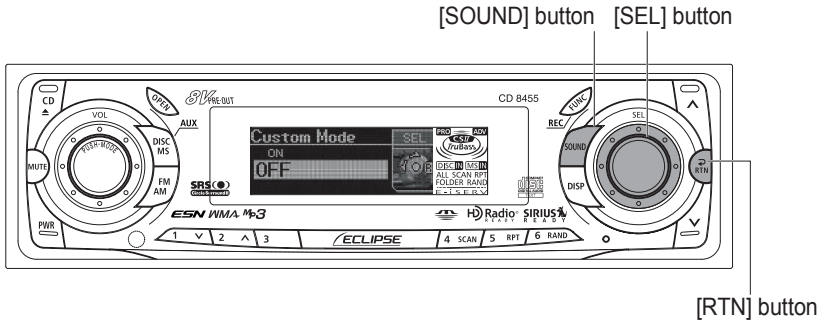

Custom Mode

Values (PEQ, time alignment, cross over value) can be adjusted using the custom mode on the web site. Adjust values following the instructions provided on the E-iSERV operation procedure screen, and download the data to a Memory Stick.

- 1 Turn the [SEL] button to select Custom Mode.**
The selected item is highlighted.
- 2 Press the [SEL] button.**
The mode will change to Custom mode.
Insert a memory stick containing data.
- 3 Turn the [SEL] button to select ON or OFF.**
If a Memory Stick is not inserted, a caution appears instead of ON/OFF.
- 4 Press the [SEL] button.**
- 5 Press the [RTN] button.**
At this time, other adjustments can also be made in pro mode.
- 6 Press the [SOUND] or [RTN] button to exit sound adjustment mode.**



ATTENTION

PEQ, time alignment, and cross over values cannot be adjusted while the custom mode is on. To adjust values, turn the custom mode off.

How to operate the AREA SHOT function (U.S.A. only)

About the AREA SHOT

Using AREA SHOT function, maps to destinations and guidance information can be displayed on your deck if you have set route on the ECLIPSE web site (E-iSERV). Current vehicle position can also be displayed on the map if an optional GPS unit is connected.



The display in this manual may differ from that of the accrual product.

To use the AREA SHOT function

In order to use AREA SHOT, driving instructions such as the direction of travel and the street names of turn intersections must be downloaded from the ECLIPSE website (E-iSERV) and imported into the CD8455.

The process is as follows:

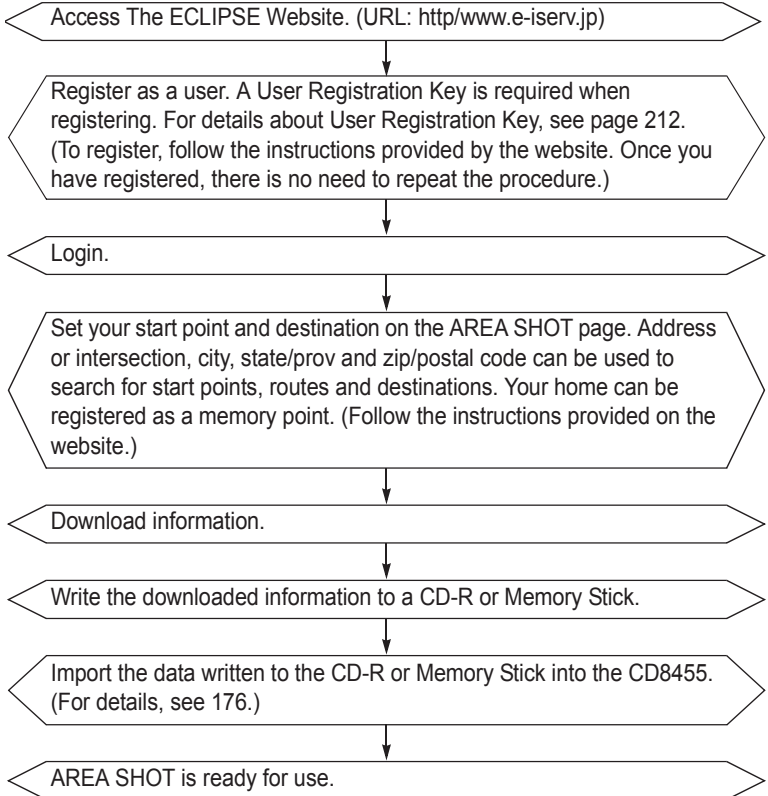

Map data

The map data used by the deck was created based on information provided by Tele Atlas and Geographic Data Technology.

When using the map data, be aware actual road conditions and obey traffic rules.

Copying, publishing or using maps in electronic media without express written consent is forbidden.

GPS (Global Positioning System)

Developed and operated in the United States, GPS(Global Positioning System), is a system that locates current position (longitude and latitude) using radio waves beamed to earth from 3 or 4 GPS satellites.

GPS information may not be available under the following circumstances:

- When GPS satellite radio waves are interrupted by buildings, tunnels, elevated roads, etc.
- When radio waves are interrupted by objects on or near the GPS antenna.
- In some instances, wave transmission is interrupted by the U.S. tracking control center during maintenance or upgrades.
- When a digital cellular phone (1.5 GHz) is used near a GPS antenna.



- Make sure to follow the actual traffic regulations when driving.
- Driving your vehicle while only following guidance point instructions may lead to traffic violations and cause accidents.
- Do not modify this system for use other than that specified herein. Also, do not deviate from the installation procedures described herein, ECLIPSE will not be held liable for damages including, but not limited to serious injury, death or property damage resulting from installations that enable unintended operation.

X

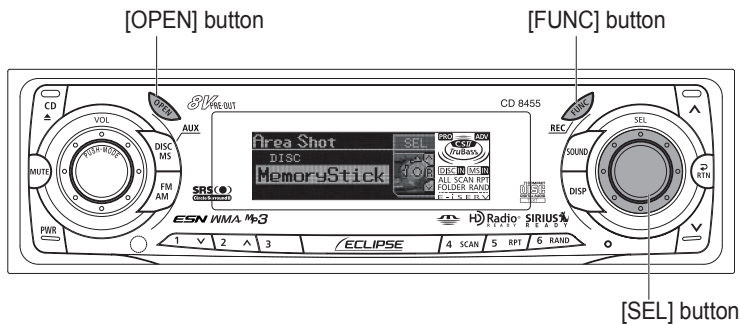

Reading the AREA SHOT data

The AREA SHOT data that has been downloaded from E-iSERV (web site) to a Memory Stick or CD-R can be loaded into the deck and saved there.

1 Press the [FUNC] button for less than one second.

The function mode is activated.

2 Turn the [SEL] button to select AreaShot.

3 Press the [SEL] button.

The media selection screen appears.

4 Turn the [SEL] button to select Disc or Memory Stick.

The selected item will be highlighted.

5 Press the [SEL] button.

The panel opens automatically.

6 Insert the Memory Stick or CD-R to be used for read the Area Shot data.

7 Press the [OPEN] button to close the front panel.

If a CD-R has been inserted, the panel closes automatically. After the panel is closed, files in the CD-R or Memory Stick are read. While files are being read, the [READING...] message appears. If there are no correct files on the CD-R or Memory Stick, "No DATA" is displayed.

8 Turn the [SEL] button to select the saved file.

The selection file name is highlighted.

9 Press the [SEL] button.

The selected file will be saved. "READING" is displayed while data is being imported. When reading has finished, [Completed] will appear on the display and then it will return to the display for selecting the function mode.



When using a Memory Stick:

Data downloaded from the ECLIPSE web site (E-iSERV) is saved to folders created in the CD-R or Memory Stick as shown below.

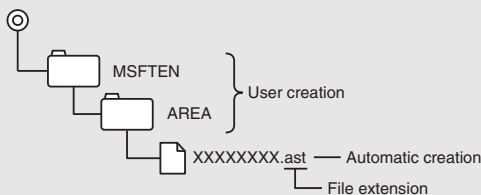

- Files that can be imported into your deck are created automatically when downloaded from E-iSERV.
- All of searched route maps and guidance information are stored in these automatically created files.
- The file name can be changed using 8 alphanumeric characters (space cannot be used).

When using a CD-R:

- The deck can only import files from CD-R that have been written in root directories.

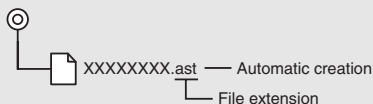

- Disc formats that may be used are as follows:
 - CD-ROM (MODE 1)
 - CD-ROM (MODE2_FORM 1)
 - *CD-ROMs written in MODE2_FORM2 cannot be read.
- The file name can be changed using 8 alphanumeric characters (space cannot be used).



Do not turn the power or ignition switch off while reading. Interrupting reading process might corrupt the data.

X

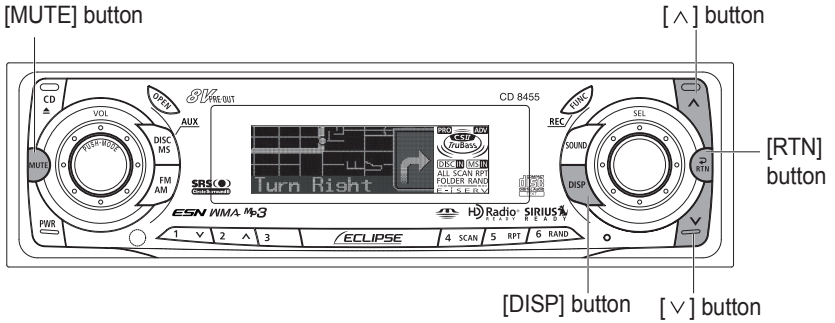

Changing the AREA SHOT mode

1 Press the [MUTE] button for more than one second.

Intersection street names and turning directions are displayed on the screen. Pressing and holding the MUTE button (for 1 second or more) a second time closes the Area Shot mode.



ATTENTION

- Pressing any button other than [^], [v], [DISP] and [RTN] displays the audio control screen enabling audio system operation. If no button is pressed within 6 seconds, the guidance point screen returns.
- If the audio control screen is displayed while the Area Shot mode is ON, pressing the [RTN], [^], [v] or [DISP] buttons displays the guidance point screen.



Caution

- Modes may not be changed if guidance data has not been imported properly.
- Do not look at the screen while driving.

Using the AREA SHOT mode

By manually switching between guidance points, both previous and next guidance points can be confirmed during guidance.

AREA SHOT Screen Configuration

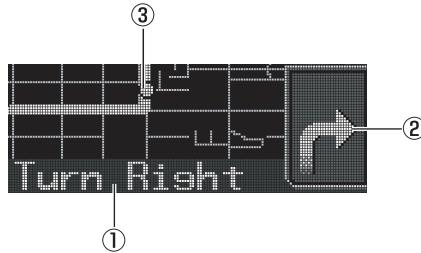

① Guidance information:

Information about guidance points (traveling direction, street names) displayed as a text.

② Arrows:

Indicates direction to the guidance point.

③ Vehicle position marker:

If an optional GPS unit is connected, your vehicle position will be displayed. The vehicle position marker will move on the map in accordance to your vehicle's movement.



The display in this manual may differ from that of the accrual product.

X

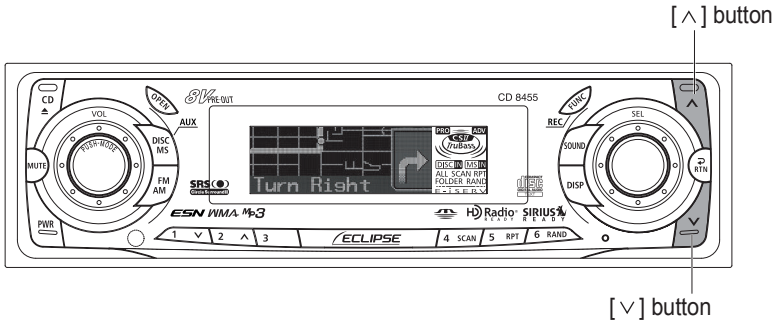

Switching between guidance points

After passing each location described in the guidance, it is necessary to switch manually to the next guidance screen. The previous screen can also be accessed manually and confirmed.

1 Press [^] and [v] to switch between guidance points.

[^]..... To switch to the next guidance point.

[v]..... To switch to the previous guidance point.

With each press of the button, the guidance display changes as follows:



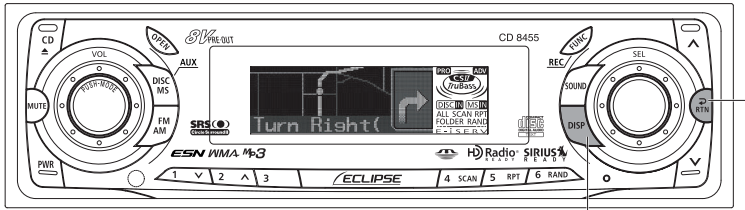

[DISP] button [RTN] button

Re-scrolling through text information

Text information including intersection street names and turn directions can be scrolled across the screen by switching through guidance points. A maximum of 11 characters can be displayed on a single screen. Excess characters are scrolled on the display. When scrolling is complete, the first eleven characters are once more displayed on the screen. To re-scroll perform the following operation:

- 1 **Press the [DISP] button.**
Guidance information can be re-scrolled.

Changing AREA SHOT screens

1 Press the [RTN] button.

In the AREA SHOT mode, the audio screen can be accessed. Pressing the button repeatedly allows you to switch back and forth between the AREA SHOT screen and the Audio screen.



When a GPS unit is connected, the following operations are available.

- When your vehicle enters the display/map range of the guidance point, a blinking marker will appear to indicate the position of your vehicle.

Vehicle position marker

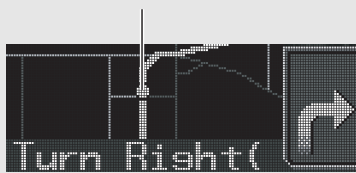









When vehicle position marker leaves the map range while traveling along the guidance route, the vehicle position marker disappears. Push [^] to display the next guidance point. In order to display vehicle position marker, your vehicle must be within the map display area.











- When vehicle enters the map range of a guidance point while the audio operation screen is displayed, [Map coverage area] will be appear on the display. Press [RTN] to return to the AREA SHOT screen. Pressing the audio operation button turns off [Map coverage area] message and allows operation of the audio system.

Display Arrows

Arrows for indicating turn directions are displayed as follows.

Straight ahead		Reverse direction	
Diagonally forward right		Diagonally left rear	
Right		Left	
Diagonally rear right		Diagonally forward left	

Depending on driving conditions, arrows indicate the following:

U-turn		Expressway		Intersection	
U-turn to the right		Traffic merges to the right		Right at the junction	
U-turn to the left		Traffic merges to the left		Left at the junction	
		Right hand entrance		Straight through the junction	
		Left hand entrance			
		A right hand exit			
		A left hand exit			

X

How to use the remote control

Precautions in use of the remote control

- Be careful when handling the remote control, especially because it is small and light. Dropping or striking it hard may damage it, wear out the battery or cause a malfunction.
- Keep the remote control free of moisture, dust and water. Do not subject it to shock.
- Do not place the remote control unit where it will get hot, such as on the dashboard or near a heater vent. Allowing the remote control unit to overheat may warp its case or cause other problems.
- Do not operate the remote control unit while driving because doing so could cause an accident.
- When using the remote control, point it toward at the remote control light receptor.
- The light receptor may not operate correctly if it is exposed to bright light such as direct sunlight.
- Be sure to press the [PWR] button on the main unit for more than two seconds to shut it down before leaving the car, or the car battery may be run down. When the main unit is shut down, the remote control will not work.
- Remove the batteries from the remote control unit whenever it is not to be used for a long time.

Cleaning the remote control

- Use a dry cloth to keep the unit clean. If the remote control unit gets extremely dirty, clean it with a cloth moistened with diluted liquid detergent. Do not use alcohol or thinner; these compounds may damage the finish.
- In no event should benzine or thinner be used. These substances will damage the case or finish.

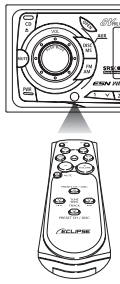

Remote-control
light receptor

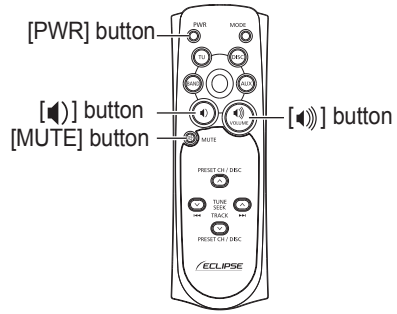

Turning the power on/off

When the power is turned on, the state used when the power was turned off such as CD and tuner playing is restored.

1 Press the [PWR] button.

The power turns on or off each time the button is pressed.



When the main unit is shut down, the remote control will not work.

Adjusting the audio volume

1 Press the [>] or [<] button.

[>] button: Increases the volume.

[<] button: Decreases the volume.

Muting the volume

Press the [MUTE] button for more than one second to cut the volume or restore it instantly.

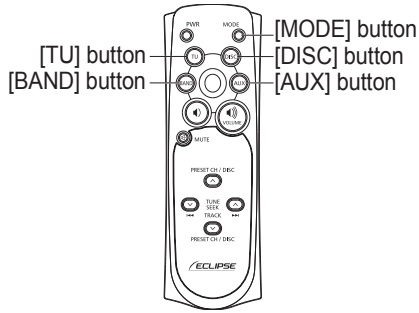

Switching playback modes

1 Press the [MODE] button.

Press the button to switch modes in the following sequence:

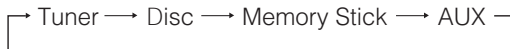

Modes can be switched by pressing the following buttons:

[TU] button: The tuner mode is activated.

[DISC] button: The disc mode is activated.

[AUX] button: The AUX mode is activated.

How to play the tuner

Select the tuner mode first

Selecting the FM/AM band

1 Press the [BAND] or [TU] button.

Each press will switch tuner modes from FM1 → FM2 → FM3 → AM.



- It is not possible to switch between FM/AM modes and SIRIUS with the remote control.
- If the optional SIRIUS tuner is connected, the selections will switch the mode from SR1 → SR2 → SR3 → SR4 in order.

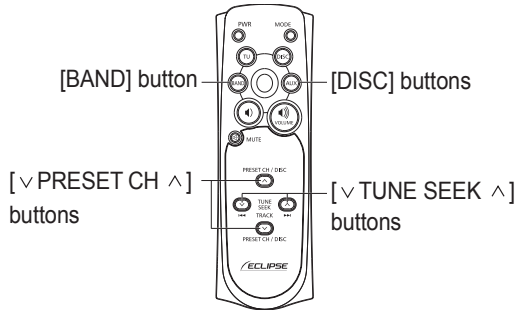

Selecting a station (manually or automatically)

A short press of the button will allow manual station tuning. Pressing for more than one second will start automatic tuning.

1 Press the [v TUNE•SEEK ^] button.

[^] button: Tunes to higher frequency stations.

[v] button: Tunes to lower frequency stations.

Selecting preset stations

A total of six stations may be selected (preset tuning) out of those already set in memory through the main unit. (Refer to "Manually setting stations into memory," page 108.)

1 Press the [v PRESET CH ^] button.

[^] button: Select the next higher number preset button.

[v] button: Select the next lower number preset button.

XI

How to play CDs

Switching disc modes

1 Press the [DISC] button.

The disc mode is activated.

2 Press the [DISC] or [BAND] button.

When one or two CD changers are connected, press the [DISC] or [BAND] button to change modes from CD player → CD changer 1 → CD changer 2.

The indicator will skip a changer or player that has no discs loaded.

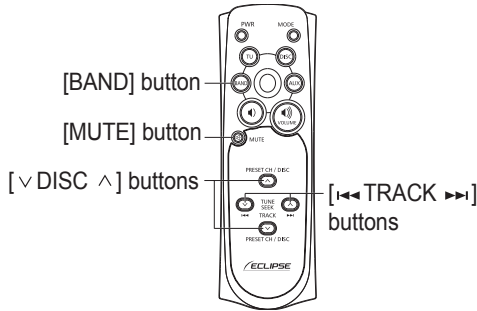

Advancing to the next track or returning to the beginning of the track being played

1 Press the [i<-< TRACK >> i] button.

[>>] button: Advances to the next track.

[i<-<] button: Returns to the beginning of the track being played.
(Press repeatedly to move to previous tracks.)



Hold the [>>] button down to fast forward, or the [i<-<] button to rewind through the track being played.

Skipping to the next or previous disc

1 Press the [v DISC ^] button.

[^] button: Selects the next higher number disc.

[v] button: Selects the next lower number disc.

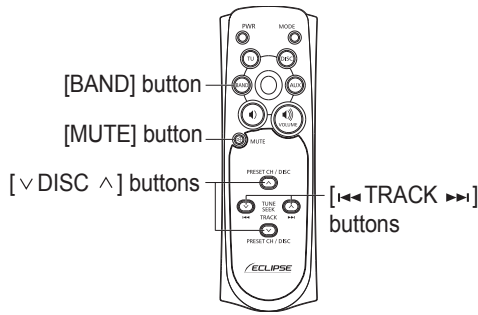

How to play MP3/WMA

Switching disc modes

1 Press the [DISC] button.

The disc mode is activated.

2 Press the [DISC] or [BAND] button.

When one or two CD changers are connected, press the [DISC] or [BAND] button to change modes from CD player → CD changer 1 → CD changer 2.

The indicator will skip a changer or player that has no discs loaded.



- The optional CD changer cannot be used to play MP3 files.
- If normally recorded music data (CDDA) and MP3 music files are mixed, the normally recorded music data will be played.

XI

Advancing to the next file or returning to the beginning of the file being played

1 Press the [i<< TRACK >>i] button.

[>>i] button: Advances to the next track (file).

[i<<] button: Returns to the beginning of the track (file) being played. (Press repeatedly to move to previous tracks (files).)



Hold the [>>i] button down to fast forward, or the [i<<] button to rewind through the track being played.

Skipping to the next or previous folder

1 Press the [v DISC ^] button.

[^] button: Selects the next folder.

[v] button: Selects the next lower folder.

Replacing the battery



To prevent accidents, store batteries out of the reach of children. If a child has swallowed one, consult a doctor immediately.

Use two AAA size batteries.

- 1** Remove the back cover of the remote control unit by gently pressing and sliding it in the direction indicated by the arrow.

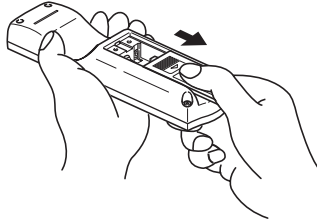

- 2** Install the two batteries provided into the compartment as illustrated inside the compartment.

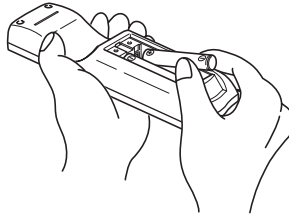

- 3** Return the back cover into place by sliding it in the direction indicated by the arrow.

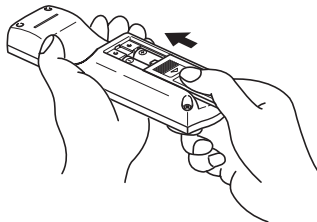



- Be extremely careful not to swallow the battery.
- The battery life is approximately one year. If the remote control unit does not operate correctly or if the button lamp gets dim, replace the batteries.
- Be sure to orient the batteries correctly so that the positive and negative poles match the diagram.
- Do not use one new battery and one old one; use two new batteries.
- Use only two of the same kind of battery.
- If any liquid is seen leaking from the batteries, remove both batteries and dispose of them properly. Thoroughly clean the battery compartment with a dry cloth. Then install new batteries.

How to operate the receiver with an optional CD changer connected

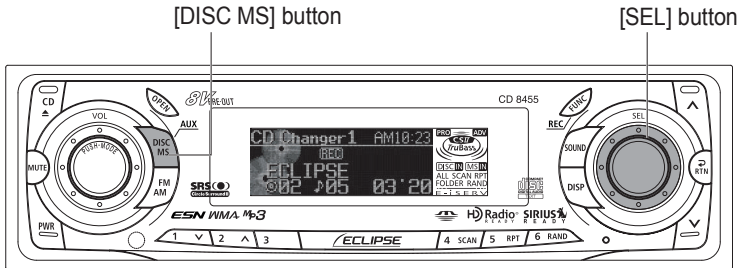

This section covers the operation of an optional CD changer that is connected to the receiver.

To switch from another mode, press the [DISC MS] button for less than one second.

Switching the input channel

Some connected CD changers will allow you to switch the input channel.

- 1 Press the [SEL] button for more than one second.

Each time the button is pressed, the input channel will switch between analog input and digital input.

Listening to a CD

- 1 Press the [DISC MS] button for less than one second.

Each press of the button switches the mode from CD player → CD Changer 1 → CD Changer 2 → Memory Stick player.

A changer or player with no discs loaded will be skipped.

Advancing to the next track or returning to the beginning of the track being played

- 1 Turn the [SEL] button to the left or right.

Turn to the right: Advances to the next track.

Turn to the left: Returns to the beginning of the track being played.

(Repeat turning for previous tracks.)

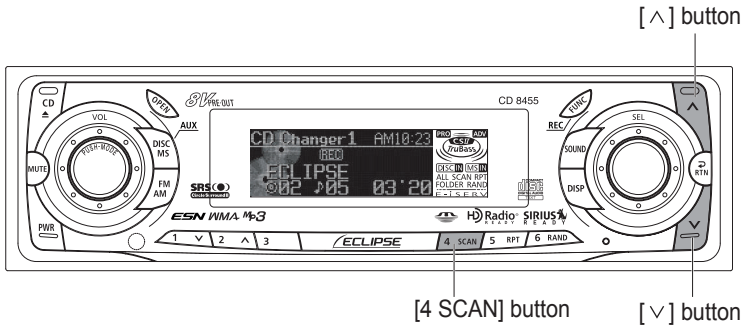

Fast Forward/Rewind

Fast forward or rewind the song currently being played.

1 Press and hold the [^] or [v] button.

[^] button: Fast forward.

[v] button: Rewind.

Playing the beginning of tracks (SCAN)

1 Press the [4 SCAN] button.

Pressing the button for less than one second causes the changer to move up to the next track and play it for 10 seconds, then move up to the next track and play it for 10 seconds, and so on, on one CD, until the button is pressed again.

Hold the button until the [ALL SCAN] display appears to play the first 10 seconds of the first track of every CD loaded.



ATTENTION

- To continue playing a desired track, press the button again to stop scanning.
- After the entire disc is scanned once, ordinary playback starts from the point where scanning started.

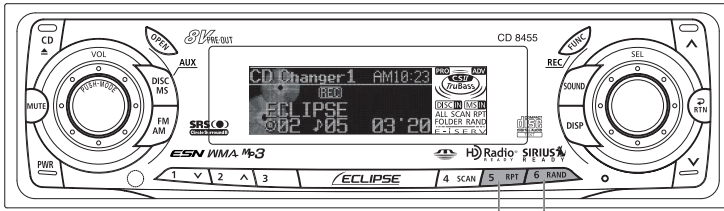

[5 RPT] button [6 RAND] button

Repeating the same track (REPEAT)

1 Press the [5 RPT] button.

Pressing on the button for less than one second causes the changer to repeat the track currently being played, until the button is pressed again.

Hold the button until the [ALL REPEAT] display appears to repeat all tracks on the CD being played.

Playing tracks in random order (RANDOM)

1 Press the [6 RAND] button.

Pressing on the button for less than one second causes the changer to play the tracks on the currently playing CD in random order, until the button is pressed again.

Hold the button until the [ALL RANDOM] display appears to play tracks from all of CDs loaded in the currently selected changer, in random order.



ATTENTION

- During random playback, press the [5 RPT] button to repeat the track being played. To cancel repeat play (go back to random play), press the [5 RPT] button again.
During playback of a particular track: The track being played is played repeatedly.
While searching: The following track is played repeatedly.
- Occasionally the same track happens to be played (selected) two or more times in a row, but it is not a sign of a problem.
- When any of the functions - "Playing the beginning of tracks," "Repeating the same track" and "Playing tracks in random order" - is selected, a message such as [SCAN], [ALL SCAN], [REPEAT], [ALL REPEAT], [RANDOM] or [ALL RANDOM] appears on the display to verify the current function.
- Random play is not canceled even if a magazine is ejected.

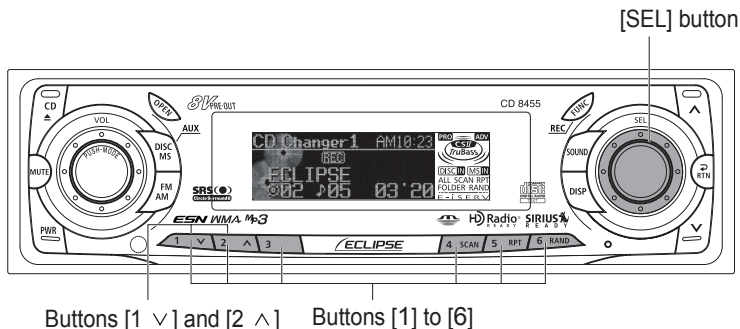

Skipping to the next or previous CD

1 Press button [1 ∨] or [2 ∧].

Button [1 ∨]: Selects the next lower number disc.

Button [2 ∧]: Selects the next higher number disc.

Specifying a CD to play

A CD of your choice is directly selectable out of the loaded discs.

1 Press the [SEL] button for less than one second.

2 Press a button from [1] to [6].

Buttons	1	2	3	4	5	6
CD	1	2	3	4	5	6
	7	8	9	10	11	12

To select a CD from nos. 7 to 12, press the desired button considerably longer.

How to operate the tuner with an optional HD Radio tuner connected (U.S.A. only)

About HD Radio

If the optional HD Radio (High Definition Radio) tuner unit is connected, terrestrial digital broadcasts can be received. When terrestrial digital broadcasts are received, FM reception has the same quality as a CD, and AM reception has the same quality as conventional FM sound. Depending on the reception status, HD Radio can also receive analog broadcasts, which means reception is still possible in regions with no digital coverage.

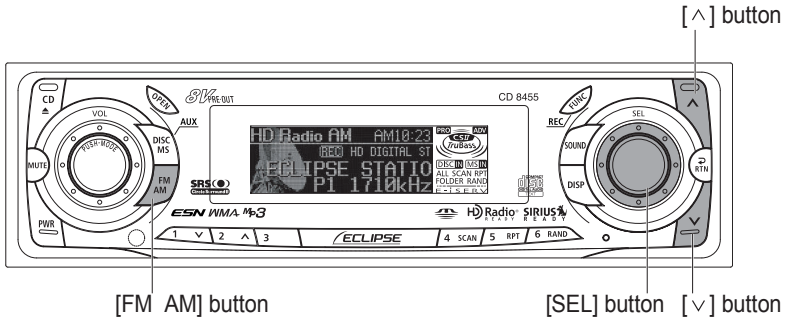

First, press the [FM AM] button to start tuner operation. There are automatic and manual methods for setting stations in memory. The receiver will accept up to 24 stations in memory: 6 in AM and 18 in FM (6 each for FM1, FM2 and FM3.) (Initial setting)

Tuning to a station

- 1 Press the [FM AM] button for less than one second to switch to the desired FM or AM bands.

Radio bands will switch from FM1 → FM2 → FM3 → AM in order each time the button is pressed.



ATTENTION

If the optional SIRIUS satellite radio tuner unit is connected, radio mode will be switched between the satellite radio mode and FM AM radio mode by pressing the [FM AM] button for more than one second.

- 2 Turn the [SEL] button to the left or right to tune to a station.

Turn to the right: Tunes to higher frequencies.

Turn to the left: Tunes to lower frequencies.

- 3 Press the [^] or [v] button to start the automatic station search.

[^] button: Starts searching toward higher frequencies.

[v] button: Starts searching toward lower frequencies.



ATTENTION

At times, it may be difficult to maintain optimum reception because the antenna affixed to your vehicle is in motion constantly (relative to the broadcast antenna), encountering continuous variation in the received radio signals' strength. Other factors affecting reception include interference from natural obstacles, sign posts, etc.

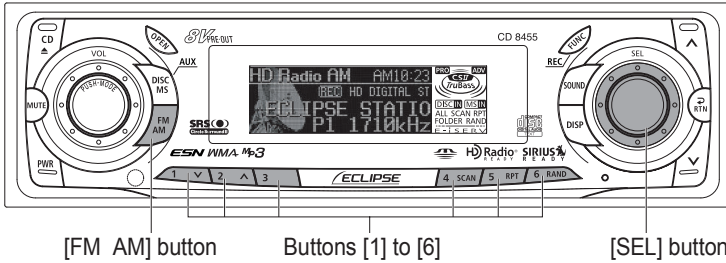

Entering stations into memory automatically (The automatic preset mode: ASM)

- 1 Press the [FM AM] button for less than one second to switch to the desired FM or AM bands.**

Radio bands will switch from FM1 → FM2 → FM3 → AM in order each time the button is pressed.



If the optional SIRIUS satellite radio tuner unit is connected, radio mode will be switched between the satellite radio mode and FM AM radio mode by pressing the [FM AM] button for more than one second.

- 2 Press the [SEL] button for more than two seconds until a beep is heard.**

The automatic preset mode starts.

The [ASM ON] indicator on the screen flashes, and stations are automatically entered in memory under buttons [1] to [6].

These buttons are called preset buttons.



- When a new station is set in memory, the station previously set in memory will be deleted.
- If there are fewer than six receivable stations, the stations set in the remaining buttons will be retained.

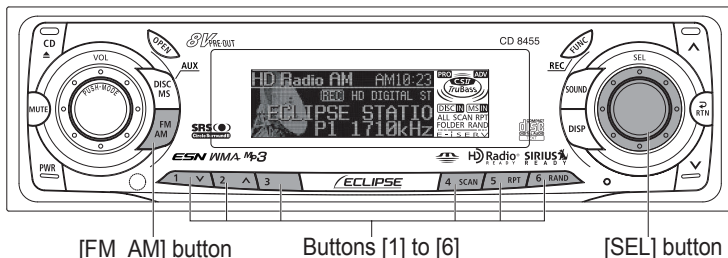

Manually setting stations into memory

This section covers the setting of stations in memory under the numbered buttons.

- 1 Press the [FM AM] button for less than one second to switch between FM and AM.**



If the optional SIRIUS satellite radio tuner unit is connected, radio mode will be switched between the satellite radio mode and FM AM radio mode by pressing the [FM AM] button for more than one second.

- 2 Turn the [SEL] button to the right or left to tune to the station to be entered in memory.**
- 3 Select any button, from [1] to [6], and press it for more than two seconds.**

The tuned station is now memorized and set in the button selected. Repeat the procedure to set additional manually tuned stations in memory, in turn, for buttons [1] to [6]. These buttons are called the preset buttons.



If the vehicle's battery is disconnected (for repairs to the vehicle or for removing the receiver), all stations in memory will be lost. In such a case, set stations in memory again.

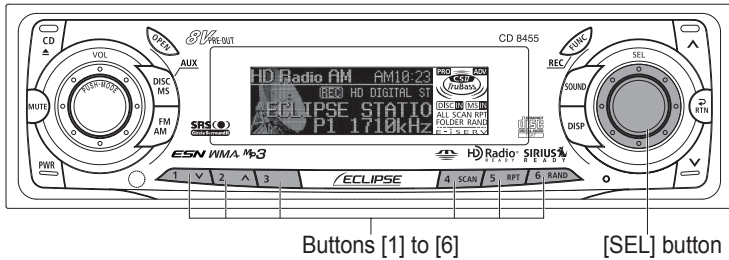

Preset station scan

This function enables reception of all the stations in the preset buttons for five seconds each.

- 1 Press the [SEL] button for less than two seconds.**
[P SCAN] will appear on the display, and stations stored under preset buttons [1] through [6] will be played for five seconds each.
- 2 To stop the preset scan mode at a desired station, press the [SEL] button again.**

The receiver will stay tuned to the desired station.

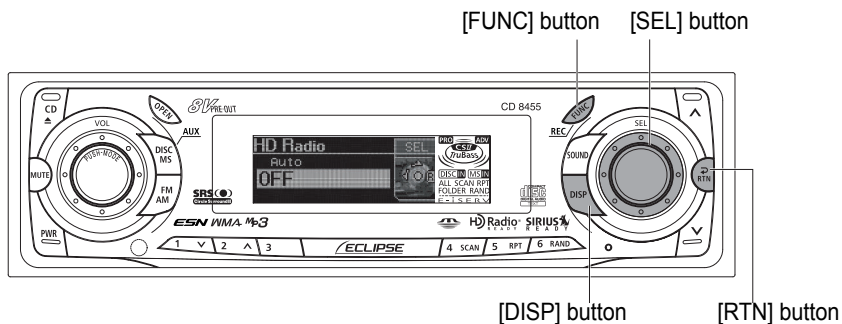

Switching between displays when receiving HD Radio

During digital reception, the name of the station being received and other information can be displayed.

1 Press the [DISP] button for more than one second.

Each time the button is pressed the display item changes in the following order:

station name → title* → artist* → album* → genre.

*: Depending on the nature of the broadcast, no information may be shown.



ATTENTION

The maximum number of characters that can be displayed for each item is as follows:

Long name: 48 characters

Short name: 7 characters

Song title: 32 characters

Album: 32 characters

Genre: 32 characters

XIII

HD Radio reception settings

The HD Radio reception method can be selected. When the HD Radio tuner is connected to this deck for the first time, it will be set at [AUTO] (automatic digital/analog selection).

1 Press the [FUNC] button for less than one second.

The function mode is activated.

2 Turn the [SEL] button to select HD Radio.

The selected item will be high lighted.

3 Press the [SEL] button.

The mode will change to reception setting mode.

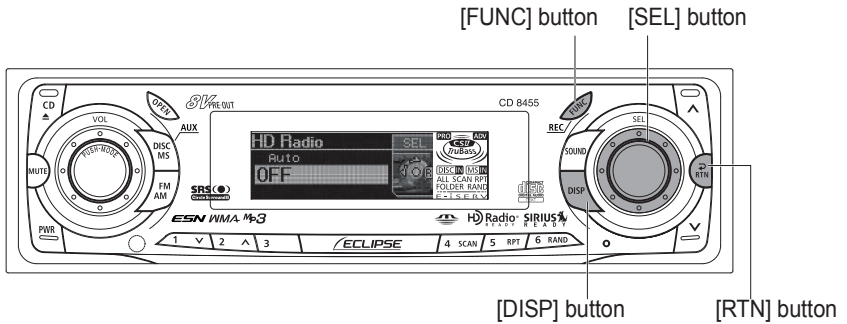

4 Turn the [SEL] button to select AUTO or OFF.

The selected item will be highlighted.

In the [AUTO] setting, the selection is switched between digital and analog reception automatically. In areas where digital reception is not possible, reception is automatically switched to analog to avoid loss of reception. During digital reception, [DIGITAL] is shown on the display. This is cleared during analog reception.

In the [OFF] setting, reception is always analog.

5 Press the [SEL] button.

6 Press the [RTN] button.

At this time, other adjustments can also be made in function mode.

7 Press the [FUNC] or [RTN] button to exit function mode.

How to operate the tuner with an optional SIRIUS satellite radio tuner connected (U.S.A. only)

About SIRIUS satellite radio

If the optional SIRIUS satellite radio tuner unit is connected, satellite radio broadcast can be received.

With SIRIUS satellite radio, over 100 channels are available including music, sports, news, and entertainment programs.

The channel can be selected from categories such as POP and ROCK, or by selecting individual channel manually.

Reception of SIRIUS satellite radio is fee based; you have to subscribe to it.

It is possible to subscribe through the SIRIUS radio website.

URL: <http://cdn.sirius.com>



For information about the operation and set-up of the SIRIUS satellite radio tuner unit, see the SIRIUS satellite radio unit's owner's manual.

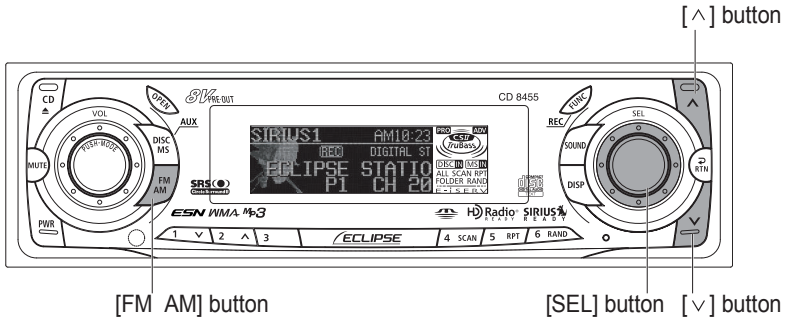

The receiver will accept up to 24 stations in memory.

Selecting the radio mode

- 1 Press the [FM AM] button for more than one second.

The mode switches between satellite radio mode and FM/AM radio mode each time the button is pressed.

Selecting a channel

- 1 Press the [FM AM] button for less than one second to switch to the desired SR bands.

Radio bands will switch from SR1 → SR2 → SR3 → SR4 in order each time the button is pressed.

- 2 Turn the [SEL] button to the left or right to tune to a channel.

Turn to the right: Selects the higher channel.

Turn to the left: Selects the lower channel.

- 3 Press the [^] or [v] button for less than one second to start the automatic channel search.

Reception is enabled for all channels within the currently selected category.

(Refer to page 205 for details on "Category selection".)

[^] button: Starts searching toward higher channels.

[v] button: Starts searching toward lower channels.

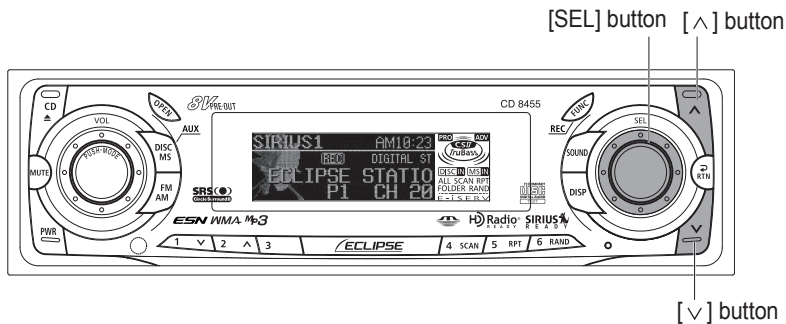

Category selection

The channel can be selected from among categories such as POP and ROCK.

Consult the SIRIUS website for details of categories.

1 Press the [^] or [v] button for more than one second.

Categories will switch in order shown below each time button is pressed.

[^] button Advance to next category.

[v] button Return to previous category.

Direct Channel selection

The channel can be selected by inputting the channel directly.

1 Press and hold the [SEL] button for more than two seconds.

The mode will change to direct channel selection mode.

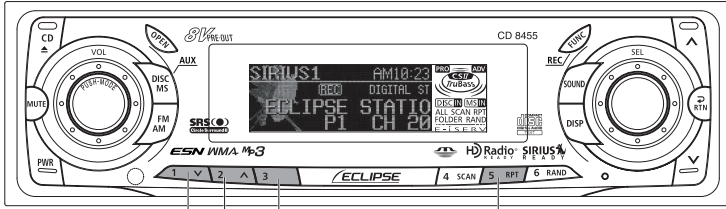

Buttons [1] to [3]

Button [5]

2 Press the buttons [1], [2] and [3] to select the channel number to be input.

- [1] button Hundreds
- [2] button Tens
- [3] button Units

Each time the buttons are pressed, the numerals change in the following order.

0 → 1 → 2 → 3 → 4 → 5 → 6 → 7 → 8 → 9

Pressing the [6] button clears the numeral at the previous digit.

3 Press the button [5].

Starts reception.

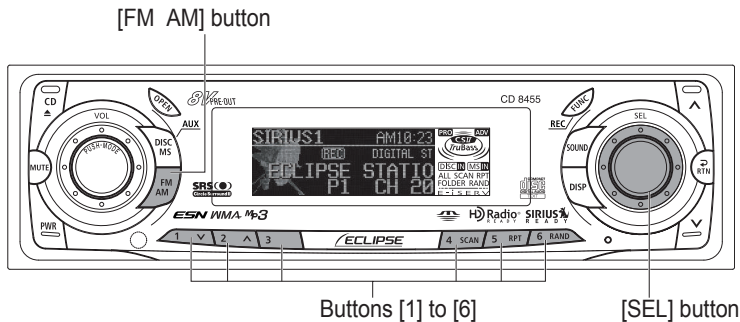

Manually setting channels into memory

This section covers the setting of channels in memory under the numbered buttons.

- 1** Turn the [SEL] button to the right or left to tune to the channel to be entered in memory.
- 2** Select any button, from [1] to [6], and press it for more than two seconds.

The tuned channel is now memorized and set in the button selected. Repeat the procedure to set additional manually tuned channels in memory, in turn, for buttons [1] to [6]. These buttons are called the preset buttons.



Caution

If the vehicle's battery is disconnected (for repairs to the vehicle or for removing the receiver), all channels in memory will be lost. In such a case, set channels in memory again.

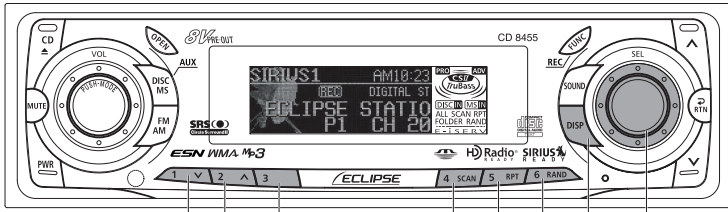

Buttons [1] to [6] [DISP] button [SEL] button

Preset channel scan

This function enables reception of all the channels in the preset buttons for five seconds each.

1 Press the [SEL] button for less than two seconds.

[P SCAN] will appear at the display, and channels stored under preset buttons [1] through [6] will be played for five seconds each.

2 To stop the preset scan mode at a desired channel, press the [SEL] button again.

The receiver will stay tuned to the desired channel.

Switching displays when using the SIRIUS satellite radio

1 Press the [DISP] button for more than one second.

Each time the button is pressed the display item changes in the following order:

channel name → category name → title → artist → SIRIUS unit ID.



ATTENTION

- The maximum number of characters that can be displayed for each item is as follows:
 - Title: 38 characters
 - Artist: 38 characters
 - Channel: 20 characters
 - Category: 16 characters
- If there is no name, NO_ DATA will appear.

Others

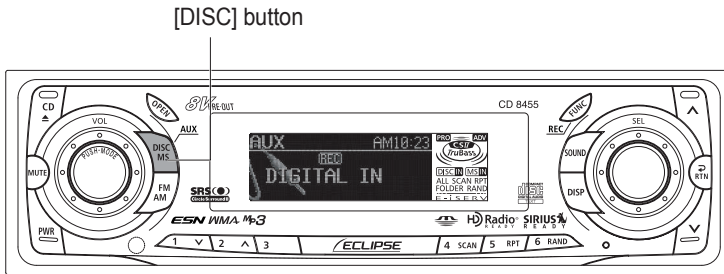

Connecting portable audio players to the AUX jack

Use a commonly available accessory cord with the RCA connector to connect a portable audio player to the AUX (auxiliary) jack of this system. The deck is compatible with portable audio players with both analog output and digital output (44.1 kHz and 48 kHz).

- 1 Turn on the portable audio player and start its play function.**
- 2 Switch to AUX mode by pressing the [DISC] button for more than one second.**

Activation of the AUX mode will light the "AUX" indicator and channel audio player output to the system speakers.



- While the AUX mode is activated, actions such as turning off the audio player or pulling out the connection cord may cause noise spikes that can damage the system speakers. Be sure to avoid this possibility by turning off system power or switching from AUX mode to another mode before shutting off or disconnecting the portable audio player.
- Audio output levels will differ for the various devices that can be connected by this method. Carefully adjust volume until the output level of the connected player is known.
- Before using a portable audio player in a vehicle, read the player's operation manual carefully and confirm problem-free operation in the vehicle before proceeding.

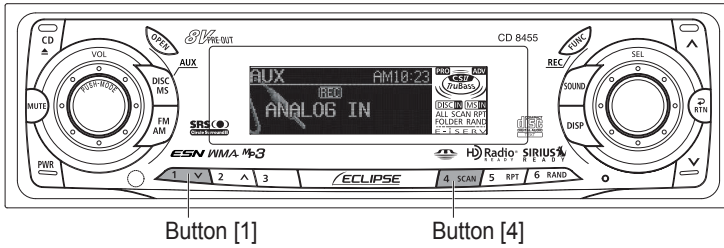

Switching the external input method (analog/digital)

You can switch the external input method for the deck. Select the method that matches the output method for the portable audio player that is connected to the deck.

1 In AUX mode, press button [1] or button [4].

Button [1]: Switches to digital input.

Button [4]: Switches to analog input.

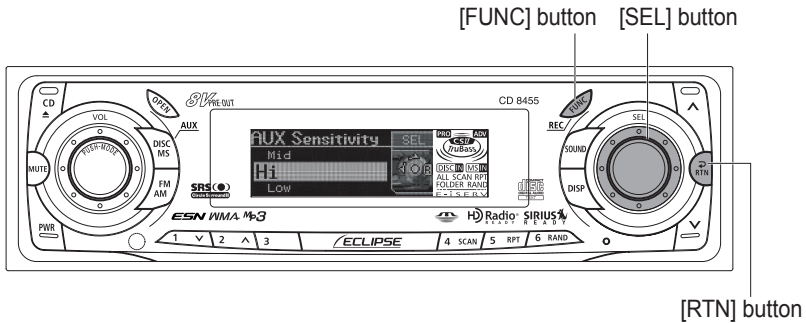

Changing auxiliary input sensitivity

The sensitivity of the auxiliary mode can be changed.

- 1 Press the [FUNC] button for less than one second.**
The function mode is activated.
- 2 Turn the [SEL] button to select AUX Sensitivity.**
The selected item is highlighted.
- 3 Press the [SEL] button.**
The AUX sensitivity mode is activated.
- 4 Turn the [SEL] button to select the sensitivity mode.**
Turning the button allows you to toggle through sensitivity modes as follows:

Low → Mid-Low → Mid → Hi



ATTENTION

Input sensitivity modes are roughly as follows:

Low	2 Vrms
Mid-Low	960 mVrms
Mid	480 mVrms
Hi	240 mVrms

- 5 Press the [SEL] button.**
The selected settings will take effect.
- 6 Press the [RTN] button.**
At this time, other adjustments can also be made in function mode.
- 7 Press the [FUNC] or [RTN] button to exit function mode.**

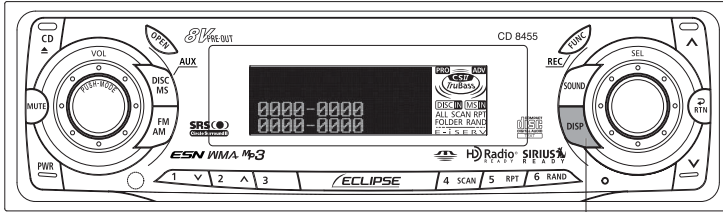

[DISP] button

User Registration Key display

User Registration Key is your CD8455's unique ID. In order to use the ECLIPSE website (E-iSERV), a 16-digit User Registration Key is necessary.

- 1 Check that the deck is in standby mode.**
- 2 Press the [DISP] button for more than one second.**

The first 8 digits of your User Registration Key will be displayed. Press and hold [DISP] once more (for a second or more) and the remaining 8 digits will be displayed.



Your User Registration Key is a 16-digit ID composed of numbers 0-9 and letters A-F.

If you have a question:

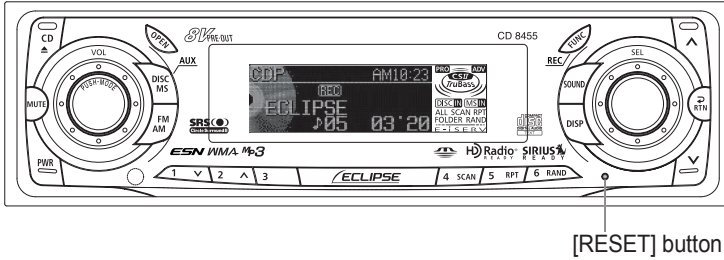

First check the item mentioned below before attempting to troubleshoot problems.



Caution

If a problem occurs, for instance when the unit does not respond to any button presses, or the display doesn't work correctly, press the [RESET] button using a paper clip or similar item. Pressing the [RESET] button will delete all the entries from memory. The settings will return to those made at the factory prior to shipment.

Displayed information (for troubleshooting)

The information listed in the chart below is displayed to show the status of the CD, Memory Stick player, Area Shot function, Sirius Radio and CD changer. Refer to the chart for the appropriate action.

Information Contents		Explanation and remedial action to take
INFO 2	NO DISC LOADED IN THE MAGAZINE	There is no disc in the magazine or player. Load a disc in the magazine. (Load a music disc.)
INFO 3	DISCS ARE DIRTY OR DAMAGED	The loaded disc is dirty or upside down. Check it for proper orientation and verify it is clean.
INFO 5	CD PLAYER AND CD CHANGER FAILS MECHANICALLY	<ul style="list-style-type: none"> The CD player and CD changer is inoperative for some reason. Go through the magazine removal procedure. If a magazine fails to eject, have your dealer fix problem.
INFO 6	WHEN THE CD PLAYER AND CD CHANGER INTERNAL TEMPERATURE IS HIGH (TO PROTECT PICKUP UNIT)	<ul style="list-style-type: none"> The temperature in the CD player and CD changer is too high for operation. Wait till it cools down. Resume playing after the "High temperature sensed and CD stopped" display disappears. If the CD still cannot play, have your dealer repair it.
INFO 7	AN INTERNAL POWER SUPPLY FAILURE IS OCCURRING	<ul style="list-style-type: none"> Turn the ACC off once before turning it on once again to resume the operation. If this condition persists, please contact your dealer.
LOAD		CD changer is in the process of verifying the presence of CDs after a magazine has been inserted into the CD changer.
MSINFO 1	YOU TRIED TO PLAYBACK, RECORDING AND READING DATA WHEN NO MG MEMORY STICK OR MEMORY STICK WAS INSERTED	Insert MG Memory Stick or Memory Stick.
MSINFO 2	YOU TRIED TO PLAYBACK AN INCORRECTLY FORMATTED MEMORY STICK	Use the deck to format the Memory Stick.
MSINFO 3	THE WRITE PROTECTION SWITCH IS LOCKED.	Unlock the write protection switch.
MSINFO 4	THE MEMORY STICK FULL	Delete some of the data from the Memory Stick before saving.

MSINFO 5	YOU TRIED TO RECORD MORE THAN THE MAXIMUM NUMBER OF TRACKS (400) ONTO A MG MEMORY STICK	Delete some of the MG Memory Stick data or use a different MG Memory Stick for recording.
MSINFO 6	AN INCOMPATIBLE MEMORY STICK HAS BEEN INSERTED	Check that the Memory Stick can be used with this deck.
MSINFO 7	MG MEMORY STICK CONTAINING NO MUSIC DATA HAS BEEN INSERTED	Insert a MG Memory Stick containing music data.
MSINFO 8	YOU TRIED TO PLAYBACK DATA THAT INCLUDES A PLAYBACK GUARD	Data that includes a playback guard can not be played back.
MSINFO 9	MG MEMORY STICK YOU TRIED TO PLAY BACK HAS PLAYBACK LIMITATIONS	Data that includes a playback guard can not be played back.
FILE ERR	A MG MEMORY STICK CONTAINING INCOMPATIBLE FILES HAS BEEN INSERTED	Insert a MG Memory Stick containing compatible files.
REC ERR	YOU TRIED TO RECORD MUSIC FROM AN AUDIO CD SUCH AS A CD-R OR CD-RW TO THE MG MEMORY STICK	This deck is compatible with SCMS/SDMI standards, and so it can not record music from audio CDs such as CD-Rs and CD-RWs.
LOAD_MAP_DATA	DAMAGE TO MEMORY STICK DATA	Memory stick data is damaged because the ignition switch has been turned ON/OFF during the data import process.
AUTH_ERR	AREA SHOT DATA CANNOT BE IMPORTED PROPERLY	Confirm the Memory Stick data.
SIZE_ERR	THE VOLUME OF IMPORT DATA IS LARGE	Confirm the Memory Stick data.
ANTENNA	Sirius ANTENNA IS DISCONNECTED	Connect the Sirius antenna.
CALL 888-539-SIRIUS	NO SUBSCRIPTION TO THE SELECTED CHANNEL	Subscribe to Sirius to receive the service by Sirius Satellite radio.
ACQUIRING	Sirius Satellite RADIO SIGNAL RECEIVING FAILS	Select another channel.

Mode	Problem	Causes	Remedial action to take	Refer to page
Common to all	Dead or weak sound	Is the volume control up sufficiently?	Turn up the volume control.	45
		Is the muting function in effect (MUTE)?	Cancel the muting (MUTE) function.	45
		Is the fader or balance control set far to one side?	Readjust the fader and balance controls to more normal positions.	47
		Other probable causes include broken audio-signal wiring or a faulty speaker.	Have your dealer check the problem.	—
	Power does not turn on.	Are there too electrical items installed, causing a lack of power?	Have your dealer check the problem.	—
		Other probable causes include a run-down car battery, broken power or interconnection wiring.	Have your dealer check the problem.	—
	Frequencies or titles set in memory are deleted.	Has the car battery been disconnected for repair or checked out?	Reenter them into memory.	107, 108
		Are there too electrical items installed and causing lack of available power?	Have your dealer check the problem.	—
		Other probable causes include run-down car battery, broken power or interconnection wiring.	Have your dealer check the problem.	—
	No guide tone sounds.	Is the guide tone disabled?	Enable the guide tone.	61
	The remote control does not work.	Is the battery low?	Replace battery.	190
		Is the battery installed in reverse polarity?	Reinstall the battery in the correct polarity.	190
		Is direct sunlight hitting the remote control light receptor?	Use the remote control close to the receptor.	—
		Other probable causes include a malfunctioning remote control.	Have your dealer check the problem.	—

Mode	Problem	Causes	Remedial action to take	Refer to page
CD	The disc cannot be inserted. The disc is ejected as soon as it is inserted. Or, the disc cannot be ejected. The disc cannot be changed.	Is an extra label or seal applied to the disc?	Do not apply labels or seals to the disc.	17
		Are there rough edges, deformations or damaged areas on the disc?	Try inserting another disc. Remove any burrs. Do not use a deformed or damaged disc.	18
	Sound skips around. Sound is intermittent. Sound is bad in quality.	Is the disc damaged? (scratched, warped, etc.)	Try another disc. Do not play a damaged disc.	17
		Is the disc clean?	Clean the disc.	19
		Is the player mounted at a proper angle? Is the player mounted loosely?	Have your dealer check it out.	—
		Are you driving over a rough surface?	Avoid playback while driving over rough surfaces.	16
	The disc cannot be ejected.	If unknown	Press the [DISC] button a bit longer and then press the [OPEN] button (forced Eject).	—

Mode	Problem	Causes	Remedial action to take	Refer to page
Tuner	Receives no stations, or receives static noise.	Is the antenna retracted?	Extend the antenna.	—
		Is the tuner correctly tuned to a station?	Tune to a station.	106
		Are you driving outside the service area of your preset stations?	Tune to a local station. (Please note, there may be no local stations servicing the area where you are currently driving.)	106
		Are you operating other equipment such as computer, or a mobile phone, in your vehicle at the same time as your receiver?	Avoid operating such equipment while using the receiver.	—
		Other problems may include a loose or disconnected antenna cable, a bad antenna cable or a bad	Have your authorized Eclipse retailer check the problem.	—

Specifications

<GENERAL>

Power Supply	14.4V DC (11-16V)
Current Drain	3A
Dimensions (W x H x D)	
In-Dash Unit	7" x 2" x 6-1/8" (178 x 50 x 155mm)
Mass (weight)	Approx. 1.7kg
Usage temperature range	-20°C to +65°C (-4°F to +149°F)
Storage temperature range	-40°C to +85°C (-20°F to +185°F)

<FM TUNER>

Frequency Range	
USA:	87.75~107.9MHz (0.2MHz step)
Asia:	87.5~108MHz (0.05MHz step)
Australia:	87.5~108MHz (0.1MHz step)
Latin America:	87.75~107.9MHz (0.1MHz step)
Usable Sensitivity	13dBf
50dB Quieting Sensitivity	14dBf
Frequency Response	30~15,000Hz, ±3dB
Stereo Separation	38dB (1kHz)

<AM TUNER>

Frequency Range	
USA:	530~1,710kHz (10kHz step)
Asia:	522~1,629kHz (9kHz step)
Australia:	522~1,710kHz (9kHz step)
Latin America:	530~1,710kHz (10kHz step)
Usable Sensitivity	20μV

<CD SECTION>

Frequency Response	20Hz~20kHz, ±3dB
Wow & Flutter	Below measurable limits
Stereo Separation	85dB
S/N Ratio (A-weighted)	100dB
Dynamic Range	98dB
Total Harmonic Distortion	0.008%

<MEMORY STICK SECTION>

Frequency Response	20Hz~20kHz \pm 3dB
S/N Ratio (A-weighted)	100dB
Total Harmonic Distortion	0.008 %

<AUDIO AMPLIFIER>

Power Output	14W x 4 (20Hz~20kHz, 1% THD, 4 Ω , Vcc=14.4V) Max. 50W x 4
Output Level/Impedance	8V/55 Ω line-out impedance
Tone Control	
Bass:	\pm 12dB at 80Hz
Middle:	\pm 12dB at 630Hz
Treble:	\pm 12dB at 10kHz
Loudness	+10dB at 100Hz/+6.5dB at 10kHz

Before installation

● Note ●

Be sure to disconnect the vehicle battery's negative terminal before installing the receiver.

Components

No.	Item	Qty
1	Main unit	1
2	Mounting sleeve	1
3	Side bracket	2
4	Rear bracket	1
5	Bezel	1
6	Bushing	1
7	Self-tapping screw (6 x 16 mm)	1
8	Stud bolt	1
9	Flat head screw (red: 5 x 8 mm)	4
10	Hex-head bolt (red: 5 x 8 mm)	4
11	Hex-head bolt (6 x 20 mm)	1
12	Hex nut (5 mm)	1
13	Hex nut (6 mm)	1
14	Interconnecting cable	1
15	Remote control	1
16	Memory Stick	1
17	Microphone for measuring frequency characteristics	1

Installation angle

In order to maintain proper functioning, install the unit within an angle of 30 degrees from horizontal (standard). If this is not done, sound skipping or ejection of the CD may occur.

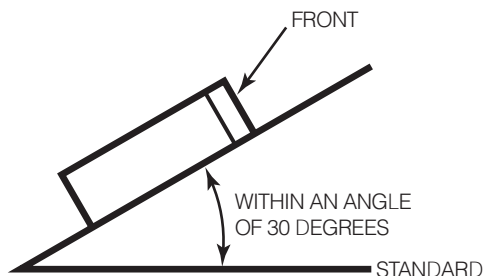

Mounting instruction

Mounting the main unit

–If installing the main unit by the mounting sleeve–

- 1** Insert the mounting sleeve into the opening in the vehicle dash board or console box.
- 2** Use a screwdriver or the like to bend the tabs in the mounting sleeve to secure the mounting sleeve.

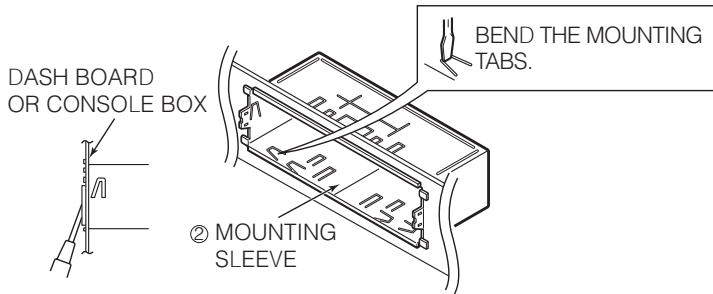

- 3** Attach the side brackets to the main unit using flathead screws.

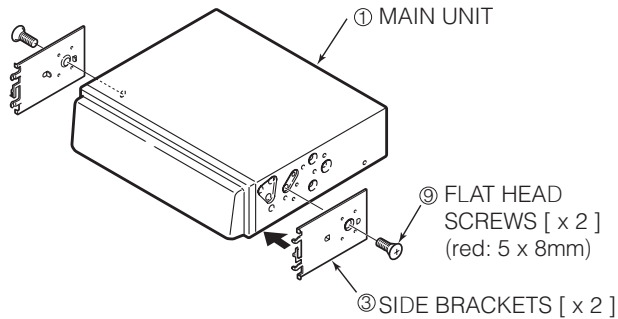

- 4** Mount the stud bolt to the main unit.
- 5** Insert the main unit into the mounting sleeve until it locks in place.
- 6** Fasten the rear of the main unit using either method [A] or [B].

Some automobiles may be equipped to secure the back of the main unit using the stud bolt and supplied rubber support. Select method [A] or [B] to suit the interior configuration of the vehicle.

7 Install the bezel on the main unit.

[A]

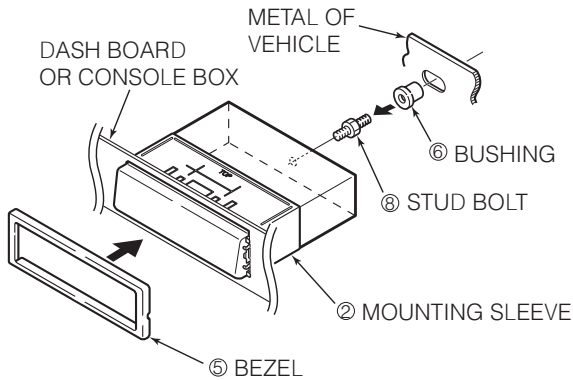

[B]

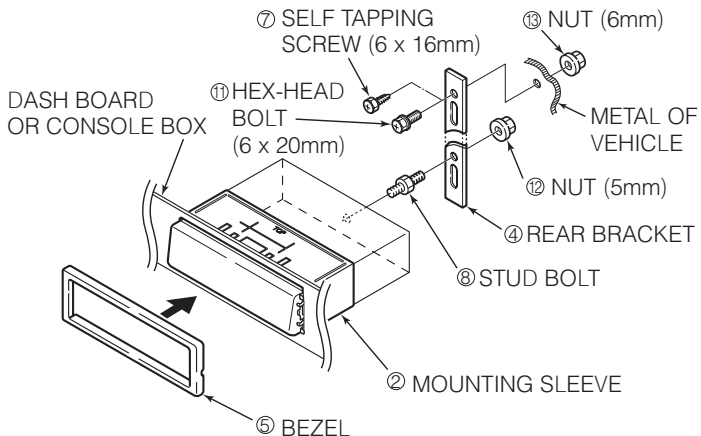

–If installing the main unit by the side brackets of the vehicle–

- 1** Remove the pockets and any other accessories from the center cluster to make room for the main unit.
- 2** Remove the mounting side brackets for the pocket.

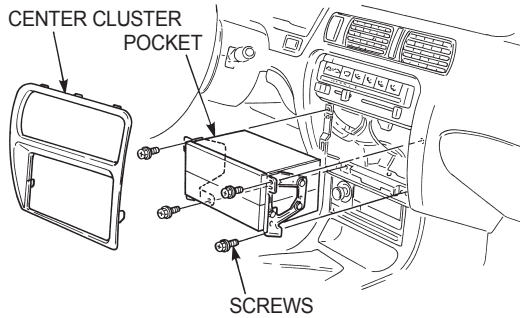

- 3** Attach the side brackets to the main unit.
- 4** Install the main unit in the vehicle.

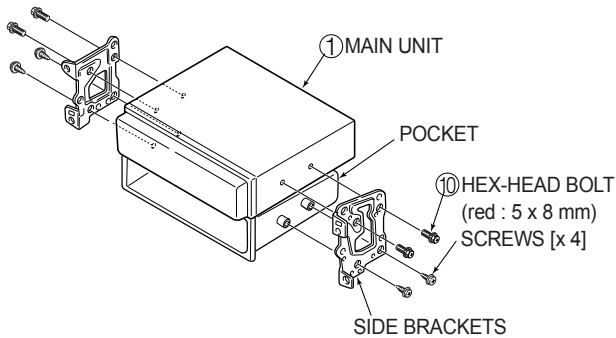

Names of lead wires and destinations (refer to Page 227)

● **Caution** ●

Never connect the power supply to the speaker leads, otherwise it causes damage to the main unit.

● **Note** ●

To prevent unconnected leads from shorting out, insulate them by wrapping their tips with electrical tape. Similarly, insulate the ends of connected leads.

If an external amplifier is to be connected to the receiver, be sure to ground its outside housing to the vehicle body (a metal part).

No.	Name	Wire color	Destination
1	ACC	Red	Connect where the power comes on when the ignition is in the ACC position.
2	B+	Yellow	Connect where the power is constantly available, regardless of the ignition switch's position.
3	Ground	Black	Connect where good body grounding is available.
4	Antenna power supply	Blue	Connect to the automatic-antenna control terminal of the vehicle.
5	Illumination power supply	Orange/white	Connect to where power comes on when the headlights are turned on.
6	Control power supply	Blue/white	Connect to the control terminal for the external amplifier, etc.
7	E-LAN terminal		Connect to the E-LAN terminal of the CD changer, etc.
8	Line-out terminals (Front/Hi)		Connect to the RCA input connectors of an external amplifier.
9	Line-out terminals (Rear/Mid)		
10	Line-out terminals (Nonfader/Low)		Connect to the RCA input connectors of a EQ, or the RCA input connectors of a woofer amplifier.
11	Speaker leads		Connect them to their respective leads.

No.	Name	Wire color	Destination
12	AUX in terminals		Connect to an external voice output terminal. If the microphone for measuring frequency characteristics is used, connect microphone to the L side of the RCA terminal.
13	Digital in terminal		Connect to digital output terminal of the CD changer.
14	LAN terminal		Connect to the LAN terminal of the GPS unit.
15	Genuine steering remote control terminal		Connect to the vehicle steering remote control. * Compatible vehicle models for installation : Vehicle with voltage detection-type steering remote control. Ask your dealer for details.

Measuring the frequency characteristics inside the passenger compartment

- 1** Connect the microphone for measuring frequency characteristics to the microphone terminal of the tuner-amplifier.
- 2** Install the microphone to the headrest of the driver's seat.

● Note ●

Using the supplied velcro strap, secure the microphone to the base of the headrest.

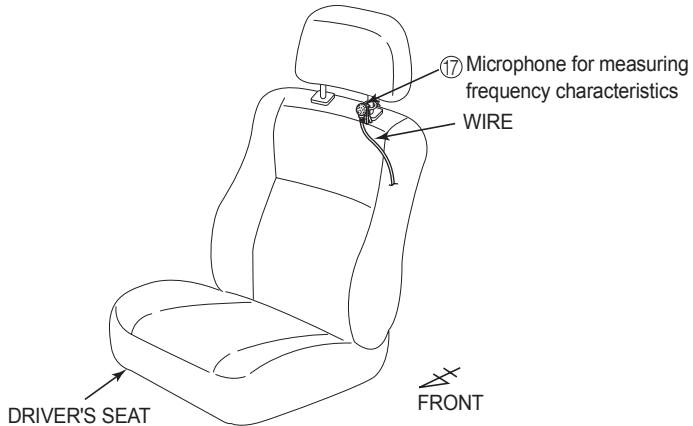

System

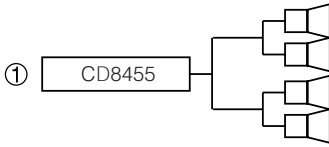

Note:

Adjust the external amplifier's input level.

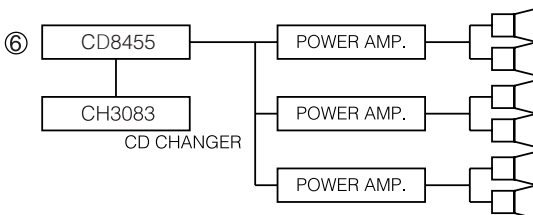
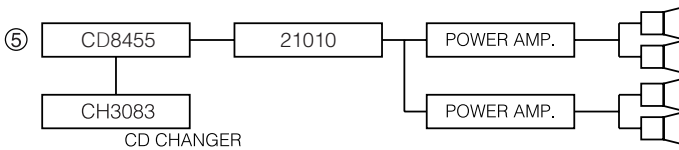
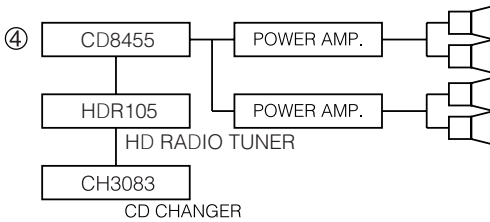
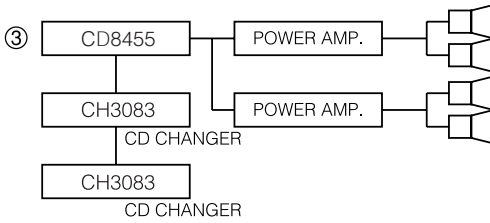
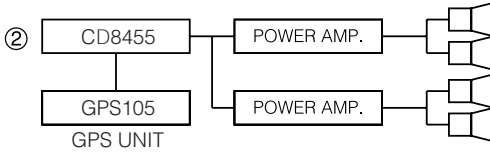

1) CD8455 Receiver, used alone

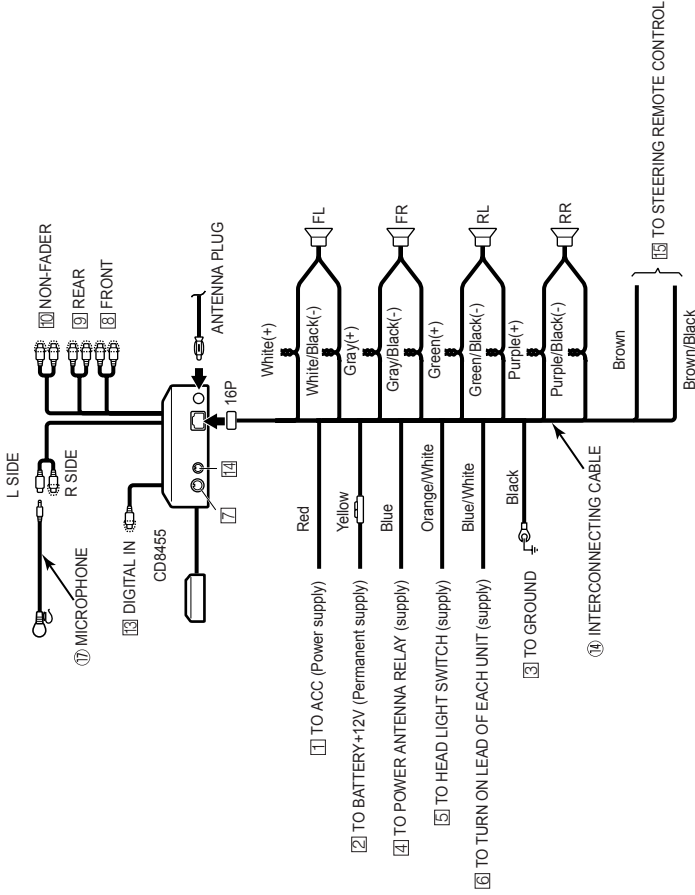

Caution

Never connect the power supply to the speaker leads, otherwise it causes damage to the main unit.

2) CD8455 + GPS105

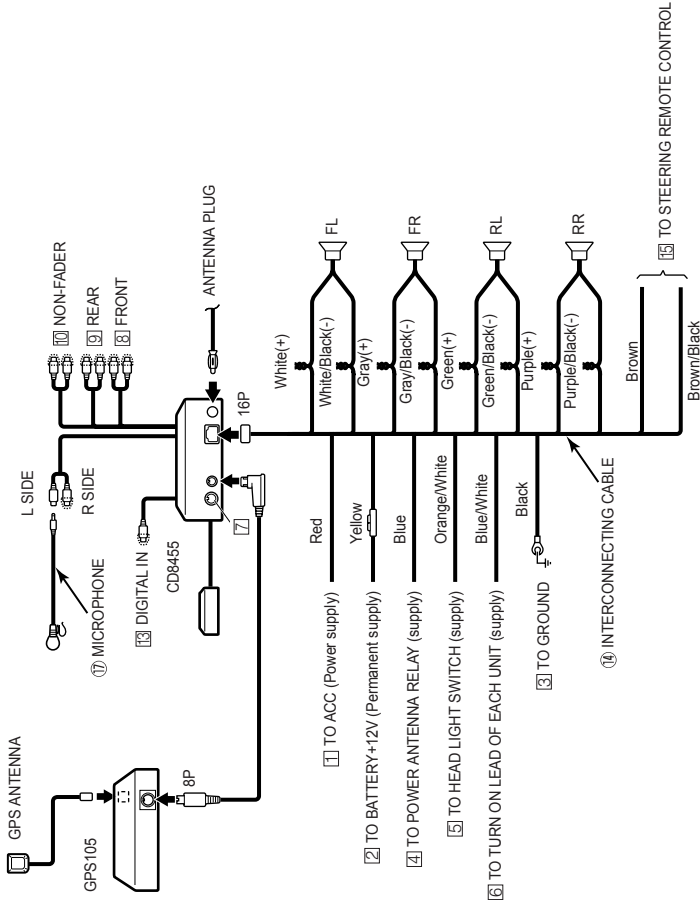

Caution

Never connect the power supply to the speaker leads, otherwise it causes damage to the main unit.

3) CD8455 + CH3083 + CH3083 + Power Amplifier

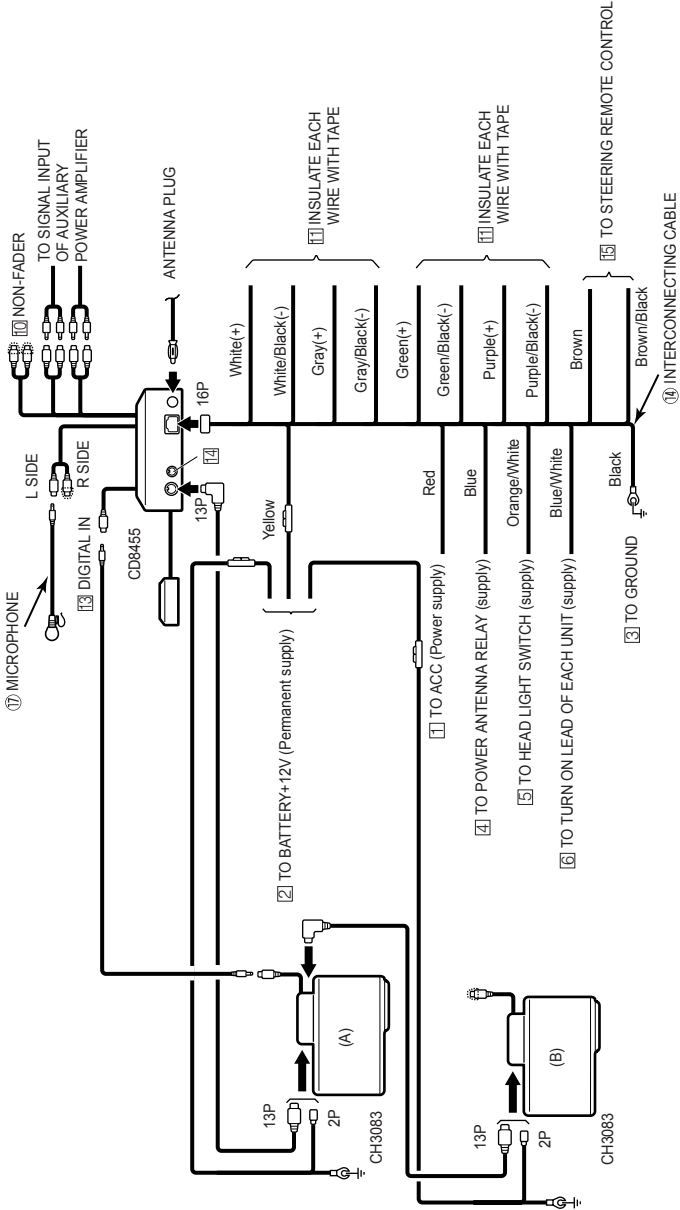

Caution

Never connect the power supply to the speaker leads, otherwise it causes damage to the main unit.

Note

1. The switch on the back side of CD changer (A) must be set the "L" position.
2. The switch on the back side of CD changer (B) must be set the "H" position.
3. CD changer (B) uses analog output.

4) CD8455+HDR105+CH3083+Power Amplifier

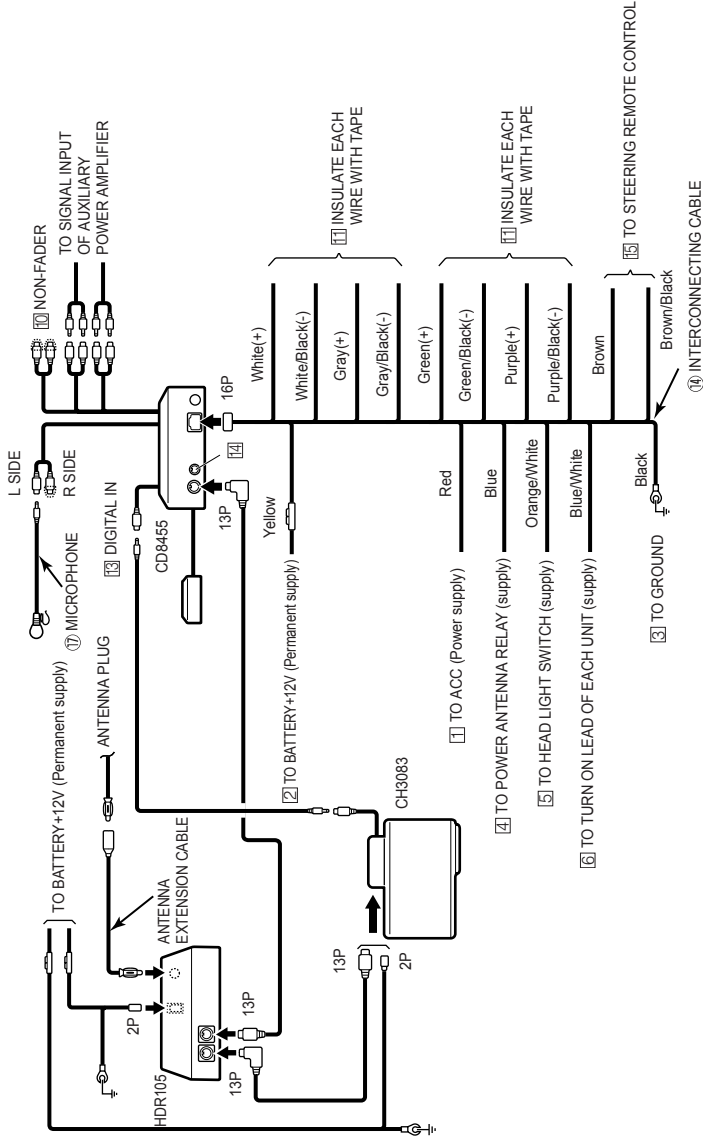

Caution

Never connect power supply to the speaker leads, otherwise it causes damage to the main unit.

5) CD8455 + CH3083 + 21010 + Power Amplifier

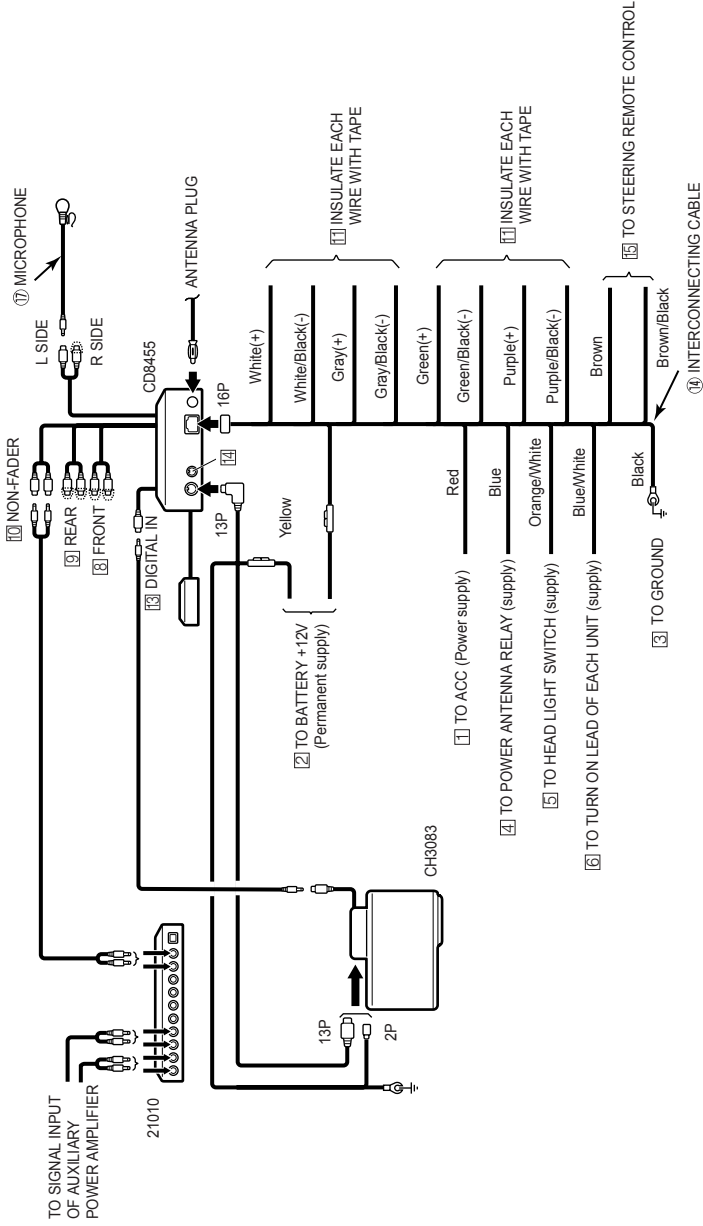

Caution

Never connect the power supply to the speaker leads, otherwise it causes damage to the main unit.

6) CD8455 + CH3083 + Power Amplifier (for Pro-Mode)

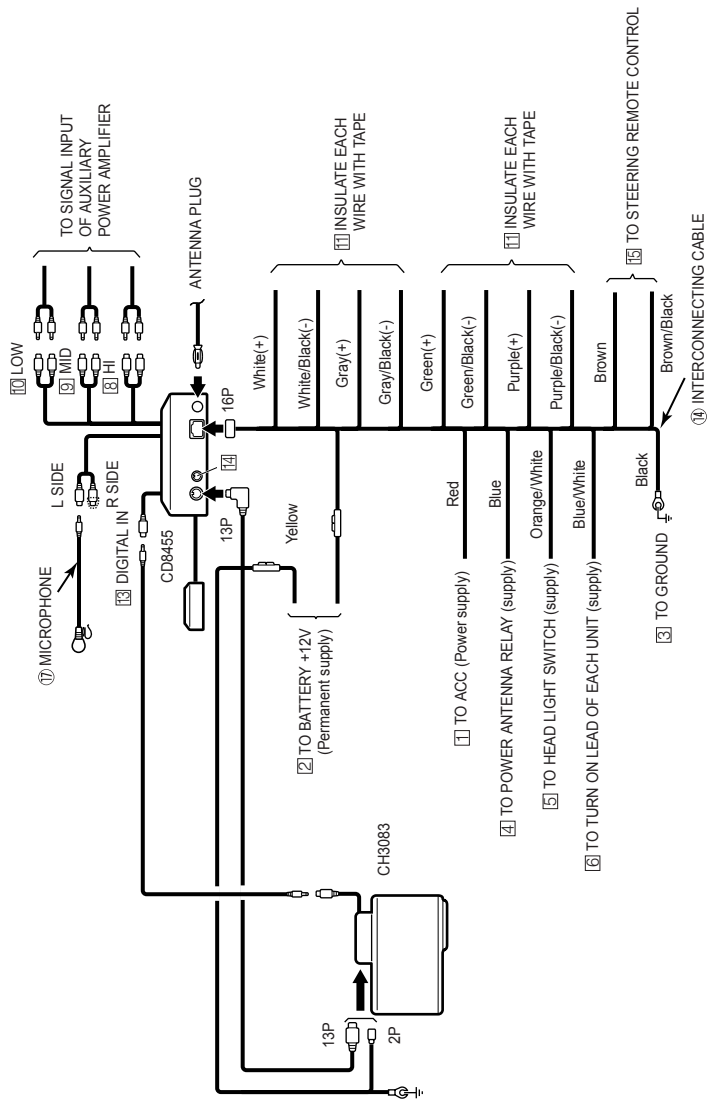

Caution

Never connect the power supply to the speaker leads, otherwise it causes damage to the main unit.

How to contact customer service

Should the product require service, please contact your nearest Eclipse dealer.

<U.S.A/CANADA>

DIVISION OF FUJITSU TEN CORP. OF AMERICA
19600 SOUTH VERMONT AVENUE, TORRANCE, CA 90502
Phone: (310) 327-2151

<AUSTRALIA>

FUJITSU TEN (AUSTRALIA) PTY LTD.
ECLIPSE AUSTRALIA
Phone: 1800-211-411

<MALAYSIA>

Cobra Malaysia. Sdn, bhd.
Level 5, Axis Plaza, Jalan U1/44, Glenmarie, 40150 Shah Alam,
Selangor D.E., Malaysia.
Phone: 03-5569-4200
Fax: 03-5569-4201

<SINGAPORE>

Cobra Singapore Pte Ltd
Trademart
60, Martin Road, # 05-20, Singapore 239065
Phone: 6737 2568
Fax : 6737 9538

<KOREA>

Transpectra Co., LTD.
115-16 nonhyun dong kangnam ku Seoul, Korea.
Phone: 02-540-4595
Fax: 02-2-540-4666

HYUNDAI AUTONET Co., Ltd.
1st FL. Namhyoung Bldg, 746-23 Yeoksam-Dong, Kangnam-Ku,
Seoul, Korea 135-080
Phone: 02-508-6001
Fax: 02-2-508-6067

<TAIWAN>

Sentrek Taiwan, LTD.
1, 9F, Lane 155, Section 3, Peishen RD., Shengkeng, Taipei Hsien,
222
Taiwan, R.O.C.
Phone: 02-2662-8110
Fax: 02-2662-8117

<THAILAND>

Sho-Ten Co., Ltd.
114/9 Soi Suwansawadi, Thungmahamek, Rama 4 Rd., Sathorn,
Bangkok 10120, Thailand.
Phone: 02-671-9610-12
Fax: 02-671-9614

Memo

.....

Memo

.....

Memo

.....

IMPORTANT

**RECORD YOUR “KEY CD”
OR “MEMORY STICK
(SECURITY CODE)”
HERE...**

**STORE YOUR “KEY CD”
OR “MEMORY STICK
(SECURITY CODE)”
ALONG WITH YOUR
OWNER’S MANUAL.**



This device complies with part 15 of the FCC Rules. Operation is subject to the condition that this device does not cause harmful interference.

CUSTOMER NOTICE

Please retain this booklet and write in the serial number of your CD8455 for identification. The serial number is labeled or stamped on the chassis.

Serial No.

FUJITSU TEN LIMITED
Contact: FUJITSU TEN CORP. OF AMERICA
19600 So. Vermont Avenue, Torrance, CA 90502
Call: 800-233-ECLIPSE

www.eclipse-web.com

"ECLIPSE" is a registered trademark of FUJITSU TEN LIMITED in 48 countries including the U.S. and Japan.

090001-1467A700 0504 (F.O)