

ECLIPSE®

by FUJITSU TEN

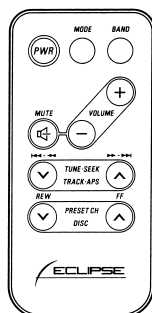
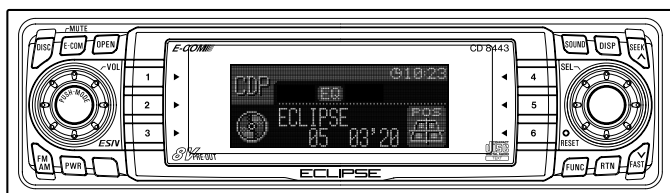

MODEL **CD8443**

ESN E8 High-Power CD Receiver with
Multi Control and Remote



OWNER'S MANUAL

We appreciate your purchase of this receiver.
Please read through this manual for correct operation.
We suggest that after reading it you keep this manual
in a safe place for future reference.

For your safety in using the CD8443

Warnings and caution signs, illustrated below, are posted throughout this manual as well as on the CD8443. They show safe and correct ways to handle the product so as to prevent personal injury to you and others and avoid damage to property.

Before reading through the manual, take time to read through and learn the important information listed in this section.

 Warning	This sign indicates a situation in which incorrect handling through disregard of a sign might result in death or serious personal injury.
 Caution	This sign indicates a situation in which incorrect handling through disregard of a sign might result in personal injury or may result solely in damage to property.

Warning

- Do not modify this system for use other than that specified herein. Also, do not deviate from the installation procedures described herein; Eclipse will not be held liable for damages including, but not limited to serious injury, death or property damage resulting from installations that enable unintended operation.
- This unit is intended for operation in DC 12-volt, negative-grounded vehicles only. Never use it in 24-volt vehicles such as heavy trucks or diesel cars with cold-region specifications.
- Do not change CDs while driving. Doing so may result in an accident.

 **Warning**

- Do not place the vinyl storage bag over a person. It may cause a serious accident or death by suffocation.
- Do not adjust the controls while driving the car. To adjust the controls, stop the car in a safe location.
- To prevent accidents, store batteries for the remote control out of the reach of small children. In case a child swallows a battery, consult a physician immediately.
- Do not disassemble or rebuild this product. Doing so may cause an accident, fire or electrical shock.
- When it is necessary to replace the fuse, always use a fuse of the correct rating (number of amperes). Use of fuses with higher amperage ratings may cause a fire.
- Do not operate the product in a malfunctioning condition, for instance, when the audio does not play. Doing so may result in an accident, fire or electrical shock.
- If an abnormal situation occurs, such as foreign matter entering or liquid splashing on the product, or smoke or a strange odor emitting from the unit, shut off the product immediately and consult the dealer from whom you purchased it. Continued operation may cause an accident, fire or electrical shock.
- Do not install this product in locations where it may obstruct the driver's view, or where it may endanger passengers in the vehicle. Otherwise, an accident or injury may result.
- Do not install this product in locations where it may interfere with the operation of the steering wheel, shift lever, brake pedal, etc. Otherwise, an accident or injury may result.
- When installing this product, never use existing nuts or bolts that secure parts of the fuel tank, or the steering or braking systems. Otherwise improper steering or braking or a fire may result.

 **Warning**

- To prevent a short circuit from occurring, disconnect the battery's negative terminal before installing this product. Otherwise, an electric shock or injury may result.
- When using an existing nut and/or bolt from the vehicle to ground this product, do not use any that secure parts of the steering or braking systems. Otherwise, an accident may result.
- Bundle cables and harnesses with electrical tape or wire ties to prevent them from interfering with moving parts. If they should entangle the steering wheel, shift lever or brake pedal, an accident may result.
- Never supply power to another electrical appliance by splicing or tapping into this product's power lead (wire). Otherwise, the current capacity of the wire will be exceeded, resulting in a fire or electric shock.
- Never attempt to disassemble or modify the product. Otherwise, an accident, fire or electric shock may result.
- When installing the product into a vehicle with a passenger side air bag, do not secure it to the air bag's cover or in places where it may impede air bag deployment. Otherwise, proper air bag operation may not be ensured in the event of an accident, causing injury or death.
- When making holes using a drill or similar tool, be sure to wear protective eyewear. Otherwise, an injury such as loss of eyesight may result.
- Exposed wires must be insulated with electrical tape. Otherwise, a short circuit, fire, or electric shock may result.

 **Caution**

- Play the audio at a moderate volume level that permits you to hear sounds from outside the car. Driving without being able to hear outside sounds may result in an accident.
- Keep foreign objects out of the disc slot. They may cause fire or electrical shock. Another possibility is that discs may be damaged or become stuck.
- Do not stick your fingers or hands into the disc slot. Doing so may cause personal injury.
- This product must be operated only as on-board equipment, or it may cause electrical shock or injury.
- Do not play distorted sounds for long periods of time; the speakers may overheat and cause a fire.
- Never use batteries other than those specified. Do not mix new and old cells. Doing so may cause a fire or personal injury due to a battery explosion or chemical leaks.
- Pay attention to the (+) and (-) polarity of the battery when installing them in the product. Incorrect installation may cause personal injury or product damage spoilage due to a battery explosion or chemical leakage.
- For best results, this product should be installed by a professional installer.
Contact the dealer whom you purchased the product for an appointment.
- When installing this product, be sure to use the supplied mounting hardware. If parts other than those supplied are used, the unit may be damaged internally, or may not be held in place securely and become dislodged.



Caution

- Avoid installing this product in places where it may get wet, such as near windows, or in places that are moist or dusty. Presence of liquid, moisture or dust inside this product can cause short circuiting, resulting in smoke or fire.
- Do not install this product in locations where it cannot be fastened securely, such as places subject to frequent vibration. Otherwise, it may become dislodged and cause an accident or injury.
- Do not block this product's vent or heat sink. If either is blocked, excessive heat build-up may occur and cause a fire.
- If this product is not connected properly, a short circuit, fire or accident may occur.
- When routing cables, use care so that they do not contact sharp metal parts such as brackets or screw tips. Otherwise, a short circuit, electric shock, fire or accident may result.
- Do not obstruct the vent on this product. If blocked, excessive heat build-up may occur and cause a fire.

Table of Contents

Operating precautions.....	10
Notes on operation	10
About compact discs	11
About cleaning a CD	13
Names of controls and parts	14
ESN (Key CD) security operating procedure	15
How to program the Key CD	15
How to cancel the Key CD	16
How to change the Key CD	17
How to resume normal operation (ESN security lock out).....	17
What happens if an incorrect CD is inserted?	18
How to turn the security indicator on/off	19
How to read the Electronic Serial Number	19
Basic operation	20
Turning the power on and off	20
Listening to a CD.....	21
Listening to the tuner	22
Adjusting audio volume	23
Switching audio control modes.....	24
Enabling the loudness control	26
Making changes with Display Adjustment Mode	27
Making changes with Function Mode	30
Others.....	34
How to operate the CD player.....	38
Listening to CDs	38
Advancing to the next track or returning to the beginning of the track being played	39
Fast Forward/Rewind	39
Playing the beginning of tracks (SCAN).....	39
Repeating the same track (REPEAT).....	40
Playing tracks in random order (RANDOM)	40
Switching a CD to pause/play	41
Ejecting the disc	41
Creating a title for a CD.....	42
Changing a previously set title	44
Deleting a previously created title	45
Changing the number of CD titles	46
Displaying CD text.....	47

How to operate the MP3 player	48
About MP3.....	48
Listening to MP3 file.....	51
Advancing to the next track (file) or returning to the beginning of the track (file) being played	52
Skipping to the next or previous folder	52
Return to the root directory of the CD	52
Playing the beginning of files (SCAN)	53
Repeating the same file (REPEAT).....	53
Playing files in random order (RANDOM)	54
Displaying title	55
How to operate the tuner	56
Tuning to a station.....	56
Entering stations into memory automatically (The automatic preset mode: ASM)	57
Manually setting stations into memory	58
Preset station scan.....	59
Setting a station name.....	60
Deleting a station name.....	62
Changing the number of bands.....	63
FM reception characteristics	64
How to operate the Sound Adjustment Mode	66
About Sound Adjustment Mode.....	66
Operations during Normal Mode	73
Operations during Pro Mode	86
How to use the Card remote control.....	98
Precautions in use of the remote control.....	98
Cleaning the remote control	98
Turning the power on/off	99
Adjusting the audio volume	99
Switching playback modes	100
How to play the tuner	100
How to play CDs.....	101
Enabling the optional E-COM feature.....	102
Switching the remote control settings.....	103
Replacing the battery	104

How to use an optional NOB remote control 105

Turning the power on/off	105
Adjusting the audio volume	105
Switching playback modes	106
How to play the tuner	106
How to play CDs.....	107
Illuminating the NOB remote control	108
Enabling the optional E-COM feature.....	108
Switching the remote control settings.....	109
Replacing the battery	110

How to operate the receiver with an optional CD changer connected..... 112

Listening to a CD.....	112
Advancing to the next track or returning to the beginning of the track being played	112
Fast Forward/Rewind	113
Playing the beginning of tracks (SCAN).....	113
Repeating the same track (REPEAT).....	114
Playing tracks in random order (RANDOM)	114
Skipping to the next or previous CD.....	115
Specifying a CD to play	115

Others 116

Connecting Portable Audio Players to the AUX Jack.....	116
--	-----

If you have a question:..... 117

Displayed information (for troubleshooting).....	118
--	-----

Specifications 121

Before installation 122

Components	122
Setting the system-selector switch	122
Installation angle	123

Mounting instruction 124

Mounting the main unit.....	124
Names of lead wires and destinations	126
System	127

Operating precautions

<Your CD8443 will perform well over a long period of time through correct handling and care.>

Notes on operation

- For your safety, play only at volume levels that allow outside sounds to be heard.

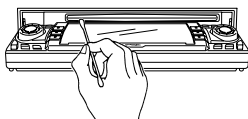
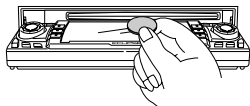

- We recommend using with this player a disc with the logo shown to the left.
- You can play music CDs (CD-R/CD-RW) on this player. Be sure to use discs that have been properly processed.

Depending on the editing equipment used, some discs may not play properly.

- Do not insert anything other than a CD into the disc slot.

Do not insert any foreign objects, such as coins or credit cards, into the disc slot. Be especially watchful of children's mischief in this regard.

- Avoid severe mechanical shock.

When the player is subjected to severe vibration while traveling over a rough surface, playback may be intermittent. When a situation like this occurs, resume playback after returning to a smoother road.

- About dew condensation.

In cold or rainy weather, just as the interior glass surface gets fogged, dew (water condensation) may also settle on the deck. When this occurs, disc playback may become intermittent or impossible. Dehumidify the air in the vehicle for a while before resuming playback.

- Cleaning the disc slot.

The disc slot tends to get dusty. Clean it occasionally to prevent accumulated dust from scratching the discs.

About compact discs

- The signal recorded on a compact disc is read by a laser beam, so nothing touches the disc surface. A scratch on the recorded surface or a badly warped disc may cause deteriorated sound quality or intermittent playback. Observe the following precautions to ensure high quality sound performance:

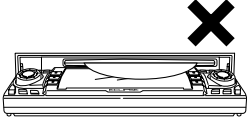

- Do not leave an ejected disc in the disc slot for very long; the disc may warp. Discs should be stored in their cases and kept away from high temperature and humidity.

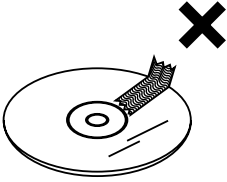

- Do not stick a piece of paper or tape on, nor write on or scratch either side of a disc.

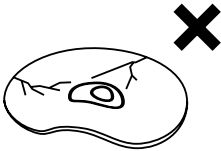

- Discs spin at a high speed inside the deck. Keep cracked or warped discs out of the player to avoid damaging it.

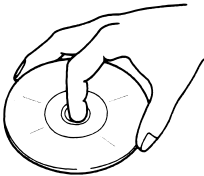

- Avoid touching the recorded surface when handling a disc; handle discs by their edges.

About brand new CDs

- You may notice that some brand new discs are rough around the center hole or outside edge. Remove the rough edges with the side of a ballpoint pen, etc. Rough edges may prevent proper loading in the deck. Flakes from the rough edges may also stick to the recorded surface and interfere with playback.

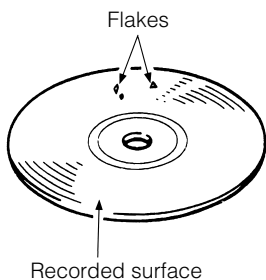
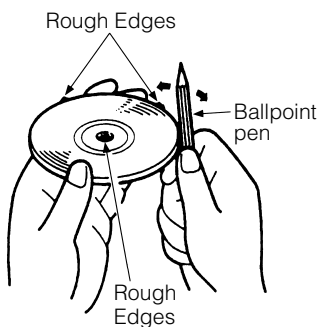

About CD accessories

- Do not use accessories (stabilizers, protective seals, laser lens cleaners, etc.) sold for "improving sound performance" or "protecting CDs." The changes in CD thickness or outside dimensions made by these accessories may cause problems in the player.

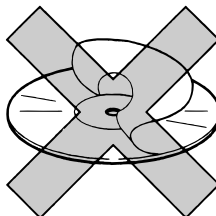

- Please be sure NOT to attach any ring-shape protector (or other accessory) to your discs. Those protectors are commercially available and said to protect disc and to improve sound quality (and antivibration effect), but they can do more harm than good in regular uses. The most common problems are Insert/Eject related problems and "No playback" problems due to the protector ring that came off in the disc mechanism.

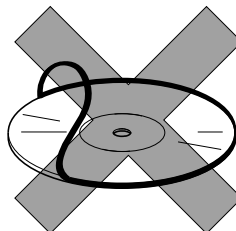

About borrowed CDs

- Do not use a CD with glue or remnants of adhesive tape or labels. They may cause the CD to get stuck inside or damage the deck.

How to remove CDs

- When removing the ejected disc, pull it straight out along the slot. Pressing downward in the process may scratch the recorded surface of the disc.

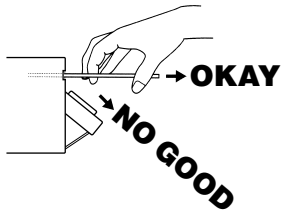

About irregularly-shaped CDs

- Specially-shaped CDs, like heart-shaped or octagonal CDs, cannot be played. Do not attempt to play them, even with an adapter, since they may damage the player.

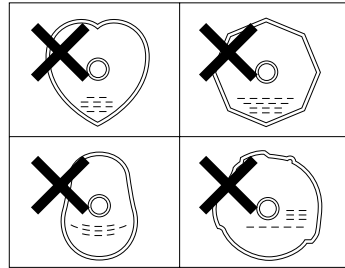

About cleaning a CD



- Use a commercially available compact disc cleaner to clean a CD, wiping lightly from the center to the edge.

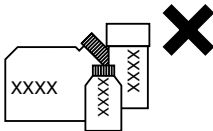

- Do not use benzine, thinner, LP record spray or other cleaners on CDs. They may damage a CD's finish.

Names of controls and parts

Front view

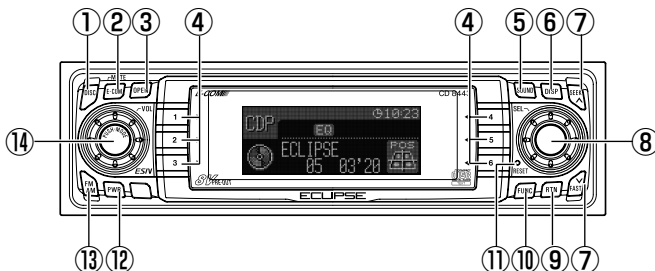

With the front open

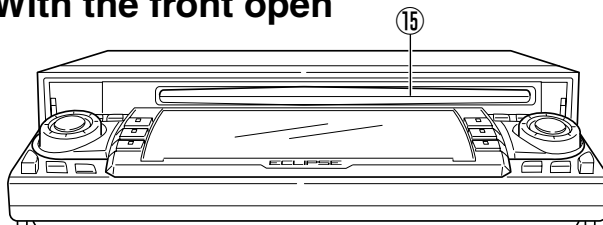

 **Caution** Never place an object or rest your hands or the like on the front panel.

①	[DISC] button	Switches disc modes and switches to AUX mode.
②	[E-COM] button*	Activates and deactivates mute.
③	[OPEN] button	Opens/closes front panel and adjusts angle.
④	Buttons [1] to [6]	Selects radio preset channels and performs disc mode functions.
⑤	[SOUND] button	Turns the sound adjustment mode ON/OFF.
⑥	[DISP] button	Turns the display adjustment mode ON/OFF and switches screen display.
⑦	[SEEK ^ / FAST V] button	Automatically finds radio reception and fast forward/rewind.
⑧	[SEL] button	Selects radio stations and CD tracks.
⑨	[RTN] button	Returns to previous screen.
⑩	[FUNC] button	Turns the function mode ON/OFF.
⑪	[RESET] button	Resets deck functions to default settings.
⑫	[PWR] button	Turns deck power ON/OFF.
⑬	[FM AM] button	Switches to radio mode and switches radio bands.
⑭	[AUDIO CONTROL] button	Adjusts volume and performs other functions.
⑮	Disc slot	Inserts compact discs.

*: Double function button → "E-COM" & "MUTE" functions

ESN (Key CD) security operating procedure

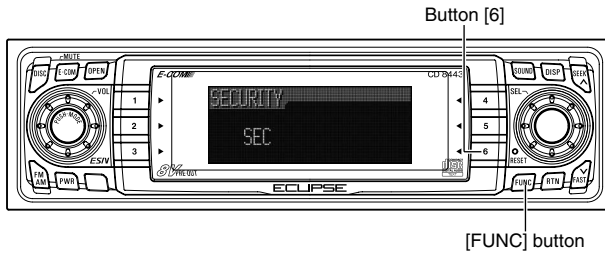

How to program the Key CD

- 1** Check that the Power is OFF.
- 2** Press and hold button [6], then the [FUNC] button, and hold both for more than one second.
 A [SEC] message appears, then in two seconds it will change to [DISC].
 The front panel opens; the CD8443 is now ready to accept your Key CD in the CD slot.
- 3** Insert the CD into the slot.
 The front panel closes.
 A [SEC] message appears, the front panel opens, then the Key CD is ejected.



- If there is a problem with the inserted CD, an [ERR] message will appear for two seconds and the CD will be ejected. Reinsert the ejected CD.
- If a CD causes the [ERR] message to appear twice in a row, a [CHANGE] message will appear for two seconds. Try another CD.
- The Security indicator will flash whenever the vehicle's ignition is switched off.

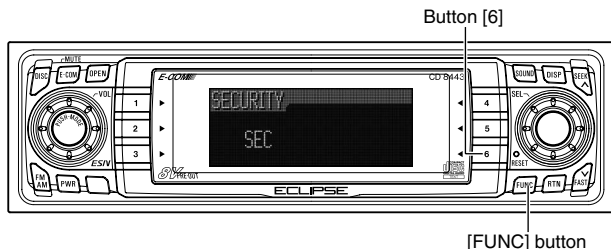

How to cancel the Key CD

- 1** Turn OFF the Power.
- 2** Press and hold button [6], then the [FUNC] button, and hold both for more than one second.

A [SEC] message appears, then in two seconds it will change to [DISC].

The front panel opens; the CD8443 is now ready to accept your Key CD in the CD slot.

- 3** Insert your Key CD into the slot.

The front panel closes.

A [CANCEL] message appears, the front panel opens, then the Key CD is ejected.

The Key CD is cancelled.



- This process cancels the protection for the ESN deck.
- If power to the ESN deck is disconnected, then reconnected, a Key CD will not need to be inserted in order to return the unit to normal operation.
- Inserting a CD other than the Key CD will not cancel the protection. Instead, the display will show [ERR] for two seconds, then the normal CD playback mode will activate.

How to change the Key CD

- 1** First, cancel the existing Key CD.

Refer to “How to cancel the Key CD.”

- 2** Next, program a new Key CD.

Refer to “How to program the Key CD.”

How to resume normal operation (ESN security lock out)

If power is disconnected while ESN security is active (a Key CD was programmed), operation is disabled until power is restored and the unit unlocked. Follow this procedure to resume normal operation.

- 1** When the power is turned on after disconnecting the battery power, a [SEC] message will appear for two seconds. Thereafter, the message changes to [DISC] and the CD8443 is ready to accept your Key CD into the slot.

- 2** Insert your Key CD.

If the correct CD is inserted, an [OK] message will appear for two seconds and the CD will begin playing.



- If an incorrect CD is inserted, an [ERR] message will appear for two seconds, after which the CD will be ejected.
- You must use the same CD used for Key CD programming; a duplicate CD may not work properly.

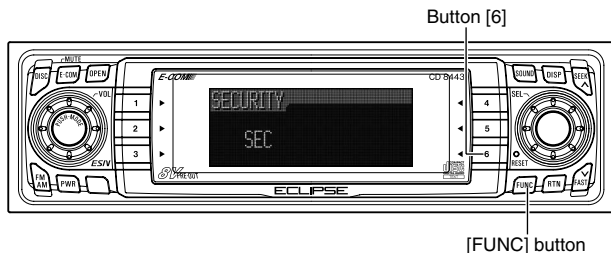

What happens if an incorrect CD is inserted?

- 1 An [ERR] message will appear, then change to a flashing [DISC], then the CD will be ejected.
You will have five uninterrupted attempts to insert the correct CD.
- 2 After the 5th incorrect attempt, the display reads [HELP].
- 3 If [HELP] appears on the screen, press button [6], then the [FUNC] button, and hold them for five seconds.
- 4 Press the [FUNC] button.

You will have five more attempts the correct disc.



Number of errors: Numbers indicated the number of errors that occurred.

● Note ●

If after 10 tries the correct Key CD is not inserted, the display reads [CALL800]; the unit must be returned to Eclipse to be reset. In this case, please contact your Eclipse dealer for assistance or call Eclipse directly at (800) 233-2216.

Your key CD can be easily forgotten. Write the album name in a reminder note (See Page 133).

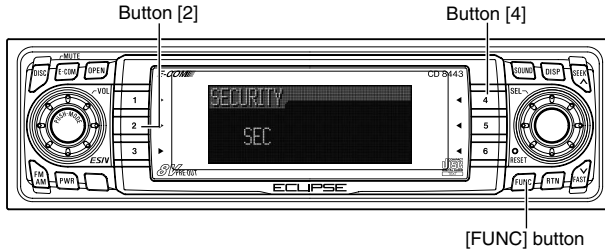

How to turn the security indicator on/off

Once ESN security is activated, the indicator flashes whenever the vehicle's ignition is turned off, warning potential thieves that the unit is protected. However, if you do not want this visible deterrent, it may be turned off.

- 1** With the power OFF, press button [2], then the [FUNC] button and hold both for more than one second.
- 2** [IND. FLASH] or [IND. -----] appears on the display.

[IND. FLASH] means the security indicator will flash when the vehicle's ignition is off, and [IND. -----] means it will not. Repeat the above steps to reactivate the flash mode.

How to read the Electronic Serial Number

- 1** Turn OFF the Power.
- 2** Press button [4], then the [FUNC] button, and hold both for more than one second.

[ESN] appears on the display, followed by an eight-digit number; this number is your electronic serial number (ESN). You may use this number to identify your Eclipse CD8443 in the event it is recovered after being stolen.

Basic operation

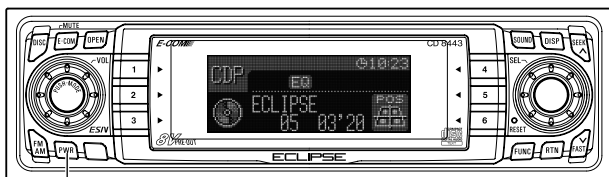

[PWR] button

This section covers basic operating procedures. For additional details, please refer to the sections on specific functions.

Turning the power on and off

Turning the power on and off.

When the power is turned on, the state used when the power was turned off such as CD and tuner playing is restored.

When the vehicle has no ACC position on the ignition switch, care is needed when turning off the deck. Follow Step 2 or Step 3 when turning off the power.

1 When power is OFF, press the [PWR] button.

When the unit is in ACC OFF mode, press the [PWR] button once and it will change to Standby mode. When you press the [PWR] button again, the power will come on.

2 When power is ON, press the [PWR] button for less than two seconds.

The unit will change to Standby mode.

3 When power is ON, press the [PWR] button for more than two seconds.

The unit will change to ACC OFF mode.



If a car is not equipped with an ACC position (for example, a European car), keep the [PWR] button depressed for more than two seconds.

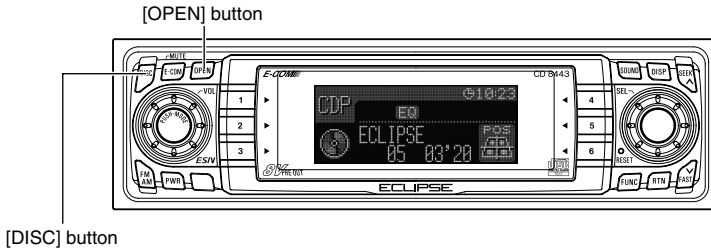

Listening to a CD

- 1** Press the [OPEN] button.

The front panel opens.

- 2** Insert a CD into the disc slot, label side up.

The CD will immediately start playing.



When a CD is already loaded, press the [DISC] button to switch to the CD mode.

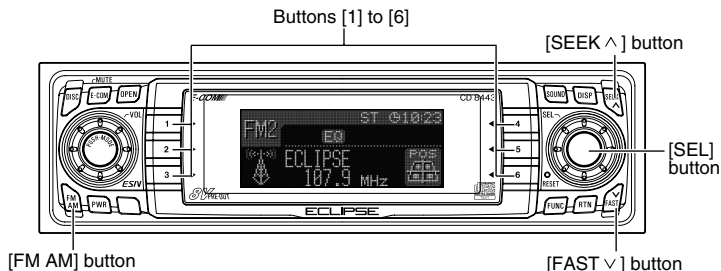

Listening to the tuner

- 1 Press the [FM AM] button.

This will turn the tuner on.

- 2 Press the [FM AM] button to switch to the desired FM or AM bands.

For example, radio bands will switch from FM1 → FM2 → FM3 → AM1 with each press of the button. (Depends on memory function setting, described on page 63.)

- 3 Turn the [SEL] button to the left or right to tune to a station.

Turn to the right: Tunes to higher frequencies.

Turn to the left: Tunes to lower frequencies.

- 4 Press the [SEEK ^ /FAST v] button to start the automatic station search.

[SEEK ^] button: Starts searching toward higher frequencies.

[FAST v] button: Starts searching toward lower frequencies.



If stations have been stored in memory, pressing a button from [1] to [6] will directly select a station. (Refer to the section “Manually setting stations into memory” on page 58)

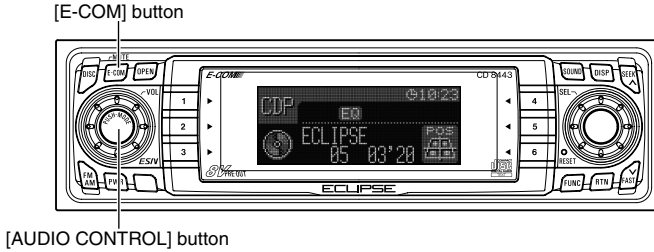

Adjusting audio volume

- 1 Turn the [AUDIO CONTROL] button to the left or right.

Turn to the right: Increases the volume.

Turn to the left: Decreases the volume.



Press the [E-COM] button for more than one second if E-COM is connected and less than one second if E-COM is not connected to cut the volume or restore it instantly.



Do not adjust the volume or other controls while driving the vehicle. Do so only while parked in a safe location.

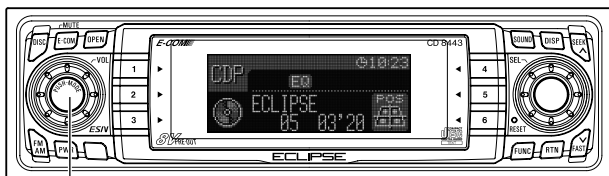

[AUDIO CONTROL] button

Switching audio control modes

Various audio control modes may be fine-tuned using this procedure.

- 1 Press the [AUDIO CONTROL] button for less than one second to select the item to be adjusted.

Modes will switch in the order shown below each time the button is pressed.

VOL → BASS *1 → TREB *1 → BAL *2 → FAD *2 → NON-F *3

*1: When the sound adjustment mode is in normal mode, this adjustment is not available. (Refer to page 73.)

*2: When the sound adjustment mode is set to pro mode, or if the position selector is "ON" in normal mode, this adjustment is not available. (Refer to pages 80 and 86.)

*3: When the sound adjustment mode is pro mode, this adjustment is not available. (Refer to page 86.)

VOL (VOLUME) Mode

Adjusts volume. Volume level can be adjusted for each source (CDP/CDC, FM and AM).

Turn the [AUDIO CONTROL] button to the left or right.

Turn to the right: Increases the volume.

Turn to the left: Decreases the volume.

BASS Mode

Adjusts bass level. In pro mode, bass can be adjusted for each source (CDP/CDC, FM and AM).

Turn the [AUDIO CONTROL] button to the left or right.

Turn to the right: Emphasizes low sounds.

Turn to the left: Softens low sounds.

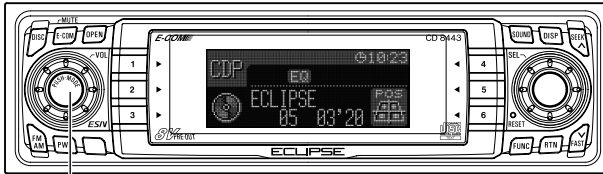

[AUDIO CONTROL] button

TREB (TREBLE) Mode

Adjusts treble level. In pro mode, treble can be adjusted for each source (CDP/CDC, FM and AM).

Turn the [AUDIO CONTROL] button to the left or right.

Turn to the right: Emphasizes high sounds.

Turn to the left: Softens high sounds.

BAL (BALANCE) Mode

Adjusts left/right speaker balance.

Turn the [AUDIO CONTROL] button to the left or right.

Turn to the right: Emphasizes right speakers.

Turn to the left: Emphasizes left speakers.

FAD (FADER) Mode

Adjusts front/rear speaker balance.

Turn the [AUDIO CONTROL] button to the left or right.

Turn to the right: Emphasizes front speakers.

Turn to the left: Emphasizes rear speakers.

NON-F (NON-FADER) Mode

Adjusts non-fader level (for connected sub-woofers, etc.).

Turn the [AUDIO CONTROL] button to the left or right.

Turn to the right: Increases level.

Turn to the left: Decreases level.

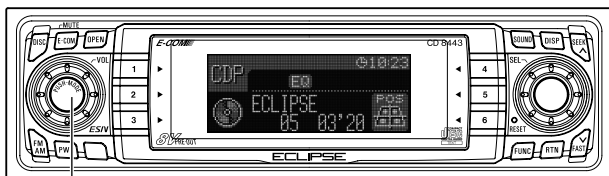

[AUDIO CONTROL] button

Enabling the loudness control

The loudness control may be turned on to emphasize low and high frequencies at low volume levels.

Loudness compensates for the apparent weakness of low and high frequencies at low volume by boosting the bass and treble levels.

- 1 Press and hold the [AUDIO CONTROL] button until the [LOUD ON] display appears on the screen.



To disable the loudness feature, repeat the above procedure to display the [LOUD OFF] indication.

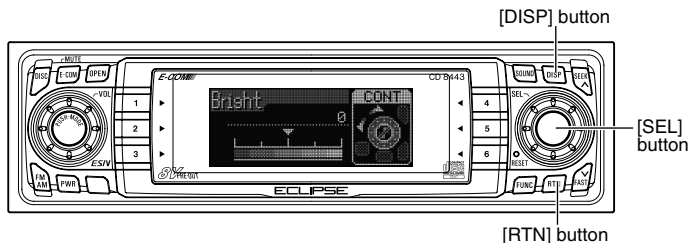

Switching the brightness

Adjust the display brightness to the best level.

- 1 Turn the [SEL] button to select Bright.**
The selected item will be highlighted.
- 2 Press the [SEL] button.**
The mode will change to luminance adjustment mode.
- 3 Turn the [SEL] button to adjust brightness.**
When the button is turned, the brightness level changes in the following order.

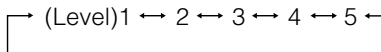

- 4 Press the [RTN] button.**
At this time, other adjustments can also be made in display adjustment mode.
- 5 Press the [DISP] button to exit display adjustment mode.**

Changing Illumination Color

You can change the button illumination color in the following way.

- 1 Turn the [SEL] button to select ILL.**
The selected item will be highlighted.
- 2 Press the [SEL] button.**
The screen for changing the illumination color will appear.
- 3 Turn the [SEL] button to select Green or Red.**
The selected item will be highlighted.
- 4 Press the [RTN] button.**
At this time, other adjustments can also be made in display adjustment mode.
- 5 Press the [DISP] button to exit display adjustment mode.**

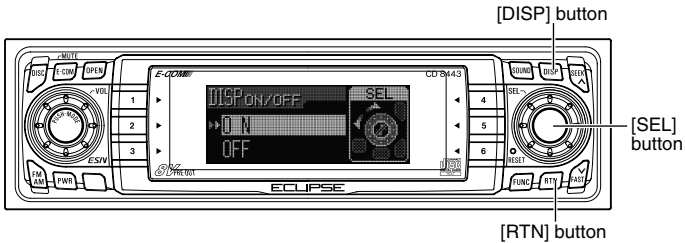

Disabling the display

You can turn the display on and off in the following way.

- 1 Turn the [SEL] button to select Disp on/off.**
The selected item will be highlighted.
- 2 Press the [SEL] button.**
The screen for turning the screen display on and off will appear.
- 3 Turn the [SEL] button to select ON or OFF.**
The selected item will be highlighted.
- 4 Press the [RTN] button.**
At this time, other adjustments can also be made in display adjustment mode.
- 5 Press the [DISP] button to exit display adjustment mode.**



ATTENTION

- When the display is OFF, when one of the buttons is activated, the screen display will come on within 6 seconds.
- When the OFF function is selected, the screen display will turn off. However, it is possible to adjust the display adjustment mode.

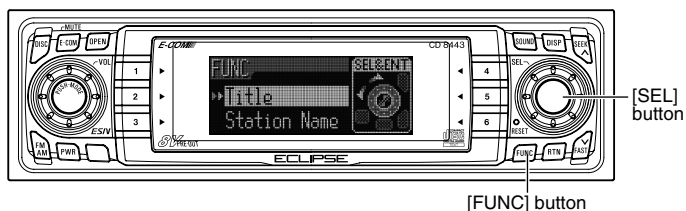

Making changes with Function Mode

A variety of settings can be changed.

- 1 Press the [FUNC] button.

The function mode is activated.



If you press the [FUNC] button during function mode, the adjustment mode is canceled and the mode returns to normal music mode.

- 2 Turn the [SEL] button in either direction to display setting items for selection.

When the button is turned, the setting item changes in the following order and the selected item is highlighted.

Title *1 ↔ Station Name *2 ↔ Guide Tone ↔ Memory Func *3
 ↓
 Clock Adjust ← → Clock on/off ← → Remote Func *4

*1: Cannot make settings other than for CD or CD changer operation.
 (Refer to page 42 for details on CD operation.)

*2: Cannot make settings other than for tuner operation.
 (Refer to page 60 for details on tuner operation.)

*3: Refer to page 46 for details on CD operation, and to page 63 for details on tuner operation.

*4: Refer to pages 103 and 109 for details on remote control operation.

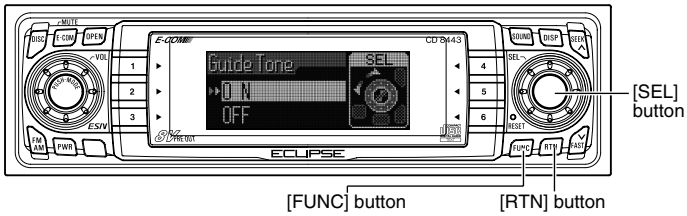

Disabling the guide tone feature (for button operation)

The receiver is set at the factory to emit a beep tone in response to button operation. The guide tone feature may be disabled in the following procedure:

- 1 Turn the [SEL] button to select Guide Tone.**
The selected item will be highlighted.
- 2 Press the [SEL] button.**
The guide tone mode will be switched ON/OFF.
- 3 Turn the [SEL] button to select ON or OFF.**
The selected item will be highlighted.
- 4 Press the [RTN] button.**
At this time, other adjustments can also be made in function mode.
- 5 Press the [FUNC] button to exit function mode.**

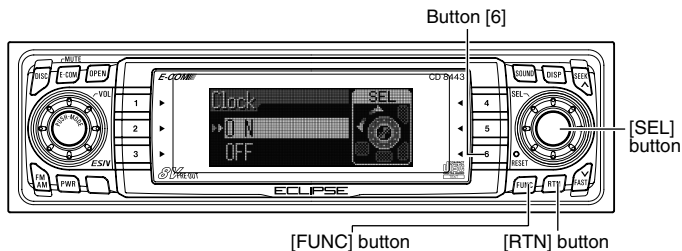

CLOCK DISPLAY on/off

Switches the clock display to ON/OFF.

- 1 Turn the [SEL] button to select Clock on/off.**
The selected item will be highlighted.
- 2 Press the [SEL] button.**
The clock display ON/OFF mode is activated.
- 3 Turn the [SEL] button to select ON or OFF.**
The selected item will be highlighted.
- 4 Press the [RTN] button.**
At this time, other adjustments can also be made in function mode.
- 5 Press the [FUNC] button to exit function mode.**



The clock display can also be turned on and off by pressing the [6] button while the power is turned off.

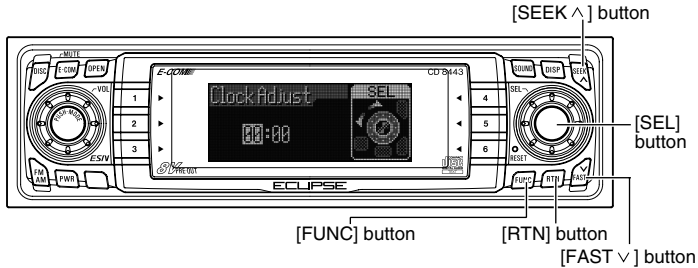

Setting the Time

This receiver uses the 12-hour display notation.

- 1 Turn the [SEL] button to select Clock Adjust.**
The selected item will be highlighted.
- 2 Press the [SEL] button.**
The clock adjustment mode is activated.
- 3 Turn the [SEL] button to display the item to be selected for adjustment.**
Hours, minutes or exact hour will be switched each time the button is turned.
- 4 Press the [SEEK ^ /FAST v] button.**
[SEEK ^] button: Turns the time forward.
[FAST v] button: Turns the time back.
To set the clock to 0 minutes (an exact hour), press the [SEEK ^ /FAST v] button.
For example:
At 3:29: Pressing the [SEEK ^ /FAST v] button returns to 3:00.
At 3:30: Pressing the [SEEK ^ /FAST v] button advance to 4:00.
- 5 Press the [RTN] button.**
At this time, other adjustments can also be made in function mode.
- 6 Press the [FUNC] button to exit function mode.**

[E-COM] button [OPEN] button

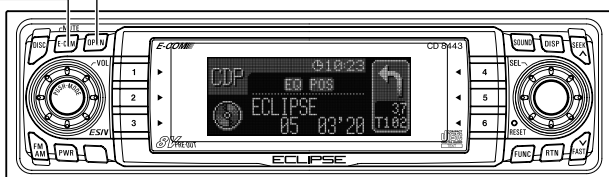

Others

Enabling E-COM feature

- 1 Press the [E-COM] button for one second.**

Pressing the button will switch the E-COM feature on or off.

Adjustment of the front panel angle

- 1 Press and hold the [OPEN] button for more than one second.**

While holding the button, the front panel opens regardless of the stage. The operation stops when the limit of adjustable angles is reached.

- 2 Press the [OPEN] button again for more than one second.**

The front panel will be completely closed.

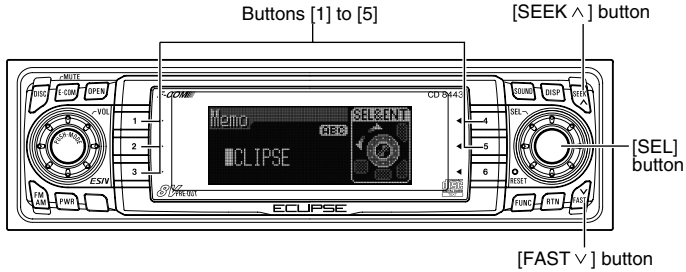

Displaying a memo

If memos have been set, a memo recorded corresponding to a number button [1] to [5] appears on the screen when the number button is pressed briefly while the power of the main unit is turned off.

Setting a memo

- 1 Press and hold any number button for more than two seconds while in the Standby mode.**

The state shifts to the MEMO setting mode.

- 2 Press the [SEEK ^] button to select the character type.**

Pressing the button will switch types from [ABC] (alphabet characters) to [123] (numeric characters) and then [!&?] (symbols).

- 3 Press either [SEL] or [FAST v] button to select the position in which to enter the character.**

The character will be inserted where the cursor is flashing:

[SEL] button: Moves the cursor to the right.

[FAST v] button: Advances the cursor to the left.

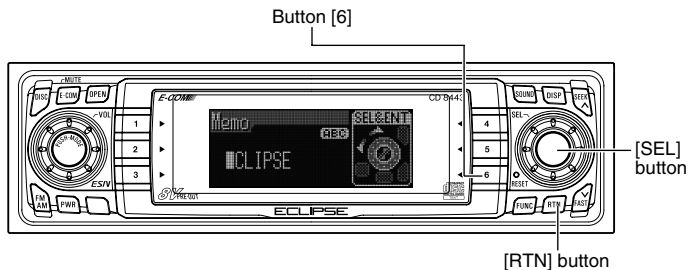

4 Turn the [SEL] button to the left or right to select characters.

Turn to the right: Advances the character forward in its type.

Turn to the left: Moves the character backward in its type.

[Upper-case alphabet characters] Initial value [A] [Right direction]

→A→B→C→…→X→Y→Z→

[Numeric characters] Initial value [1] [Right direction]

→1→2→3→…→8→9→0→

[Symbol] Initial value [!] [Right direction]

→!→"→#→\$→%→&→'→(→)→*→+→,→-→.→/→:→;→<→=→>→?→@→"→_→



- To change the type of character to be entered, repeat steps 2 and 3.
- A maximum of 10 characters may be entered per memo.
- A maximum of 5 memos may be stored.

5 Press the [RTN] button.

Memo settings are now completed.

Deleting a memo

1 Press the number button corresponding to the memo to be deleted for two seconds while the power is turned off.

2 Press the [6] button for more than two seconds.

The memo will be deleted.

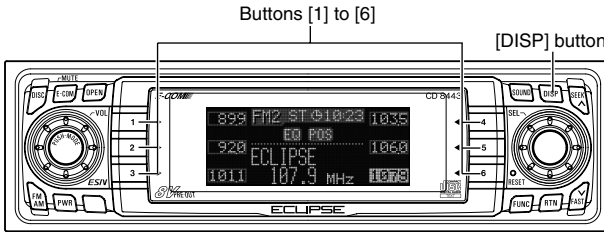

Changing the display mode

You can change the details that are shown in display mode in the following way.

- 1 Press the [DISP] button for one second or more. Each time the button is pressed in this way, the display switches between A mode and B mode.**

A mode: In this mode, the preset button functions are displayed.

When in tuner mode, the preset frequencies are displayed next to buttons [1] to [6] and these frequencies are highlighted when those signals are being received. When in disc mode, the button functions such as [SCAN], [RPT] and [RAND] that are used in disc mode are displayed next to buttons [4] to [6].

B mode: In this mode, the preset button functions are not displayed.

Operation assist function

In display adjustment mode, function mode and sound adjustment mode, the screen displays and button illumination help to guide you in carrying out operations.

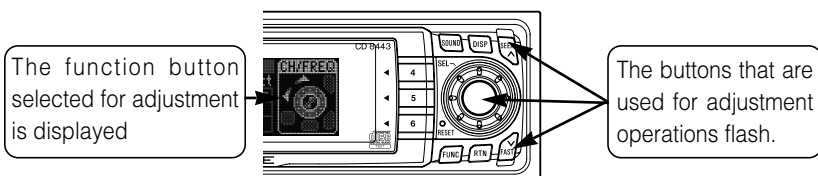

How to operate the CD player

[DISC] button

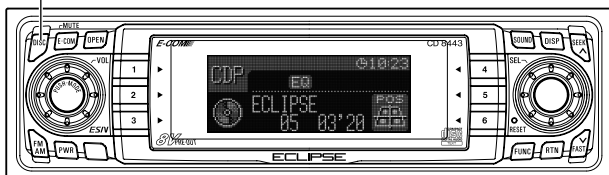

First press the [DISC] button to switch to the disc mode. It is assumed here that a CD has already been loaded into the unit.

Listening to CDs

- 1 Press the [DISC] button.

This starts CD play.

If an external CD changer is connected, each additional press of the [DISC] button will switch modes from CD changer 1 → CD changer 2 → CD player.

A changer or player with no discs loaded will be skipped.



- Playback may be intermittent when there is a scratch on a CD or when the recorded side is dirty.
- Only two external CD changers may be connected.

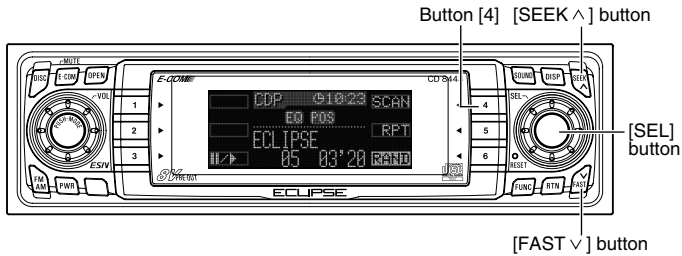

Advancing to the next track or returning to the beginning of the track being played

- 1 Turn the [SEL] button to the left or right.

Turn to the right: Advances to the next track.

Turn to the left: Returns to the beginning of the track being played. (Repeat turning for previous tracks.)

Fast Forward/Rewind

Fast forward or rewind the song currently being played.

- 1 Press and hold the [SEEK ^] or [FAST v] button.

[SEEK ^] button: Fast forward.

[FAST v] button: Rewind.

Playing the beginning of tracks (SCAN)

- 1 Press button [4].

Pressing the button causes the player to move up to the next track and play it for 10 seconds, then move up to the next track and play it for 10 seconds, and so on until the button is pressed again.



- To continue playing a desired track, press the button again to stop scanning.
- After the entire disc is scanned once, ordinary playback starts from the point where scanning started.

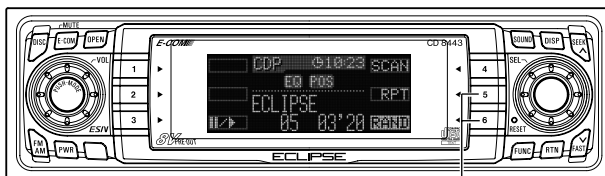

Buttons [5] and [6]

Repeating the same track (REPEAT)

- 1 Press button [5] to repeat the track being played.

To cancel, press button [5] again.

Playing tracks in random order (RANDOM)

- 1 Press button [6] to play the tracks in random order.

To cancel, press button [6] again.



ATTENTION

- Doing random playback, press button [5] to repeat the track being played. To cancel repeat play (go back to random play), press button [5] again.
During playback a particular track: The track being played is played repeatedly.
During searching: The following track is played repeatedly.
- Occasionally the same track happens to be played (selected) two or more times in a row; this is normal operation and is no sign of a problem.
- When any of the functions - "Playing the beginning of tracks," "Repeating the same track" and "Playing tracks in random order" - is selected, a message such as [SCAN], [REPEAT] or [RANDOM] appears on the display to verify the current function.

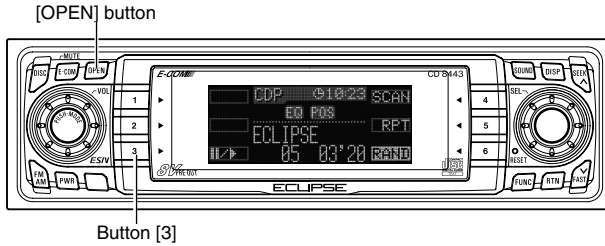

Switching a CD to pause / play

- 1 Press button [3].

It pauses playing a CD.
To cancel, press button [3] again.

Ejecting the disc

- 1 Press the [OPEN] button for less than one second.

The front panel opens fully and ejects the disc.

- 2 Remove the disc and press the [OPEN] button.

The front panel returns to the angle before the disc ejection. If left alone for 15 seconds after the disc ejection, the front panel returns to the angle before the disc ejection after the BEEP sound.



- Do not drive with the front panel open. The panel may cause unexpected personal injury during a panic stop, or the like.
- Do not attempt to close the front panel by hand. Doing so may damage the panel.

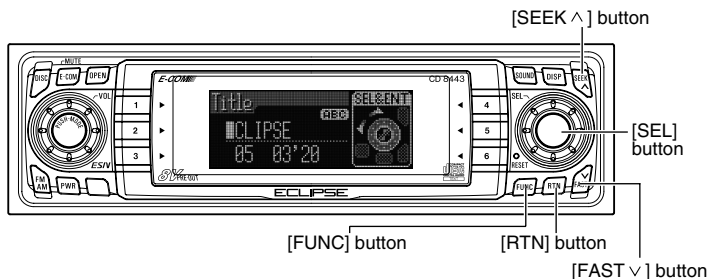

Creating a title for a CD

A CD title may be created, attached and displayed for your discs. If external CD changers are connected, a title for a CD will be created in the same way. It is assumed here that the CD to be titled is playing.



No CD text disc can be set.

- 1** Press the [FUNC] button while in the disc mode.
- 2** Turn the [SEL] button to select Title.
The selected item will be highlighted.
- 3** Press the [SEL] button.
The disc title setting mode is activated.
- 4** Press the [SEEK ^] button to select the character type.
Pressing the button will switch types from [ABC] (alphabet characters) to [123] (numeric characters) and then [!&?] (symbols).
- 5** Press either [SEL] or [FAST v] button to select the position in which to enter the character.
The character will be inserted where the cursor is flashing:
[SEL] button: Moves the cursor to the right.
[FAST v] button: Advances the cursor to the left.

6 Turn the [SEL] button to the left or right to select characters.

Turn to the right: Advances the character forward in its type.

Turn to the left: Moves the character backward in its type.

[Upper-case alphabet characters] Initial value [A] [Right direction]
⌈ A → B → C → … X → Y → Z ⌋
[Numeric characters] Initial value [1] [Right direction]
⌈ 1 → 2 → 3 → … 8 → 9 → 0 ⌋
[Symbol] Initial value [!] [Right direction]
⌈ ! → " → # → \$ → % → & → ' → (→) → * → + → , → - → . → / → : → ; → < → = → > → ? → @ → ' → _ ⌋



- To change the type of character to be entered, repeat steps 3 and 4.
- A maximum of 12 characters may be entered per title.
- 30 to 100 titles (changeable) can be stored (Use store).
- If the number of discs that can be memorized is exceeded, the information about the disc whose playing time is oldest is deleted.

7 Press the [RTN] button.

At this time, other adjustments can also be made in function mode.

8 Press the [FUNC] button to exit function mode.

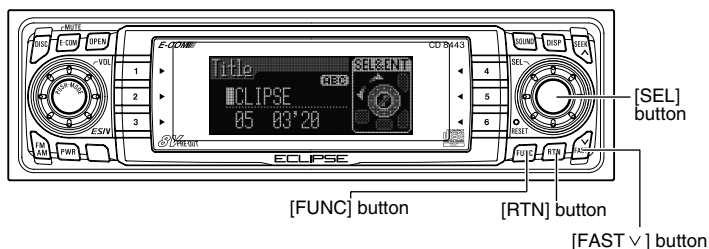

Changing a previously set title

If external CD changers are connected, a previously set title for a CD will be changed in the same way. It is assumed here that the disc mode is selected.

- 1** Press the [FUNC] button while in the disc mode.
- 2** Turn the [SEL] button to select Title.
The selected item will be highlighted.
- 3** Press the [SEL] button.
The disc title setting mode is activated.
- 4** Press either [SEL] or [FAST ∨] button to move the cursor to the position in the title for inserting or changing characters.
[SEL] button: Moves the cursor to the right.
[FAST ∨] button: Advances the cursor to the left.
- 5** Turn the [SEL] button to the left or right to select characters.
Turn to the right: Advances the character forward in its type.
Turn to the left: Moves the character backward in its type.



To leave a space blank, follow these steps.

1. Select and flash the space to be blank.
2. Turn the [SEL] button to make a blank space flashing.
3. Press the [SEL] button to move.

- 6** Press the [RTN] button.
At this time, other adjustments can also be made in function mode.
- 7** Press the [FUNC] button to exit function mode.

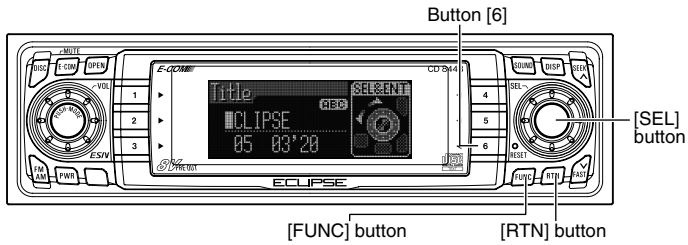

Deleting a previously created title

If external CD changers are connected, a previously created title for a CD will be deleted in the same way. It is assumed here that the disc mode is selected.

- 1** Press the [FUNC] button while in the disc mode.
- 2** Turn the [SEL] button to select Title.
The selected item will be highlighted.
- 3** Press the [SEL] button.
The CD title being played at this point will be deleted.
- 4** Hold the [6] button down for more than two seconds.
The title has now been deleted.

- 5** Press the [RTN] button.
At this time, other adjustments can also be made in function mode.
- 6** Press the [FUNC] button to exit function mode.

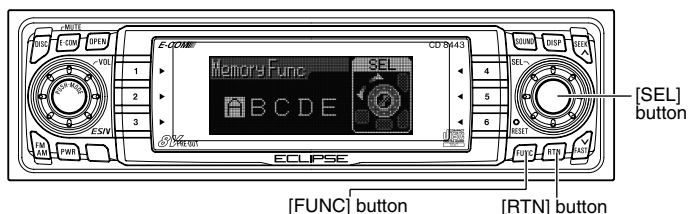

Changing the number of CD titles

The number of CD titles that can be set can be changed by changing the memory allocation. The number of CD titles is fixed for each pattern and the number of tuner bands that can be recorded is also changed at the same time.

1 Press the [FUNC] button while in the disc mode.

2 Turn the [SEL] button to select Memory Func.

The selected item will be highlighted.

3 Press the [SEL] button.

The mode will change to memory allocation address selection mode.

4 Turn the [SEL] button to select an address from A to E.

The patterns switches between the following. The characters for the selected item are highlighted and the memory allocation address changes.

MEMORY A (standard)	AM/FM: 1/3, CD title memory: 30 titles
MEMORY B	AM/FM: 2/5, CD title memory: 40 titles
MEMORY C	AM/FM: 1/3, CD title memory: 60 titles
MEMORY D	AM/FM: 2/5, CD title memory: 80 titles
MEMORY E	AM/FM: 3/8, CD title memory: 100 titles

5 Press the [RTN] button.

At this time, other adjustments can also be made in function mode.

6 Press the [FUNC] button to exit function mode.

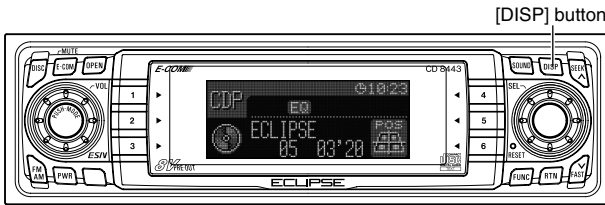

Displaying CD text

Only the built-in CD player supports CD TEXT. It can not be displayed with the optional CD changer. If the CD came with a logo shown below, it is recorded with a disc title and track titles. These information will be displayed during playback.



- 1 Press the [DISP] button for more than one second.

Pressing the [DISP] button while text is displayed scrolls the display in the order DISC title → TRACK title, and then the display stops with the TRACK title.

At this time, the display mode also switches between A mode and B mode. (Refer to the "Changing the display mode" section on page 37.)

How to operate the MP3 player

MP3 files can only be played when E-COM is connected.

About MP3



The making of MP3 files by recording from sources such as broadcasts, records, recordings, videos and live performances without permission from the copyright holder for uses other than personal enjoyment is prohibited.

What is MP3?

MP3 (MPEG Audio Layer III) is a standard format for audio compression technology. By using MP3, a file can be compressed to one-tenth the size of the original.

This deck has limitations on MP3 file standards and recorded media and formats that can be used.

Playable MP3 file standards

- Supported standards: MPEG-1 Audio Layer III
MPEG-2 Audio Layer III
- Supported sampling frequencies: 22.05, 44.1 (kHz)
- Supported bit rate: 8, 16, 24, 32, 40, 48, 56, 64, 80, 96, 112, 128 (kbps)
* Does not support free format.
- Supported channel modes: stereo, joint stereo, monaural

ID3 tags

MP3 files have an "ID3 Tag" that allows input of information so that data such as song title and artist can be saved.

This deck supports ID3v.1.0 and ID3v.1.1 tags.

Media

Media capable of playing MP3 includes CD-ROM and CD-R discs. Compared to CD-ROM media commonly used for music discs, CD-R discs are fragile in high temperature/high humidity environments and one section of the CD-R may become incapable of playback. Fingerprints or scratches on the disc may prevent playback or cause skipping during playback. Sections of a CD-R may deteriorate if left inside a vehicle for long periods of time. It is also recommended that CD-R discs be kept in a light-blocking case because the discs are vulnerable to ultra-violet light.

Format of discs

The format of discs to be used must be ISO9660 Level 1 or Level 2.

Control items for this standard are as follows:

- Maximum characters for folder names/file names: 15
- Allowable characters for folder names/file names: A~Z, 0~9, _ (underscore)
- Number of files possible on a single disc: 65535^{*1}

[Configuration example for CD supporting MP3]

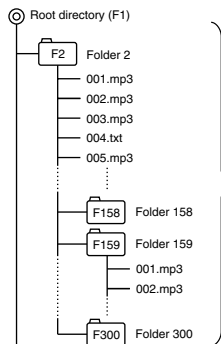

Number of files possible on a single disc is 65535.

Files aside from MP3 files (Example: 004.txt) also count as single files.

- Number of folders possible on a single disc: 300^{*2}
- Number of files possible in a single folder: 300

*1: Files aside from MP3 files (other than ".mp3" file extension) are also counted as single files.

*2: A root directory is counted as one folder.

File names

Only files with the MP3 file extension ".mp3" can be recognized as MP3 and played. Be sure to save MP3 files with the ".mp3" file extension. The "MP" letters of the file extension will be recognized whether entered as uppercase letters or lowercase letters.

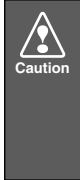

If the ".mp3" file extension is attached to a file other than an MP3 file, that file will be mistakenly recognized by the deck as an MP3 file and played, resulting in loud noise output that can damage the speakers. Be sure to avoid attaching the ".mp3" file extension to files that are not MP3 files.

Multi-sessions

Multi-sessions are supported, and playing of CD-R disc with annotated MP3 files is possible. However, when "Track at once" has been written, close the session or process the warning message. Standardize the format of each session without changing the format.

Playing MP3

When a disc with recorded MP3 files is inserted, the deck first checks all the files on the disc. Checking of the files will be completed within 10 seconds of disc insertion, and the first MP3 file will begin playing. If the disc check is not completed within 10 seconds, the player will go into standby mode. No sound is output while the deck is checking the files on the disc. It is recommended that the disc be recorded without files other than MP3 files and without unnecessary folders in order to speed up the checking of disc files by the deck.

Display order of MP3 file/folder names

Names of MP3 folders and files within the same level are displayed in the following order.

1. MP3 folders displayed first, by ascending order of numbers, letters.
2. Files displayed next, by ascending order of numbers, letters.

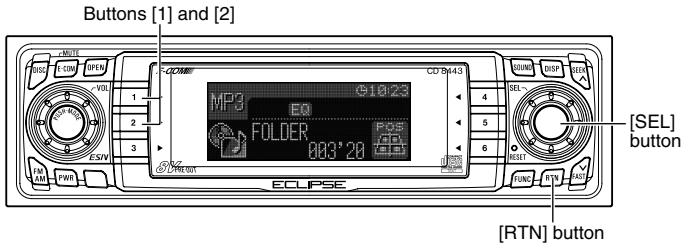

Advancing to the next track (file) or returning to the beginning of the track (file) being played

- 1 Turn the [SEL] button to the left or right.

Turn to the right: Advances to the next track (file).

Turn to the left: Returns to the beginning of the track (file) being played.

Repeat turning for previous tracks (files).

Skipping to the next or previous folder

- 1 Press button [1] or [2].

Button [1]: Selects the next folder.

Button [2]: Selects the next lower folder.

Return to the root directory of the CD

In the root directory, when a file cannot replay, the system will return to the first file that can perform a replay. (In the configuration example, the file is returning to 001.mp3. See page 49.)

- 1 Press the [RTN] button.

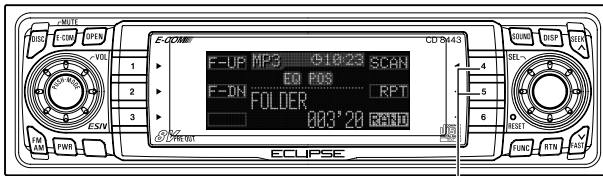

Buttons [4] and [5]

Playing the beginning of files (SCAN)

1 Press button [4].

Press the button briefly to play just the first 10 seconds of each song for all the files in the same layer of the folder being played.

Pressing the button until [FOLDER SCAN] is displayed will play just the first 10 seconds of the first song in each folder.



- To continue playing a desired file, press the button again to stop scanning.
- After the entire disc is scanned once, ordinary playback starts from the point where scanning started.

Repeating the same file (REPEAT)

1 Press button [5].

Press the button briefly to repeat the file being played.

Pressing the button until [FOLDER RPT] is displayed will repeat all the files in the same layer as the folder being played.

To cancel, press button [5] again.

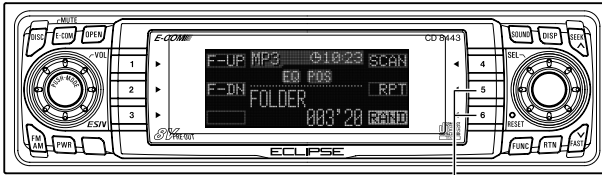

Buttons [5] and [6]

Playing files in random order (RANDOM)

1 Press button [6].

Press the button briefly to randomly play the files in the same layer as the folder being played.

Pressing the button until [FOLDER RAND] is displayed will randomly play the files in all the folders.

To cancel, press button [6] again.



- Doing random playback, press button [5] to repeat the file being played. To cancel repeat play (go back to random play), press button [5] again.

During playback a particular file: The file being played is played repeatedly.

During searching: The following file is played repeatedly.

- Occasionally the same file happens to be played (selected) two or more times in a row; this is normal operation and is no sign of a problem.

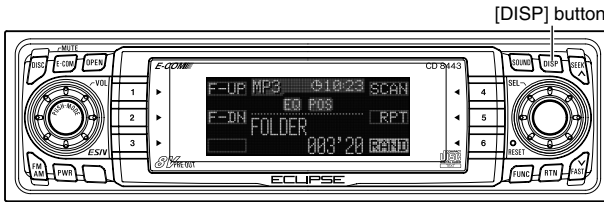

Displaying title

- 1 Press the [DISP] button for more than one second.

The title display details and display mode change as follows each time the button is pressed. (Refer to page 37 for details on the display mode.)

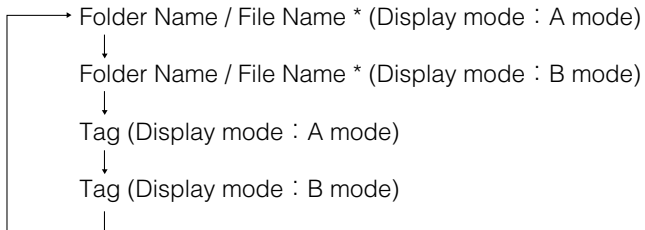

*: The display area shows a maximum of 10 characters and then scrolls to display the remaining characters. After the folder name is displayed, the file name will be displayed by scrolling. After the file name is scrolled, the display will be fixed.

How to operate the tuner

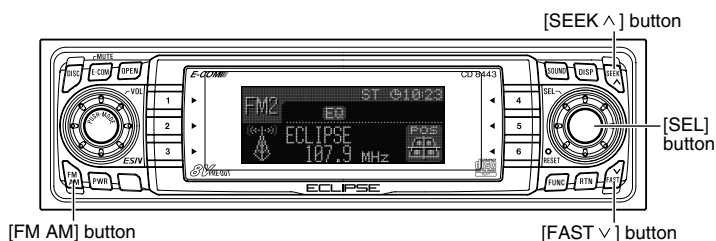

First, press the [FM AM] button to start tuner operation.

There are automatic and manual methods for setting stations in memory. The receiver will accept up to 24 stations in memory: six in AM and 18 in FM (6 each for FM1, FM2 and FM3.) (Initial setting)

Tuning to a station

- 1 Press the [FM AM] button to switch to the desired FM or AM bands.

Radio bands will switch from FM1 → FM2 → FM3 → AM in order each time the button is pressed.

- 2 Turn the [SEL] button to the left or right to tune to a station.

Turn to the right: Tunes to higher frequencies.

Turn to the left: Tunes to lower frequencies.

- 3 Press the [SEEK ^ /FAST v] button to start the automatic station search.

[SEEK ^] button: Starts searching toward higher frequencies.

[FAST v] button: Starts searching toward lower frequencies.



ATTENTION

At times, it may be difficult to maintain optimum reception because the antenna affixed to your vehicle is in motion constantly (relative to the broadcast antenna), encountering continuous variation in the received radio signals' strength. Other factors affecting reception include interference from natural obstacles, sign posts, etc.

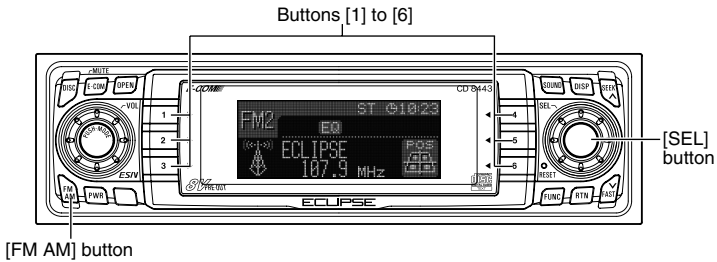

Entering stations into memory automatically (The automatic preset mode: ASM)

- 1** Press the [FM AM] button to switch to the desired FM or AM bands.

Radio bands will switch from FM1 → FM2 → FM3 → AM in order each time the button is pressed.

- 2** Press the [SEL] button for more than one second until a beep is heard.

The automatic preset mode starts.

The [ASM ON] indicator on the screen flashes, and stations are automatically entered in memory under buttons [1] to [6].

These buttons are called preset buttons.



- Press any numbered button to select the station whose frequency is indicated right above the button.
- When a new station is set in memory, the station previously set in memory will be deleted.
- If there are fewer than six receivable stations, the stations set in the remaining buttons will be retained.

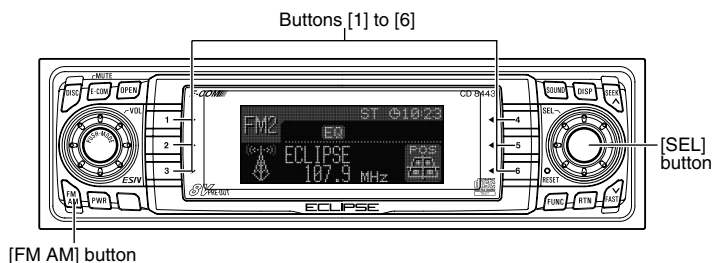

Manually setting stations into memory

This section covers the setting of stations in memory under the numbered buttons.

- 1** Press the [FM AM] button to switch between FM and AM.
- 2** Turn the [SEL] button to the right or left to tune to the station to be entered in memory.
- 3** Select any button, from [1] to [6], and press it for more than two seconds.

The tuned station is now memorized and set in the button selected. Repeat the procedure to set additional manually tuned stations in memory, in turn, for buttons [1] to [6]. These buttons are called the preset buttons.



Caution

If the vehicle's battery is disconnected (for repairs to the vehicle or for removing the receiver), all stations in memory will be lost. In such a case, set stations in memory again.

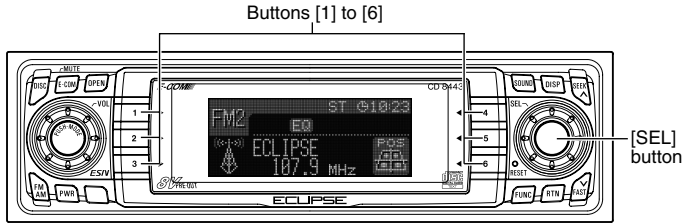

Preset station scan

This function enables reception of all the stations in the preset buttons for five seconds each.

- 1** Press the [SEL] button for less than one second.

[P SCAN] will appear at the display, and stations stored under preset buttons [1] through [6] will be played for five seconds each.

- 2** To stop the preset scan mode at a desired station, press the [SEL] button again.

The receiver will stay tuned to the desired station.

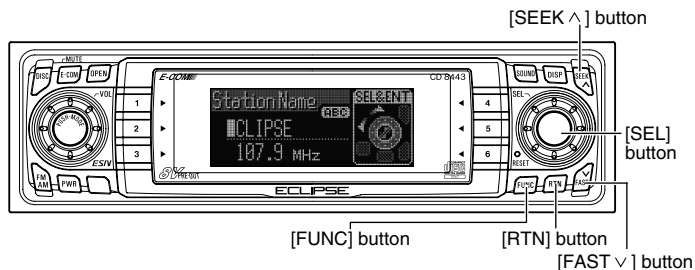

Setting a station name

Station name settings can be changed.

1 Press the [FUNC] button while in the tuner mode.

2 Turn the [SEL] button to select Station Name.

The selected item will be highlighted.

3 Press the [SEL] button.

The station name setting mode is activated.

4 Press the [SEEK ^] button to select the character type.

Pressing the button will switch types from [ABC] (alphabet characters) to [123] (numeric characters) and then [!&?] (symbols).

5 Press either [SEL] or [FAST v] button to select the position in which to enter the character.

The character will be inserted where the cursor is flashing:

[SEL] button: Moves the cursor to the right.

[FAST v] button: Advances the cursor to the left.

6 Turn the [SEL] button to the left or right to select characters.

Turn to the right: Advances the character forward in its type.
Turn to the left: Moves the character backward in its type.

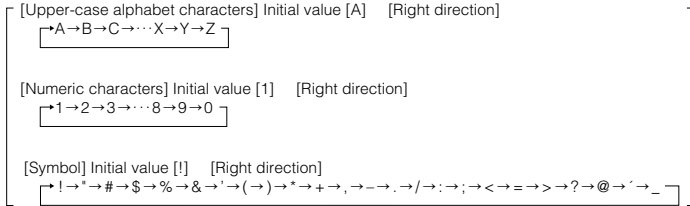

- To change the type of character to be entered, repeat steps 3 and 4.
- A maximum of 10 characters may be entered per station name.
- A maximum of 50 station names may be stored.

7 Press the [RTN] button.

At this time, other adjustments can also be made in function mode.

8 Press the [FUNC] button to exit function mode.

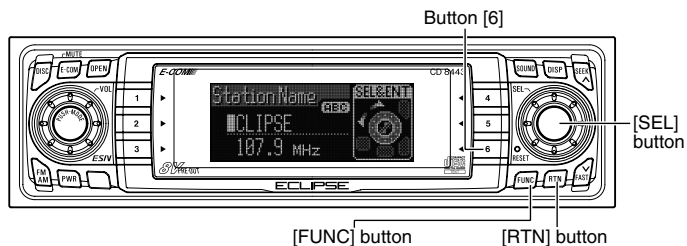

Deleting a station name

- 1** Press the [FUNC] button while in the tuner mode.
- 2** Turn the [SEL] button to select Station Name.
The selected item will be highlighted.
- 3** Press the [SEL] button.
The station name that is displayed at this point will be deleted.
- 4** Hold the [6] button down for more than two seconds.
The station name has now been deleted.
- 5** Press the [RTN] button.
At this time, other adjustments can also be made in function mode.
- 6** Press the [FUNC] button to exit function mode.

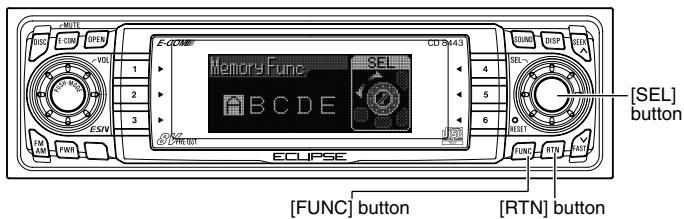

Changing the number of bands

The number of bands can be changed by changing the memory allocations. The number of bands is fixed for each pattern and the number of CD titles that can be set is also changed at the same time.

1 Press the [FUNC] button while in the disc mode.

2 Turn the [SEL] button to select Memory Func.

The selected item will be highlighted.

3 Press the [SEL] button.

The mode will change to memory allocation address selection mode.

4 Turn the [SEL] button to select an address from A to E.

The patterns switches between the following. The characters for the selected item are highlighted and the memory allocation address changes.

MEMORY A (standard)	AM/FM: 1/3, CD title memory: 30 titles
MEMORY B	AM/FM: 2/5, CD title memory: 40 titles
MEMORY C	AM/FM: 1/3, CD title memory: 60 titles
MEMORY D	AM/FM: 2/5, CD title memory: 80 titles
MEMORY E	AM/FM: 3/8, CD title memory: 100 titles

5 Press the [RTN] button.

At this time, other adjustments can also be made in function mode.

6 Press the [FUNC] button to exit function mode.

FM reception characteristics

In general, FM has much better tonal quality than AM. However, FM and FM stereo reception encounter several characteristic problems not encountered with AM. FM is more difficult to receive than AM in a moving vehicle. The following are explanatory notes on what to expect from FM reception and on how to get satisfactory performance.

FM RECEPTION DIFFERS FROM AM

A characteristic of transmitted signals is that lower frequencies travel further. FM frequencies are much higher than AM's (similar to a ray of light): they won't bend but they will reflect. Often, they will be interrupted by tall buildings, mountains, etc., taking direct and indirect paths to your vehicle's antenna. The distance at which FM stations can be received satisfactorily is usually not nearly as far as that which AM stations can be received.

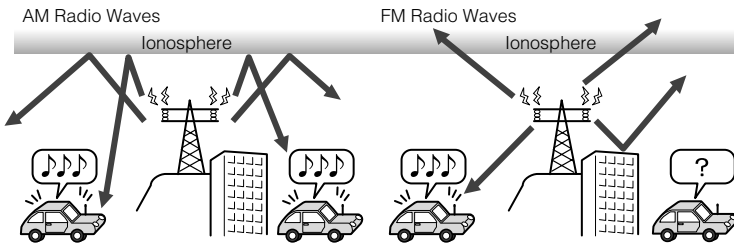

FADING OUT

In weak signal or “fringe” reception areas, FM stations may fade out completely, or fade in and out. When driving in weak signal areas, such as near hills, through valleys or tunnels, among tall buildings, etc., you may encounter unusual noise interference. THIS IS NOT A TUNER PROBLEM. In this case, you can only wait until you are in a better reception area, tune to a stronger station, or reduce the treble level.

RECEPTION AREA OF FM BROADCASTS

A home receiver can catch weak FM stereo signals through the use of a tall, directional or ultra-sensitive antenna. In a moving vehicle, the area for good reception is limited because of varying conditions encountered while driving, including the types and heights of broadcast antenna structures, signal strength, engine noise, etc. For best reception with manual antenna, extend the antenna mast as far as possible.

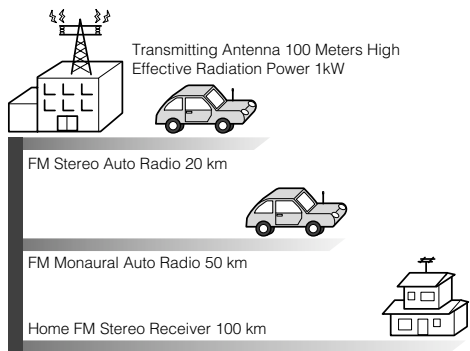

Reception quality varies depending on the power of the FM station, natural and artificial barriers, weather conditions, etc.

MULTIPATH

The reflection characteristics of FM waves cause another problem called multipath—FM wave signals reflecting off of buildings, mountains, etc. When the antenna receives direct and reflected waves at the same time, distortion of sound in the treble range often occurs, such as static or harsh-sounding voices. THIS IS NOT A TUNER PROBLEM. Only moving to another area with a clearer signal path can remedy the situation.

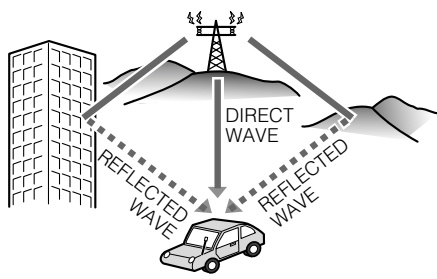

How to operate the Sound Adjustment Mode

About Sound Adjustment Mode

This unit is equipped with two different sound adjustment modes: normal mode and pro mode.

In normal mode, the acoustic characteristics inside the vehicle can be adjusted using comparatively simple settings. In addition, it corresponds to basic sound systems which comprise front speakers, rear speakers and an added sub-woofer if necessary.

In pro mode, the sound quality characteristics can be adjusted item by item using more sophisticated settings than in normal mode. In addition, the adjustments can be made to suit 3-way speaker system where the front speaker, rear speaker and non-fader output can be set to Hi (treble range) Mid (medium range) or Low (bass range). Refer to the table below and to the operations for each mode for details of each mode.

The following adjustments can be made in normal mode and pro mode respectively.

	Normal mode	Pro mode
Graphic equalizer	○ (See page 74)	×
Parametric equalizer	○ (single-band *1) (See page 77)	○ (See page 87)
Time alignment	○ (Simplified) (See page 79)	○ (See page 92)
Crossover	○ (See page 84)	○ (See page 94)
MP3 harmonizer *2	×	○ (See page 96)
Non-fader phase	○ (See page 85)	○ (See page 97)
BASS/TREBLE *3	×	○

*1: In normal mode, the parametric equalizer is adjusted during EQ mode.

*2: Only when E-COM is connected.

*3: Adjusted during audio control mode (see page 24).

GRAPHIC EQUALIZER

The graphic equalizer lets you select from six preset equalizer modes in accordance with the genre and instruments of the music being played, and also lets you make fine adjustments within each mode.

PARAMETRIC EQUALIZER

A variety of materials are used inside a vehicle to manufacture the seats and windows, and because these materials absorb and reflect sound in different ways, the parametric equalizer lets you adjust the peaks and dips of the frequency characteristics inside the vehicle to compensate for this.

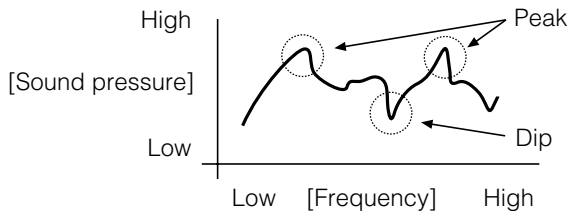

An "equalizer" is a function that corrects these peaks and dips in order to flatten the frequency characteristics. However with a normal graphic equalizer, the median frequency and the Q (sharpness and band width) are fixed, so that when neighboring bands are corrected, there is a limit to the amount by which distortion in the peak and dip characteristics can be corrected.

A "parametric equalizer" lets you adjust the median frequency, Q (sharpness and band width) and gain to variable levels, so that you can make fine adjustments to spot areas of the frequency band.

[Parametric equalizer characteristics]

- ①. Median frequency can be varied.

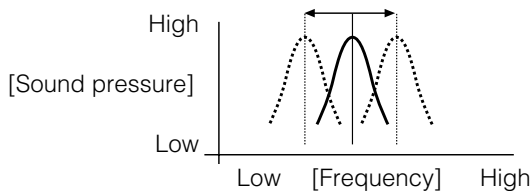

- ②. Gain can be varied.

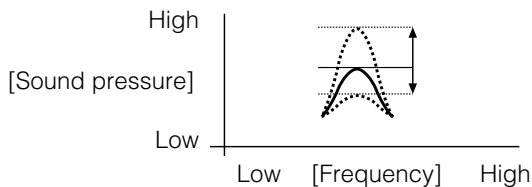

- ③. Q (sharpness/band width) can be varied.

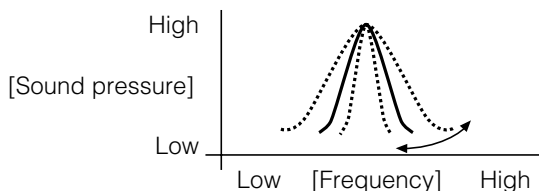

When this unit is in normal mode, a single parametric equalizer function is available in addition to the 13-band graphic equalizer, so that points that cannot be adjusted using the graphic equalizer can be corrected using the single-band parametric equalizer.

In addition, in pro mode, the parametric equalizer can be used to adjust five bands in the treble to medium range, and five bands in the medium to bass range.

TIME ALIGNMENT

With vehicle audio systems, the installation position of the speakers and the position of the listener mean that the distances from the listener to the left and right speakers are almost always different. These differences in the distance from the listener to each speaker in turn means that the time taken for the sound to reach the listener is different for each speaker. The result of this is that the phases of each speaker (biases) become mismatched and the sound becomes unnatural, as though the sound stage is not wide enough.

The "time alignment" function corrects the time taken for the sound waves to reach the listener in order to set the optimum phase for the listening position so that the sound becomes more expansive as though it is being listened to on a sound stage.

The basic adjustment method involves measuring the actual distances to each speaker and calculating the differences in distance relative to the most distant speaker in order to derive the delay time for the sound from each speaker.

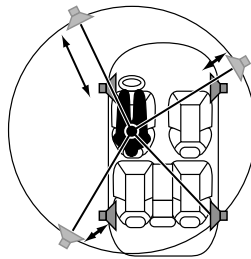

When this unit is in normal mode, a simplified time alignment function is available. You can use this function to adjust only four parameters (position selector, vehicle type, tweeter settings and rear speaker position settings), and so you can make basic time alignment settings without measuring the actual distances to each speaker. In addition, in pro mode you can adjust the time delays and levels for each individual speaker based on the actual speaker layout.

CROSSOVER

The frequency band that is stored by audio media such as CDs is a fairly wide range from 20 Hz to 20 kHz, and it is difficult for a single speaker to be able to play back all frequencies in such a wide range.

Because of this, several speakers can be used, with different frequency bands (such as treble, medium and bass) allotted to each speaker so that wide frequency ranges can be played back.

The "Crossover" function is used to allot the frequency ranges that are to be played back by each speaker in accordance with the installed speaker units and the layout of the speakers, in order to obtain the maximum level of performance from the speakers and to provide the most stable frequency characteristics.

The crossover function includes a high-pass filter (HPF) for playing back treble sounds, and a low-pass filter (LPF) for playing back bass sounds. In addition, the HPF and LPF are used in combination in order to play back sounds in the medium range.

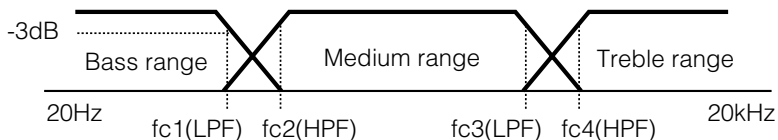

fc^* : Cutoff frequency

For example, when adjusting the HPF, frequencies that are lower than the specified frequency are progressively dampened, rather than simply not being played back at all. The "slope" adjustment function is the function that is used to adjust these dampening characteristics.

The slope characteristics of a filter are such that with larger slope values (for example 12 dB/oct), the slope becomes steeper, and so the amount of sound mixing in with neighboring bands becomes less so that only the target band is played back. However, it also causes the merging of sound between speakers to become poorer and can result in greater distortion.

- The crossover function is a filter that allocates specified frequency bands.
- A high-pass filter (HPF) is a filter that cuts out frequencies that are lower than the specified frequency (bass range) and allows higher frequencies (treble range) to pass through.
- A low-pass filter (LPF) is a filter that cuts out frequencies that are higher than the specified frequency (treble range) and allows lower frequencies (bass range) to pass through.
- The slope is the signal level at which frequencies that are one octave higher or one octave lower are dampened. The larger the slope value, the greater is the slope. In addition, when "PASS" is selected, the slope is eliminated (sound does not pass through the filters), so that the crossover function has no effect.

When this unit is in normal mode, it corresponds to basic speaker systems which comprise front speakers, rear speakers and an added sub-woofer if necessary. In such cases, the crossover can be used to apply the HPF to the front and rear speakers and the LPF to the sub-woofer so that the sound from all speakers merges properly.

In addition, in pro mode, the adjustments can be made to suit speaker system where the front speaker, rear speaker and non-fader output can be switched between Hi, Mid or Low output and the speakers can be combined according to each range (treble range: tweeter, medium range: Mid, bass range: woofer) to provide 3-way playback. In this case, the crossover function can be used to adjust the playback ranges so that the HPF is applied to the treble-range speakers, the HPF and LPF is applied to the medium-range speakers, and the LPF is applied to the bass-range speakers so that the sound from all speakers merges properly.

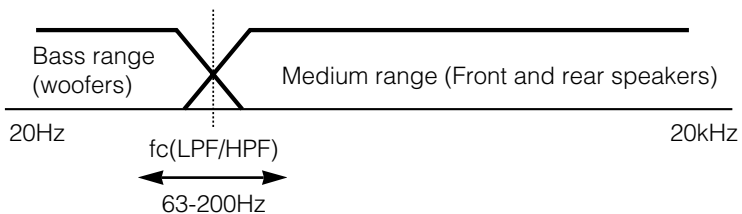

MP3 HARMONIZER

When original sounds are converted to MP3 format, frequency ranges that are not normally audible to the human ear are compressed. The MP3 harmonizer can be used to play back these compressed sounds at as close to their original form as possible so that clear and powerful sound can be enjoyed.

NON-FADER PHASE

The sounds that are output from woofers include sounds that are in the same frequency ranges that are output from the front and rear speakers, and under the various conditions that can occur inside vehicle compartments, some of these sounds may cancel each other out. This phenomenon can be eliminated by changing the phase of the woofer.

The phase of the woofer can be set to normal timing (in which the output timing between the front and rear speakers and the woofer is the same) or reverse timing (in which the output timing between the front and rear speakers and the woofer is different), depending on the vehicle compartment conditions.

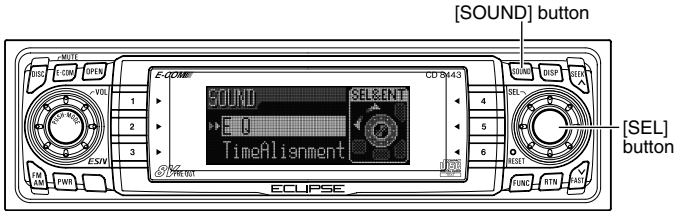

Operations during Normal Mode

- 1 Press the [SOUND] button for less than one second.

The mode will change to sound adjustment mode.

- 2 Press the [SOUND] button for more than two seconds.

The mode switches between normal mode and pro mode each time the button is pressed. During normal mode, "PRO MODE OFF" and the scroll display appear in the display.



If you press the [SOUND] button during sound adjustment mode, the adjustment mode is canceled and the mode returns to normal music mode.

- 3 Turn the [SEL] button to select a setting item.

When the button is turned, the setting item changes in the following order and the selected item is highlighted.

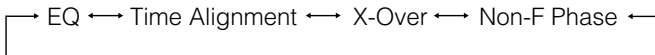

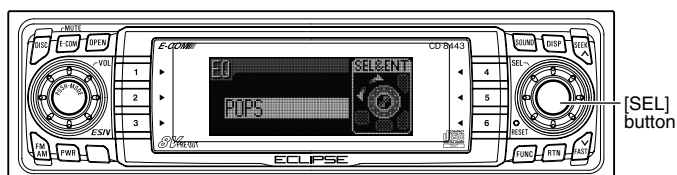

EQUALIZER ADJUSTMENT (EQ)

EQ (equalizer) mode can be used to adjust the frequency of the audio channels being played back in accordance with the genre and instruments of the music being played. In addition, correction of the frequency characteristics inside the vehicle is also possible using the 13-band graphic equalizer and the single-band parametric equalizer.

Switching equalizer modes

The equalizer mode can be selected as follows.

1 Turn the [SEL] button to select EQ.

The selected item will be highlighted.

2 Press the [SEL] button.

The mode will change to equalizer adjustment mode.

3 Press the [SEL] button for less than one second.

Each time the button is pressed, the setting item changes in the following order and the selected item is highlighted.

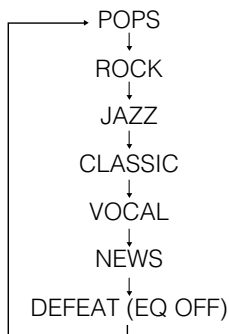

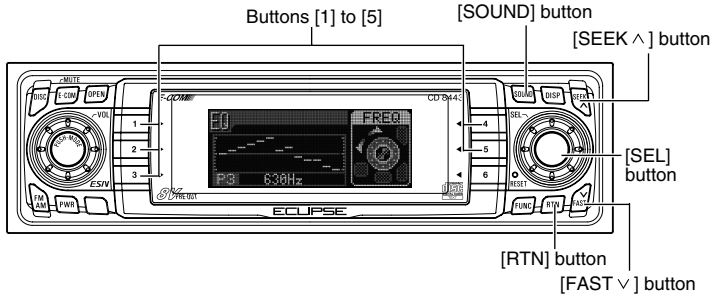

4 Press the [RTN] button.

At this time, other adjustments can also be made in normal mode.

5 Press the [SOUND] button for less than one second to exit sound adjustment mode.



The initial EQ settings are factory preset.

Fine-tuning EQ functions

Fine adjustments can be made in each equalizer mode.

1 Select the equalizer mode.

Refer to the section "Switching equalizer modes" on page 74.

2 Turn the [SEL] button to select the frequency to be adjusted.

When the button is turned, the frequency changes in the following order.

63Hz ↔ 100Hz ↔ 160Hz ↔ 250Hz ↔ 400Hz ↔ 630Hz ↔ 1kHz ↔ 1.6kHz ↔ 2.5kHz ↔ 4kHz ↔ 6.3kHz ↔ 10kHz ↔ 16kHz

3 Press the [SEEK ^ /FAST v] button.

This adjusts the frequency level.

[SEEK ^] button: Increases level.

[FAST v] button: Decreases level.

4 Hold down a button, [1] to [5], for more than two seconds to preset a value.

The preset value is overwritten by the value set using the above steps.

5 Press the [RTN] button.

At this time, other adjustments can also be made in normal mode.

6 Press the [SOUND] button for less than one second to exit sound adjustment mode.

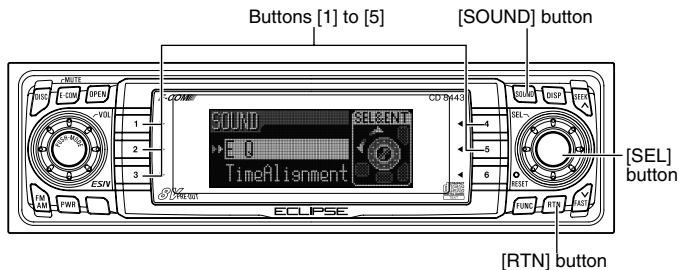

Selecting an equalizer mode from memory

Press a preset button to select the equalizer mode set in memory for the button. The buttons that set equalizer modes in memory are called preset buttons.

- 1 Turn the [SEL] button to select EQ.**
- 2 Press the [SEL] button.**
- 3 Select any button, from [1] to [5], and press it for less than two seconds.**
The preset pattern stored in memory will be retrieved.
- 4 Press the [RTN] button.**
At this time, other adjustments can also be made in normal mode.
- 5 Press the [SOUND] button for less than one second to exit sound adjustment mode.**



When the preset value is changed, the display shows as follows:

P ○
↑ 1~5 (Preset ch No.)

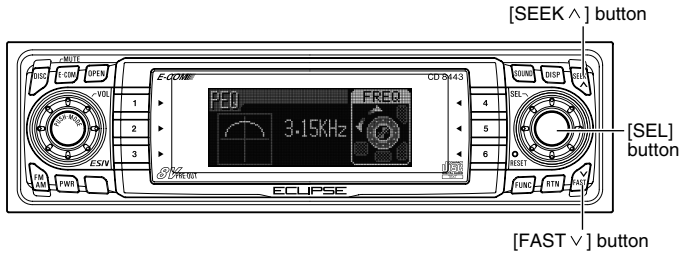

Making fine adjustments to the parametric equalizer

You can select and adjust frequencies using the parametric equalizer (single-band).



When the following operations are carried out, the parametric equalizer settings that have been made previously will be changed.

- 1 Turn the [SEL] button to select EQ and press the [SEL] button.**
- 2 Press the [SEL] button for more than one second.**
The mode will change to parametric equalizer adjustment mode.
- 3 Turn the [SEL] button to select the frequency for changing the parametric equalizer settings.**
When the button is turned, the frequency changes in the following order.
80Hz ↔ 125Hz ↔ 200Hz ↔ 315Hz ↔ 500Hz ↔ 800Hz ↔ 1.25kHz ↔ 2kHz ↔ 3.15kHz ↔ 5kHz ↔ 8kHz ↔ 12.5kHz
- 4 Press the [SEEK ^ / FAST v] button.**
This adjusts the frequency level.
[SEEK ^] button: Increases level.
[FAST v] button: Decreases level.

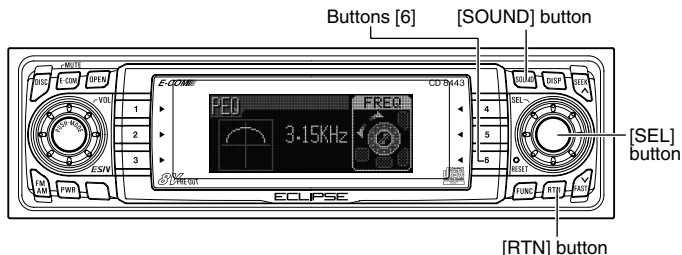

5 Press the [6] button to select the Q curve pattern.

Each time the button is pressed, the Q curve changes in the following order.

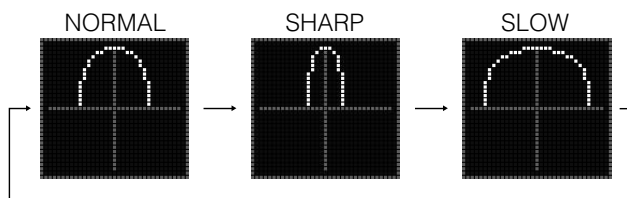

6 Press the [SEL] button for more than one second.

The mode will return to equalizer setting mode.

7 Press the [RTN] button.

At this time, other adjustments can also be made in normal mode.

8 Press the [SOUND] button for less than one second to exit sound adjustment mode.

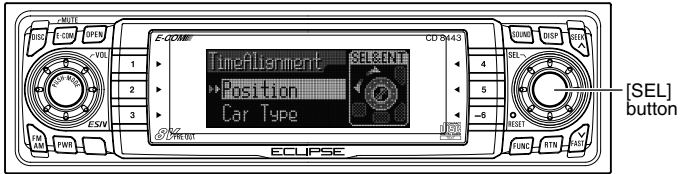

SIMPLIFIED TIME ALIGNMENT SETTINGS (Time Alignment)

This function corrects the position characteristics and frequency characteristics in order to delay the signals being output from the various speakers so that the signals from each speaker reach the listening position at the same time.

1 Turn the [SEL] button to select Time Alignment.

The selected item will be highlighted.

2 Press the [SEL] button.

The mode will change to time alignment setting mode.

3 Turn the [SEL] button to select a setting item.

When the button is turned, the setting item changes in the following order and the selected item is highlighted.

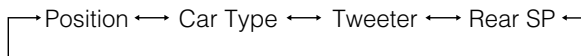

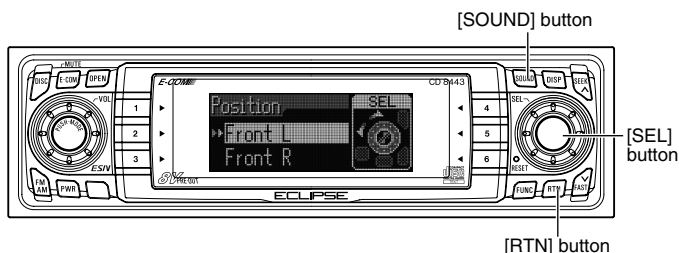

Position selector setting (Position)

When the position of the listener's seat is selected, the time taken for the sound to travel from the speakers to the listener can then be adjusted in order to obtain a more natural sound orientation. This unit allows up to four different positions to be set.

1 Turn the [SEL] button to select Position.

The selected item will be highlighted.

2 Press the [SEL] button.

The mode will change to position selector setting mode.

3 Turn the [SEL] button to select the setting item.

When the button is turned, the setting item changes in the following order and the selected item is highlighted.



4 Press the [RTN] button.

Other time alignment items can be set at this time.

5 Press the [RTN] button.

At this time, other adjustments can also be made in normal mode.

6 Press the [SOUND] button for less than one second to exit sound adjustment mode.



If the position selector has been set (to a setting other than OFF), the BAL (balance) and FAD (fader) settings will be canceled.

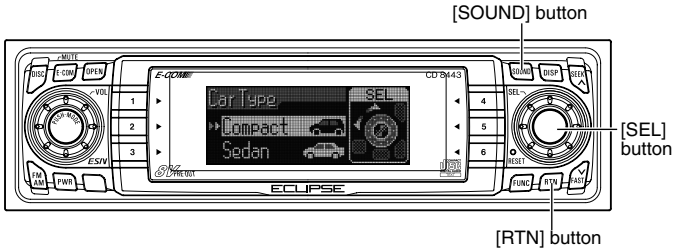

Selecting the type of vehicle (Car Type)

You can select the time alignment settings to match your vehicle from a range of preset settings for different types of vehicle, allowing you to select the optimum time alignment settings automatically.

1 Turn the [SEL] button to select Car Type.

The selected item will be highlighted.

2 Press the [SEL] button.

The mode will change to car type selection mode.

3 Turn the [SEL] button to select the setting item.

When the button is turned, the setting item changes in the following order and the selected item is highlighted.

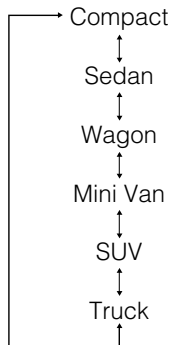

4 Press the [RTN] button.

Other time alignment items can be set at this time.

5 Press the [RTN] button.

At this time, other adjustments can also be made in normal mode.

6 Press the [SOUND] button for less than one second to exit sound adjustment mode.

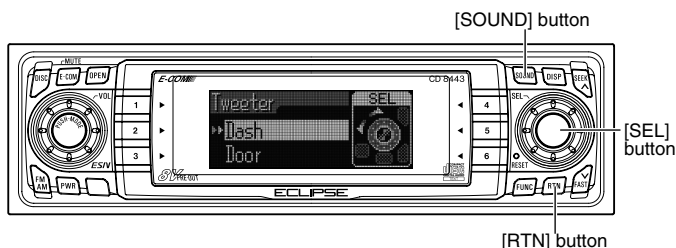

Tweeter settings (Tweeter)

You can select the tweeter installation location and whether or not a tweeter is being used or not, allowing you to select the optimum time alignment settings automatically.

1 Turn the [SEL] button to select Tweeter.

The selected item will be highlighted.

2 Press the [SEL] button.

The mode will change to tweeter setting mode.

3 Turn the [SEL] button to select the setting item.

When the button is turned, the setting item changes in the following order and the selected item is highlighted.



4 Press the [RTN] button.

Other time alignment items can be set at this time.

5 Press the [RTN] button.

At this time, other adjustments can also be made in normal mode.

6 Press the [SOUND] button for less than one second to exit sound adjustment mode.



If the front speakers have been installed to the dash panel, you can set the tweeter setting to "Dash" even if no tweeter has been installed.

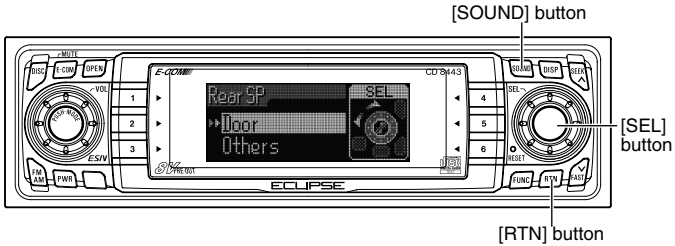

Rear speaker position selection (Rear SP)

You can select the rear speaker installation location, allowing you to select the optimum time alignment settings automatically.

- 1 Turn the [SEL] button to select Rear SP.**
The selected item will be highlighted.
- 2 Press the [SEL] button.**
The mode will change to rear speaker position setting mode.
- 3 Turn the [SEL] button to select the setting item.**
When the button is turned, the setting item changes in the following order and the selected item is highlighted.

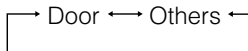

- 4 Press the [RTN] button.**
Other time alignment items can be set at this time.
- 5 Press the [RTN] button.**
At this time, other adjustments can also be made in normal mode.
- 6 Press the [SOUND] button for less than one second to exit sound adjustment mode.**

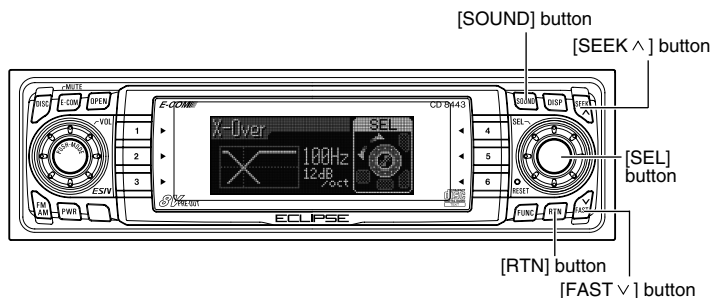

CROSSOVER ADJUSTMENT (X-Over)

The frequencies for the front and rear speaker high-pass filter (HPF) and woofer low-pass filter (LPF) can be set within a range of 63 to 200 Hz. (This is the same as the HPF and LPF cutoff frequencies.)

1 Turn the [SEL] button to select X-Over.

The selected item will be highlighted.

2 Press the [SEL] button.

The mode will change to crossover setting mode.

3 Turn the [SEL] button to select the cut-off frequency.

When the button is turned, the frequency changes in the following order.

63Hz ↔ 80Hz ↔ 100Hz ↔ 125Hz ↔ 160Hz ↔ 200Hz ↔

4 Press the [SEEK ^ /FAST v] buttons to set the slope.

[SEEK ^] button: PASS

[FAST v] button: 12dB/oct



ATTENTION

If no woofer has been connected, set the slope adjustment to "PASS". (If you set the slope to 12 dB/oct, the bass sound will not be output from the speakers.)

5 Press the [RTN] button.

At this time, other adjustments can also be made in normal mode.

6 Press the [SOUND] button for less than one second to exit sound adjustment mode.

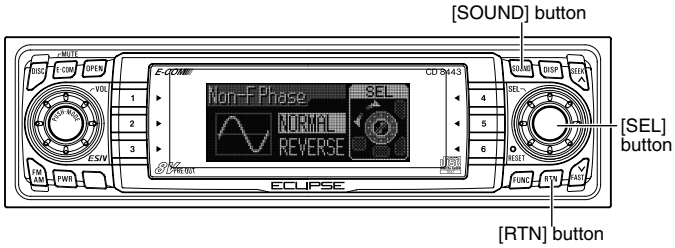

NON-FADER PHASE SELECTION (NON-F Phase)

The merging of sound between the front and rear speakers and the woofer can be improved by selecting the phase. Switch the phase to a phase which lets the speakers combine without any disharmony.

- 1 Turn the [SEL] button to select Non-F Phase.**
The selected item will be highlighted.
- 2 Press the [SEL] button.**
The mode will change to phase selection mode.
- 3 Turn the [SEL] button to select NORMAL or REVERSE.**
NORMAL: Normal phase
REVERSE: Reverse phase
- 4 Press the [RTN] button.**
At this time, other adjustments can also be made in normal mode.
- 5 Press the [SOUND] button for less than one second to exit sound adjustment mode.**

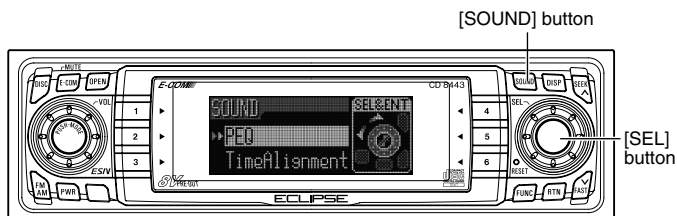

Operations during Pro Mode

- 1 Press the [SOUND] button for less than one second.

The mode will switch to sound adjustment mode.

- 2 Press the [SOUND] button for more than two seconds.

The mode switches between normal mode and pro mode each time the button is pressed. During pro mode, "PRO MODE ON" and the scroll display appear in the display.



ATTENTION

- If the vehicle is equipped with a 3-way speaker system, do not change from pro mode to normal mode. Doing so may cause damage to the speakers.
- If you press the [SOUND] button during sound adjustment mode, the adjustment mode is canceled and the mode returns to normal music mode.

- 3 Turn the [SEL] button to select a setting item.

When the button is turned, the setting item changes in the following order and the selected item is highlighted.

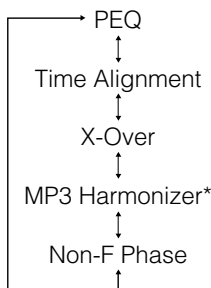

*: This is displayed only if E-COM is connected.

PARAMETRIC EQUALIZER ADJUSTMENT (PEQ)

Mid-Band (Group-1) Parametric adjustment in 5-Bands of 25 Frequencies.

Hi-Band (Group-2) Parametric adjustment in 5-Bands of 20 Frequencies.

Eclipse has by default assigned arbitrary frequencies for each of the 5-Bands (Hi/Mid for 10 parametric bands total).



Frequencies in each group (Mid-Group or Hi-Group) cannot be duplicated (repeated).

Release a frequency from its location, before it can be re-assignment (available again for use in another band).

Example: If you want the Hi-Group H-1 location to have a parametric frequency of 1.25kHz.

Because this frequency is in use by M-5 you must first assign M5 a new frequency, this will release the band for use in the Hi-Group H1 at 1.25kHz.

Mid Group

M 1	63 Hz	80 Hz	100 Hz	125 Hz	160 Hz	200 Hz	250 Hz	315 Hz	400 Hz	500 Hz	630 Hz	800 Hz	1.0k Hz	1.25k Hz	1.6k Hz	2.0k Hz	2.5k Hz	3.15k Hz	4.0k Hz	5.0k Hz	6.3k Hz	8.0k Hz	10k Hz	12.5k Hz	16k Hz
M 2	63 Hz	80 Hz	100 Hz	125 Hz	160 Hz	200 Hz	250 Hz	315 Hz	400 Hz	500 Hz	630 Hz	800 Hz	1.0k Hz	1.25k Hz	1.6k Hz	2.0k Hz	2.5k Hz	3.15k Hz	4.0k Hz	5.0k Hz	6.3k Hz	8.0k Hz	10k Hz	12.5k Hz	16k Hz
M 3	63 Hz	80 Hz	100 Hz	125 Hz	160 Hz	200 Hz	250 Hz	315 Hz	400 Hz	500 Hz	630 Hz	800 Hz	1.0k Hz	1.25k Hz	1.6k Hz	2.0k Hz	2.5k Hz	3.15k Hz	4.0k Hz	5.0k Hz	6.3k Hz	8.0k Hz	10k Hz	12.5k Hz	16k Hz
M 4	63 Hz	80 Hz	100 Hz	125 Hz	160 Hz	200 Hz	250 Hz	315 Hz	400 Hz	500 Hz	630 Hz	800 Hz	1.0k Hz	1.25k Hz	1.6k Hz	2.0k Hz	2.5k Hz	3.15k Hz	4.0k Hz	5.0k Hz	6.3k Hz	8.0k Hz	10k Hz	12.5k Hz	16k Hz
M 5	63 Hz	80 Hz	100 Hz	125 Hz	160 Hz	200 Hz	250 Hz	315 Hz	400 Hz	500 Hz	630 Hz	800 Hz	1.0k Hz	1.25k Hz	1.6k Hz	2.0k Hz	2.5k Hz	3.15k Hz	4.0k Hz	5.0k Hz	6.3k Hz	8.0k Hz	10k Hz	12.5k Hz	16k Hz

H 1	200 Hz	250 Hz	315 Hz	400 Hz	500 Hz	630 Hz	800 Hz	1.0k Hz	1.25k Hz	1.6k Hz	2.0k Hz	2.5k Hz	3.15k Hz	4.0k Hz	5.0k Hz	6.3k Hz	8.0k Hz	10k Hz	12.5k Hz	16k Hz
H 2	200 Hz	250 Hz	315 Hz	400 Hz	500 Hz	630 Hz	800 Hz	1.0k Hz	1.25k Hz	1.6k Hz	2.0k Hz	2.5k Hz	3.15k Hz	4.0k Hz	5.0k Hz	6.3k Hz	8.0k Hz	10k Hz	12.5k Hz	16k Hz
H 3	200 Hz	250 Hz	315 Hz	400 Hz	500 Hz	630 Hz	800 Hz	1.0k Hz	1.25k Hz	1.6k Hz	2.0k Hz	2.5k Hz	3.15k Hz	4.0k Hz	5.0k Hz	6.3k Hz	8.0k Hz	10k Hz	12.5k Hz	16k Hz
H 4	200 Hz	250 Hz	315 Hz	400 Hz	500 Hz	630 Hz	800 Hz	1.0k Hz	1.25k Hz	1.6k Hz	2.0k Hz	2.5k Hz	3.15k Hz	4.0k Hz	5.0k Hz	6.3k Hz	8.0k Hz	10k Hz	12.5k Hz	16k Hz
H 5	200 Hz	250 Hz	315 Hz	400 Hz	500 Hz	630 Hz	800 Hz	1.0k Hz	1.25k Hz	1.6k Hz	2.0k Hz	2.5k Hz	3.15k Hz	4.0k Hz	5.0k Hz	6.3k Hz	8.0k Hz	10k Hz	12.5k Hz	16k Hz

Hi-Group

There are 10 Mid & Hi-Frequency locations (5 + 5) available for the parametric equalizer.

The Parametric Equalizer is divided into two groups Mid & Hi. Any frequency assigned is highlighted in White, and is unavailable for use elsewhere.

Bands selected are grayed out in the diagram to show how they are in use and otherwise unavailable for reuse.

Bands in black are unused (available) and can be assigned to within their respective bands (Mid or Hi parametric locations).

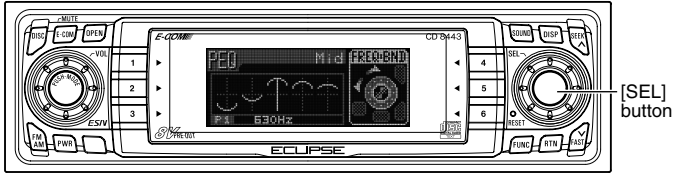

1 Turn the [SEL] button to select PEQ.

The selected item will be highlighted.

2 Press the [SEL] button.

The mode will change to parametric equalizer adjustment mode.

3 Press the [SEL] button for less than one second to select the channel and band to be adjusted.

Each time the button is pressed, the selection changes in the following order.

Hi1 → Hi2 → Hi3 → Hi4 → Hi5 → Mid1 → Mid2 → Mid3 → Mid4 → Mid5 →

4 Turn the [SEL] button to select the frequency to be adjusted.

When the button is turned, the frequency changes in the following order.

Hi: 200Hz ↔ 250Hz ↔ 315Hz ↔ 400Hz ↔ 500Hz ↔ 630Hz ↔ 800Hz ↔ 1kHz ↔ 1.25kHz ↔ 1.6kHz ↔ 2kHz ↔ 2.5kHz ↔ 3.15kHz ↔ 4kHz ↔ 5kHz ↔ 6.3kHz ↔ 8kHz ↔ 10kHz ↔ 12.5kHz ↔ 16kHz

Mid: 63Hz ↔ 80Hz ↔ 100Hz ↔ 125Hz ↔ 160Hz ↔ 200Hz ↔ 250Hz ↔ 315Hz ↔ 400Hz ↔ 500Hz ↔ 630Hz ↔ 800Hz ↔ 1kHz ↔ 1.25kHz ↔ 1.6kHz ↔ 2kHz ↔ 2.5kHz ↔ 3.15kHz ↔ 4kHz ↔ 5kHz ↔ 6.3kHz ↔ 8kHz ↔ 10kHz ↔ 12.5kHz ↔ 16kHz

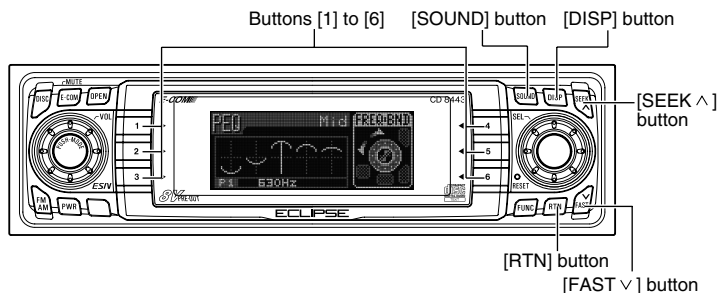

5 Press the [SEEK ^ /FAST v] button.

This adjusts the frequency level.

[SEEK ^] button: Increases level.

[FAST v] button: Decreases level.

6 Press the [6] button to select the Q curve pattern.

Each time the button is pressed, the Q curve changes in the following order.

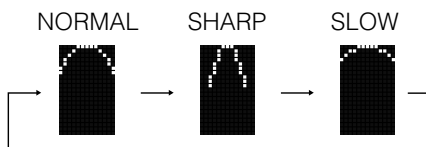

7 Repeat the operations in steps 3 to 6 to change the settings for each channel and band.

The frequencies that have been adjusted for either the channel or band cannot be selected.

8 Hold down a button, [1] to [5], for more than two seconds to preset a value.

The preset value is overwritten by the value set using the above steps.

The time alignment and crossover adjustments will also be stored at this time.

9 Press the [RTN] button.

At this time, other adjustments can also be made in pro mode.

10 Press the [SOUND] button for less than one second to exit sound adjustment mode.



When updating software, press the [DISP] button to measure and display the frequency characteristics.

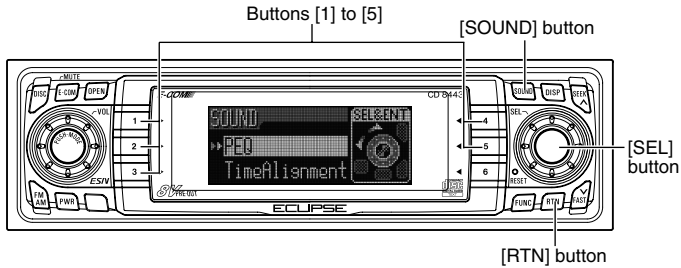

Selecting an equalizer mode from memory

Press a preset button to select the equalizer mode set in memory for the button. The buttons that set equalizer modes in memory are called preset buttons.

- 1 Turn the [SEL] button to select PEQ.**
- 2 Press the [SEL] button.**
- 3 Select any button, from [1] to [5], and press it for less than two seconds.**
The preset pattern stored in memory will be retrieved.
- 4 Press the [RTN] button.**
At this time, other adjustments can also be made in pro mode.
- 5 Press the [SOUND] button for less than one second to exit sound adjustment mode.**



When the preset value is changed, the display shows as follows:

P ○
↑ 1~5 (Preset ch No.)

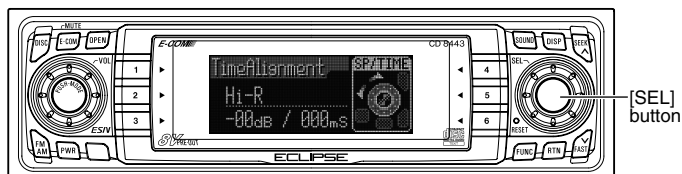

TIME ALIGNMENT ADJUSTMENT (Time Alignment)

The delay time and level of the sound from each speaker can be adjusted in order to correct any phase mismatches in the sound resulting from the listening position.

1 Turn the [SEL] button to select Time Alignment.

The selected item will be highlighted.

2 Press the [SEL] button.

The mode will change to time alignment adjustment mode.

3 Press the [SEL] button for less than one second to select the speaker band to be adjusted.

Each time the button is pressed, the selection changes in the following order.

Hi-L → Hi-R → Mid-L → Mid-R → Low-L → Low-R →

4 Turn the [SEL] button to select the speaker that is furthest away, and then adjust the delay time for the sound to arrive.

The delay time can be adjusted within 0.0 to 5.0 ms (in units of 0.1 ms).

Turn to the right: Increases the time.

Turn to the left: Decreases the time.

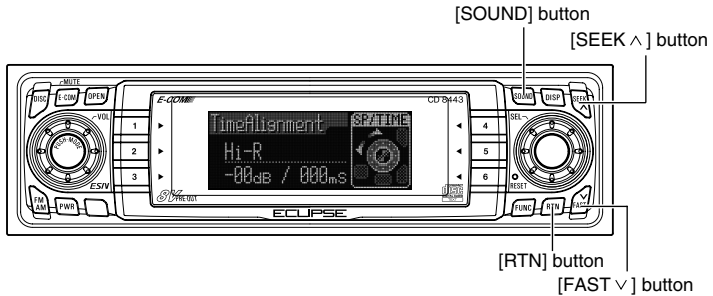

Refer to the following for the method of calculating the delay time.

$$A = (B - C) / 34$$

A: Delay time (ms)

B: Distance from listening position to furthest speaker (cm)

C: Distance from listening position to the speaker to be adjusted (cm)

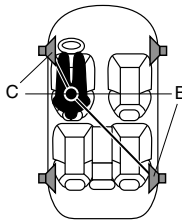

(Example) Listening position: Driver's seat (left)

B: 200 (cm)

C: 50 (cm)

Delay time = 200 (cm) - 50 (cm) / 34 = Approx. 4.4(ms)

5 Press the [SEEK ^ / FAST v] button.

Adjust the level for each speaker.

[SEEK ^] button: Increases level.

[FAST v] button: Decreases level.

6 Repeat the operations in steps 3 to 5 to change the settings for each speaker.

7 Press the [RTN] button.

At this time, other adjustments can also be made in pro mode.

8 Press the [SOUND] button for less than one second to exit sound adjustment mode.

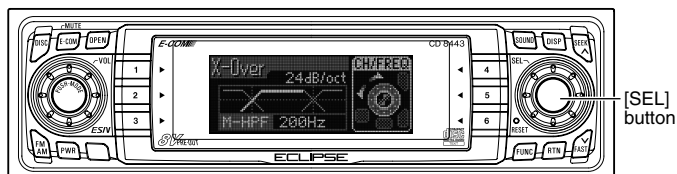

CROSSOVER ADJUSTMENT (X-Over)

This adjustment is for 3-way speaker system which uses different speakers for different ranges (treble range: tweeters, medium range: Mid, bass range: woofers). In this case, the crossover function applies the HPF to the treble-range speakers, it applies the HPF and LPF to the medium-range speakers, and it applies the LPF to the bass-range speakers to adjust the respective playback ranges so that the sounds from all speakers merge properly.

1 Turn the [SEL] button to select X-Over.

The selected item will be highlighted.

2 Press the [SEL] button.

The mode will change to crossover adjustment mode.

3 Press the [SEL] button to select the crossover adjustment channel.

Each time the button is pressed, the selection changes in the following order.

Hi → M-LPF → M-HPF → Low →

4 Turn the [SEL] button to select the cut-off frequency.

When the button is turned, the frequency changes in the following order.

Hi / M-LPF:

200Hz ↔ 250Hz ↔ 315Hz ↔ 400Hz ↔ 500Hz ↔ 630Hz ↔
 800Hz ↔ 1kHz ↔ 1.25kHz ↔ 1.6kHz ↔ 2kHz ↔ 2.5kHz ↔
 3.15kHz ↔ 4kHz ↔ 5kHz ↔ 6.3kHz ↔ 8kHz ↔ 10kHz

M-HPF / Low:

63Hz ↔ 80Hz ↔ 100Hz ↔ 125Hz ↔ 160Hz ↔ 200Hz

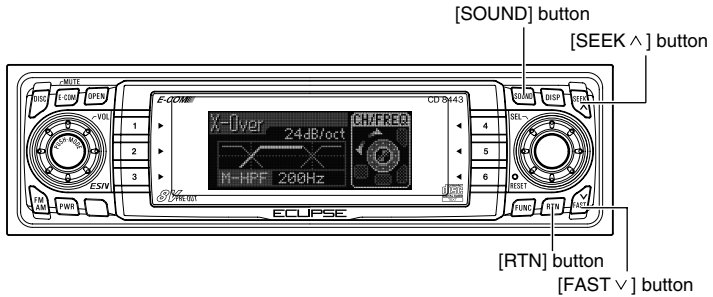

5 Press the [SEEK ^ /FAST v] buttons to set the slope.

[SEEK ^] button : The slope becomes more gentle.

[FAST v] button : The slope becomes steeper.

The slope can be set to "PASS", "6dB/oct", "12dB/oct", "18dB/oct" or "24dB/oct".

6 Repeat the operations in steps 3 to 5 to change the settings for each channel.

7 Press the [RTN] button.

At this time, other adjustments can also be made in pro mode.

8 Press the [SOUND] button for less than one second to exit sound adjustment mode.

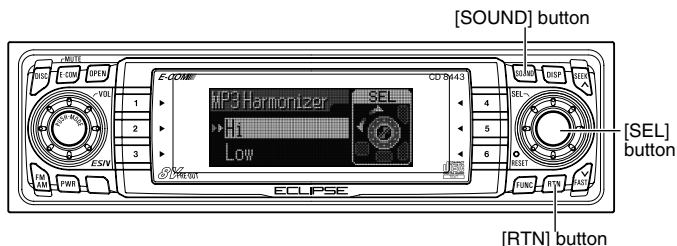

MP3 HARMONIZER SETTINGS (MP3 Harmonizer)

This function uses harmonic synthesis to restore the high-frequency component that is lost as a result of the compression process so that fresher sound can be obtained during MP3 playback.

- 1 Turn the [SEL] button to select MP3 Harmonizer.**
The selected item will be highlighted.
- 2 Press the [SEL] button.**
The mode will change to MP3 harmonizer setting mode.
- 3 Turn the [SEL] button to select the setting item.**
When the button is turned, the setting item changes in the following order and the selected item is highlighted.

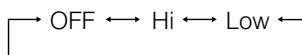

Hi: High effectiveness

Low: Low effectiveness

- 4 Press the [RTN] button.**
At this time, other adjustments can also be made in pro mode.
- 5 Press the [SOUND] button for less than one second to exit sound adjustment mode.**

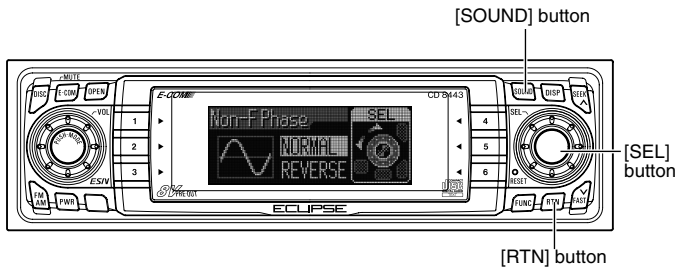

NON-FADER PHASE SELECTION (NON-F Phase)

The merging of sound between the front and rear speakers and the woofer can be improved by selecting the phase. Switch the phase to a phase which lets the speakers combine without any disharmony.

- 1 Turn the [SEL] button to select Non-F Phase.**
The selected item will be highlighted.
- 2 Press the [SEL] button.**
The mode will change to phase selection mode.
- 3 Turn the [SEL] button to select NORMAL or REVERSE.**
NORMAL: Normal phase
REVERSE: Reverse phase
- 4 Press the [RTN] button.**
At this time, other adjustments can also be made in pro mode.
- 5 Press the [SOUND] button for less than one second to exit sound adjustment mode.**

How to use the Card remote control

Precautions in use of the remote control

- Be careful when handling the control, especially because it is small and light. Dropping or striking it hard may damage it, wear out the battery or cause a malfunction.
- Keep the remote control free of moisture, dust and water. Do not subject it to shock.
- Do not place the remote control unit where it will get hot, such as on the dashboard or near a heater vent. Allowing the remote control unit to overheat may warp its case or cause other problems.
- Do not operate the remote control unit while driving because doing so could cause an accident.
- When using the remote control, point it directly at the remote control light receptor.
- The light receptor may not operate correctly if it is exposed to bright light such as direct sunlight.
- Be sure to press the [PWR] button on the main unit for more than two seconds to shut it down before leaving the car, or the car battery may be run down. When the main unit is shut down, the remote control will not work.
- Remove the batteries from the remote control unit whenever it is not to be used for a long time.

Cleaning the remote control

- Use a dry cloth to keep the unit clean. If the remote control unit gets extremely dirty, clean it with a cloth moistened in dilute liquid detergent. Do not use alcohol or thinner; these compounds may damage the finish.
- In no event should benzine or thinner be used. These substances will damage the case or finish.

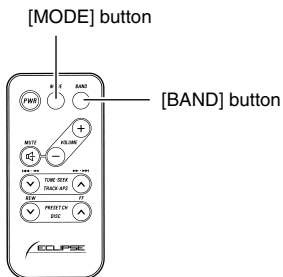

Switching playback modes

- 1 Press the [MODE] button.

Press the button to switch modes in the following sequence:



How to play the tuner

Select the tuner mode first.

Selecting the FM/AM band

- 1 Press the [BAND] button.

Each press will switch tuner modes from FM1 FM2
FM3 AM.

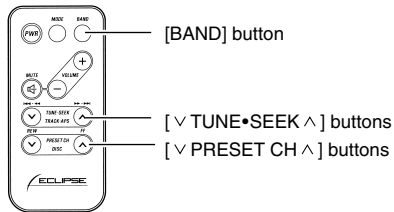

Selecting a station (manually or automatically)

A short press of the button will allow manual station tuning. Pressing for more than one second will start automatic tuning.

1 Press the [∨ TUNE•SEEK ∧] button.

[∧] button: Tunes to higher frequency stations.

[∨] button: Tunes to lower frequency stations.

Selecting preset stations

A total of six stations may be selected (preset tuning) out of those already set in memory through the main unit. (Refer to "Manually setting stations into memory," page 58.)

1 Press the [∨ PRESET CH ∧] button.

[∧] button: Select the next higher number preset button.

[∨] button: Select the next lower number preset button.

How to play CDs

Select the disc mode first.

Switching disc modes

1 Press the [BAND] button.

When one or two CD changers are connected, press the [BAND] button to change modes from CD player → CD changer 1 → CD changer 2.

The indicator will skip a changer or player that has no discs loaded.

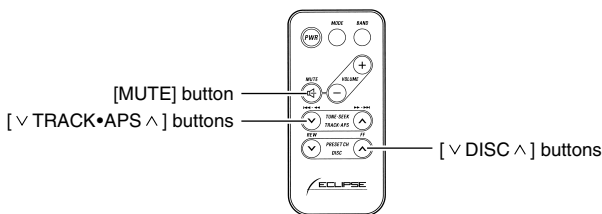

Advancing to the next track or returning to the beginning of the track being played

1 Press the [∨ TRACK•APS ∧] button.

[∧] button: Skips to the next track.

[∨] button: Returns to the beginning of the track being played. (Press repeatedly to move to previous tracks.)



Hold the [∧] button down to fast forward, or the [∨] button to rewind through the track being played.

Skipping to the next or previous disc

1 Press the [∨ DISC ∧] button.

[∧] button: Selects the next higher number disc.

[∨] button: Selects the next lower number disc.

Enabling the optional E-COM feature

Pressing the [MUTE] button for one second will switch the E-COM feature on or off.

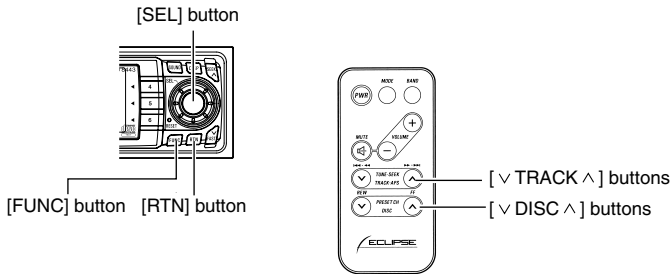

Switching the remote control settings

Remote control functions can be switched to the three patterns.

- 1** Press the [FUNC] button of the main unit.
- 2** Turn the [SEL] button to select Remote Func.
The selected item will be highlighted.
- 3** Press the [SEL] button.
The remote control function switching mode is activated.
- 4** Turn the [SEL] button to select a pattern.

The pattern is switched in the order of A, B, and C so that the E-com function can be supported. The selected item will be highlighted.

PATTERN A: Conventional functions

PATTERN B: [DISC ^] button.....Repeat
[DISC v] button.....Answer
[TRACK ^] button.....Next
[TRACK v] button.....Previous

Other functions than the above are conventional functions.

PATTERN C: [DISC ^] buttonOption4
[DISC v] buttonOption3
[TRACK ^] buttonOption2
[TRACK v] buttonOption1

Other functions than the above are conventional functions.

- 5** Press the [RTN] button.

At this time, other adjustments can also be made in Function Mode.

- 6** Press the [FUNC] button to exit Function Mode.

Replacing the battery



To prevent accidents, store batteries out of the reach of children. If a child has swallowed one, consult a doctor immediately.

Use one CR2025 battery.

- 1** On the back of the remote control, while pressing the locking knob on the battery slot cover toward your right, pull out the battery carrier with your fingernail.

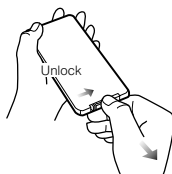

- 2** Remove the old battery, then place the new one in the carrier with the (+) mark facing up.

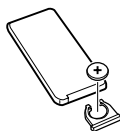

- 3** Push in the carrier until it snaps into place.

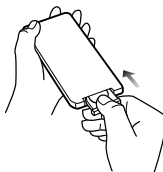

Be extremely careful not to swallow the battery.

How to use an optional NOB remote control

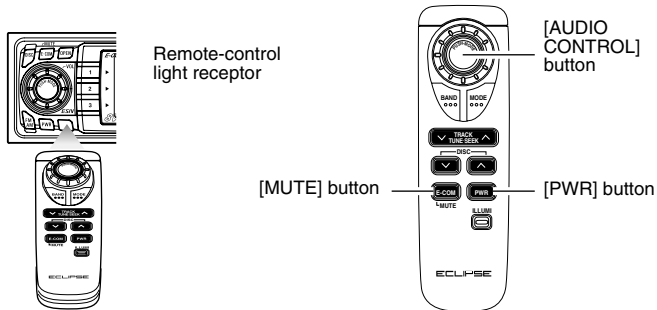

Turning the power on/off

When the power is turned on, the state used when the power was turned off such as CD and tuner playing is restored.

- 1 Press the [PWR] button.

The power turns on or off each time the button is pressed.



When the main unit is shut down, the remote control will not work.

Adjusting the audio volume

- 1 Press the [AUDIO CONTROL] button, and turn it to the left or right.

Each press of the button will switch the audio control modes.

Turn to the right: Increases the volume.

Turn to the left: Decreases the volume.

Cutting the volume instantly (muting)

Press the [MUTE] button for more than one second to cut the volume or restore it instantly.



Press the [MUTE] button for more than one second if E-COM is connected and less than one second if E-COM is not connected to cut the volume or restore it instantly.

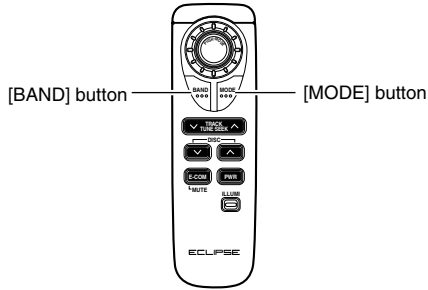

Switching playback modes

- 1 Press the [MODE] button.

Press the button to switch modes in the following sequence:



How to play the tuner

Select the tuner mode first.

Selecting the FM/AM band

- 1 Press the [BAND] button.

Each press will switch tuner modes from FM1 FM2
FM3 AM.

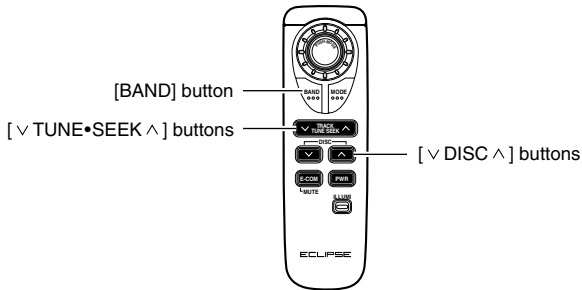

Selecting a station (manually or automatically)

A short press of the button will allow manual station tuning. Pressing for more than one second will start automatic tuning.

1 Press the [∨ TUNE•SEEK ∧] button.

[∧] button: Tunes to higher frequency stations.

[∨] button: Tunes to lower frequency stations.

Selecting preset stations

A total of six stations may be selected (preset tuning) out of those already set in memory through the main unit. (Refer to "Manually setting stations into memory," page 58.)

1 Press the [∨ DISC ∧] button.

[∧] button: Selects the next higher number preset button.

[∨] button: Selects the next lower number preset button.

How to play CDs

Select the disc mode first.

Switching disc modes

1 Press the [BAND] button.

When one or two CD changers are connected, press the [BAND] button to change modes from CD player → CD changer 1 → CD changer 2.

The indicator will skip a changer or player that has no discs loaded.

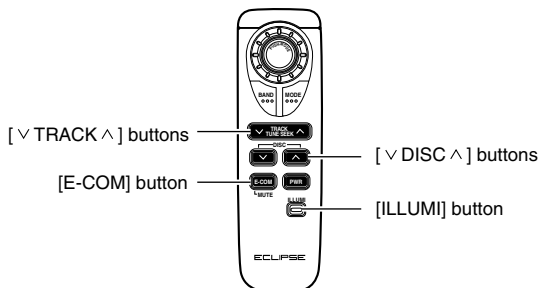

Advancing to the next track or returning to the beginning of the track being played

1 Press the [√ TRACK ^] button.

[^] button: Skips to the next track.

[√] button: Returns to the beginning of the track being played. (Press repeatedly to move to previous tracks.)



Hold the [^] button down to fast forward, or the [√] button to rewind through the track being played.

Skipping to the next or previous disc

1 Press the [√ DISC ^] button.

[^] button: Selects the next higher number disc.

[√] button: Selects the next lower number disc.

Illuminating the NOB remote control

The buttons of the NOB remote control will be illuminated by pressing the [ILLUMI] button.

Enabling the optional E-COM feature

Pressing the [E-COM] button for one second will switch the E-COM feature on or off.

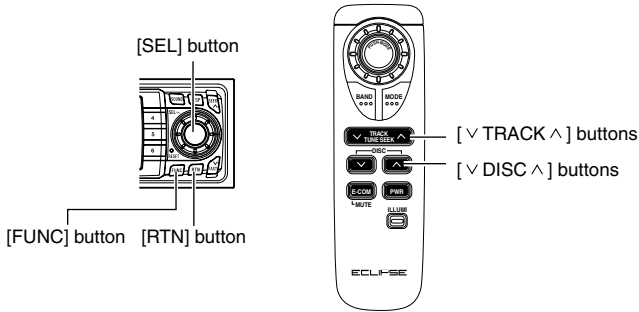

Switching the remote control settings

Remote control functions can be switched to the three patterns.

- 1** Press the [FUNC] button of the main unit.
- 2** Turn the [SEL] button to select Remote Func.
The selected item will be highlighted.
- 3** Press the [SEL] button.
The remote control function switching mode is activated.
- 4** Turn the [SEL] button to select a pattern.

The pattern is switched in the order of A, B, and C so that the E-com function can be supported. The selected item will be highlighted.

PATTERN A: Conventional functions

PATTERN B: [DISC ^] buttonRepeat
 [DISC v] buttonAnswer
 [TRACK ^] buttonNext
 [TRACK v] buttonPrevious

Other functions than the above are conventional functions.

PATTERN C: [DISC ^] buttonOption4
 [DISC v] buttonOption3
 [TRACK ^] buttonOption2
 [TRACK v] buttonOption1

Other functions than the above are conventional functions.

- 5** Press the [RTN] button.
At this time, other adjustments can also be made in Function Mode.
- 6** Press the [FUNC] button to exit Function Mode.

Replacing the battery



To prevent accidents, store batteries out of the reach of children. If a child has swallowed one, consult a doctor immediately.

Use two AA-size batteries.

- 1** Remove the back cover of the remote control unit by gently pressing and sliding it in the direction indicated by the arrow.

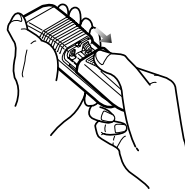

- 2** Install the two batteries provided into the compartment as illustrated inside the compartment.

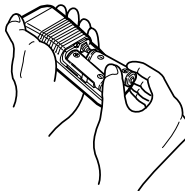

- 3** Return the back cover into place by sliding it in the direction indicated by the arrow.

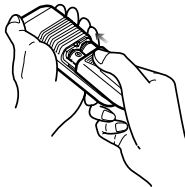



- Be extremely careful not to swallow the battery.
- The battery life is approximately one year. If the remote control unit does not operate correctly or if the button lamp gets dim, replace the batteries.
- Be sure to orient the batteries correctly so that the positive and negative poles match the diagram.
- Do not use one new battery and one old one; use two new batteries.
- Use only two of the same kind of battery.
- If any liquid is seen leaking from the batteries, remove both batteries and dispose of them properly. Thoroughly clean the battery compartment with a dry cloth. Then install new batteries.

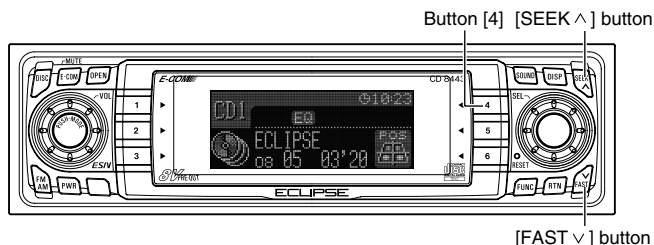

Fast Forward/Rewind

Fast forward or rewind the song currently being played.

- 1 Press and hold the [SEEK ^] or [FAST v] button.

[SEEK ^] button: Fast forward.

[FAST v] button: Rewind.

Playing the beginning of tracks (SCAN)

- 1 Press button [4].

Pressing the button causes the changer to move up to the next track and play it for 10 seconds, then move up to the next track and play it for 10 seconds, and so on, on one CD, until the button is pressed again.

Hold the button until the [ALL SCAN] display appears to play the first 10 seconds of the first track of every CD loaded.



- To continue playing a desired track, press the button again to stop scanning.
- After the entire disc is scanned once, ordinary playback starts from the point where scanning started.

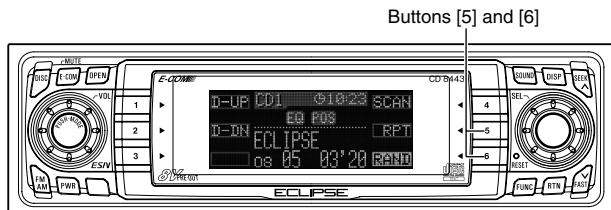

Repeating the same track (REPEAT)

- 1 Press button [5].

Pressing on the button causes the changer to repeat the track currently being played, until the button is pressed again. Hold the button until the [ALL REPEAT] display appears to repeat all tracks on the CD being played.

Playing tracks in random order (RANDOM)

- 1 Press button [6].

Pressing on the button causes the changer to play the tracks on the currently playing CD in random order. Hold the button until the [ALL RANDOM] display appears to play tracks from all of CDs loaded in the currently selected changer, in random order.



- Doing random playback, press button [5] to repeat the track being played. To cancel repeat play (go back to random play), press button [5] again.
During playback a particular track: The track being played is played repeatedly.
During searching: The following track is played repeatedly.
- Occasionally the same track happens to be played (selected) two or more times in a row, but it is no sign of a problem.
- When any of the functions - “Playing the beginning of tracks,” “Repeating the same track” and “Playing tracks in random order” - is selected, a message such as [SCAN], [ALL SCAN], [REPEAT], [ALL RPT], [RANDOM] or [ALL RAND] appears on the display to verify the current function.

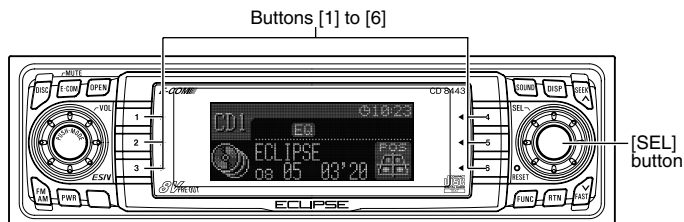

Skipping to the next or previous CD

- 1 Press button [1] or [2].

Button [1]: Selects the next higher number disc.

Button [2]: Selects the next lower number disc.

Specifying a CD to play

A CD of your choice is directly selectable out of the loaded discs.

- 1 Press the [SEL] button for less than one second.
- 2 Press a button from [1] to [6].

Buttons	1	2	3	4	5	6
CD	1	2	3	4	5	6
	7	8	9	10	11	12

To select a CD from nos. 7 to 12, press the desired button considerably longer.

Others

[DISC] button



Connecting Portable Audio Players to the AUX Jack

Use a commonly available accessory cord with stereo mini-plug to connect the audio output jack (LINE) or headphone jack of a portable audio player to the AUX (auxiliary) jack of this system.

- 1** Turn on the portable audio player and start its play function.
- 2** Switch to AUX mode by pressing the [DISC] button for more than one second.

Activation of the AUX mode will light the "AUX" indicator and channel audio player output to the system speakers.



ATTENTION

- While the AUX mode is activated, actions such as turning off the audio player or pulling out the connection cord may cause noise spikes that can damage the system speakers. Be sure to avoid this possibility by turning off system power or switching from AUX mode to another mode before shutting off or disconnecting the portable audio player.
- Audio output levels will differ for the various devices that can be connected by this method. Carefully adjust volume until the output level of the connected player is known.
- Before using a portable audio player in a vehicle, read the player's operation manual carefully and confirm problem-free operation in the vehicle before proceeding.

If you have a question:

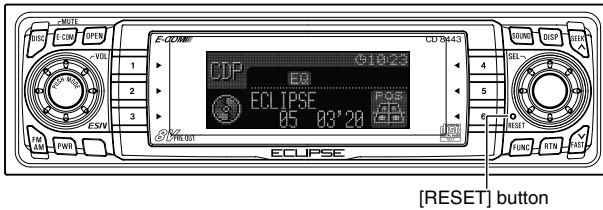



First check the items mentioned below before attempting to troubleshoot problems.



If a problem occurs, for instance when the unit does not respond to any button presses, or the display doesn't work correctly, press the [RESET] button using a sharp tool. Pressing the [RESET] button will delete all the entries from memory. The settings will return to those made at the factory prior to shipment.

Displayed information (for troubleshooting)

The information listed in the chart below is displayed to show the status of the CD player and CD changer. Refer to the chart for the appropriate action.

Information Code Table	When "INFO  flashes on the indicator ↑ Nos.2~7 are displayed.
 Information Contents	Explanation and remedial action to take
2 NO DISC LOADED IN THE MAGAZINE	There is no disc in the magazine or player. Load a disc in the magazine. (Load a music disc.)
3 DISCS ARE DIRTY OR DAMAGED	The loaded disc is dirty or upside down. Check it for proper orientation and verify it is clean.
5 CD PLAYER AND CD CHANGER FAILS MECHANICALLY	<ul style="list-style-type: none"> •The CD player and CD changer is inoperative for some reason. Go through the magazine removal procedure. •If a magazine fails to eject, have your dealer fix the problem.
6 WHEN THE CD CHANGER INTERNAL TEMPERATURE IS HIGH (TO PROTECT PICKUP UNIT)	<ul style="list-style-type: none"> •The temperature in the CD changer is too high for operation. Wait till it cools down. •Resume playing after the "High temperature sensed and CD stopped" display disappears. If the CD still cannot play, have your dealer repair it.
7 AN INTERNAL POWER SUPPLY FAILURE IS OCCURRING WITH THE AUTO CHANGER	<ul style="list-style-type: none"> •Turn the ACC off once before turning it on once again to resume the operation. •If the function still cannot be restricted, contact your dealer.
Information Contents	Explanation and remedial action to take
LOAD	CD changer is in the process of verifying the presence of CDs after a magazine has been inserted into the CD changer.

Mode	Problem	Causes	Remedial action to take	Refer to page
Common to all	Dead or weak sound	Is the volume control up sufficiently?	Turn up the volume control.	23
		Is the muting function in effect (MUTE)?	Cancel the muting (MUTE) function.	23
		Is the fader or balance control set far to one side?	Readjust the fader and balance controls to more normal positions.	24
		Other probable causes include broken audio-signal wiring or a faulty speaker.	Have your dealer check the problem.	—
	Power does not turn on.	Are too many electrical items installed, causing a lack of power?	Have your dealer check the problem.	—
		Other probable causes include a run-down car battery, broken power or interconnection wiring.	Have your dealer check the problem.	—
	Frequencies or titles set in memory are deleted.	Has the car battery been disconnected for repair or checked out?	Reenter them into memory.	57, 58
		Are too many electrical items installed and causing lack of available power?	Have your dealer check the problem.	—
		Other probable causes include run-down car battery, broken power or interconnection wiring.	Have your dealer check the problem.	—
	No guide tone sounds.	Is the guide tone disabled?	Enable the guide tone.	31
	The remote control does not work.	Is the battery low?	Replace battery.	104, 110
		Is the battery installed in reverse polarity?	Reinstall the battery in the correct polarity.	104, 110
		Is direct sunlight hitting the remote control light receptor?	Use the remote control close to the receptor.	—
		Other probable causes include a malfunctioning remote control.	Have your dealer check the problem.	—

Mode	Problem	Causes	Remedial action to take	Refer to page
CD	The disc cannot be inserted. The disc is ejected as soon as it is inserted. Or, the disc cannot be ejected. The disc cannot be changed.	Is an extra label or seal applied to the disc?	Do not apply labels or seals to the disc.	11
		Are there rough edges, deformations or damaged areas on the disc?	Try inserting another disc. Removed any burrs. Do not use a deformed or damaged disc.	12
	Sound skips around. Sound is intermittent. Sound is bad in quality.	Is the disc damaged? (scratched, warped, etc.)	Try another disc. Do not play a damaged disc.	11
		Is the disc clean?	Clean the disc.	13
		Is the player mounted at a proper angle? Is the player mounted loosely?	Have your dealer check it out.	—
		Are you driving over a rough surface?	Avoid playback while driving over rough surfaces.	10
	The disc cannot be ejected.	If unknown	Press the [DISC] button a bit longer and then press the [OPEN] button (forced Eject).	—

Mode	Problem	Causes	Remedial action to take	Refer to page
Tuner	Receives no stations, or receives static noise.	Is the antenna retracted?	Extend the antenna.	—
		Is the tuner correctly tuned to a station?	Tune to a station.	56
		Are you driving outside the service area of your preset stations?	Tune to a local station. (Please note, there may be no local stations servicing the area where you are currently driving.)	56
		Are you operating other equipment with a computer, or a mobile phone, in your vehicle at the same time as your receiver?	Avoid operating such equipment while using the receiver.	—
		Other problems may include a loose or disconnected antenna cable, a bad antenna cable or a bad	Have your authorized Eclipse retailer check the problem.	—

Specifications

<GENERAL>

Power Supply	14.4V DC (11-16V)
Current Drain	2A MAX
Dimensions (W x H x D)	
In-Dash Unit	7" x 2" x 6-1/8" (178 x 50 x 155mm)
Mass (weight)	Approx. 1.7kg

<FM TUNER>

Frequency Range	87.75~107.9MHz (200kHz step)
Usable Sensitivity	13dBf
Frequency Response	30~15,000Hz, ± 3 dB
Stereo Separation	38dB

<AM TUNER>

Frequency Range	530~1,710kHz (10kHz step)
Usable Sensitivity	20 μ V

<CD SECTION>

Frequency Response	20~20,000Hz, ± 3 dB
Wow & Flutter	Below measurable limits
Stereo Separation	85dB
S/N Ratio (A-weighted)	100dB
Dynamic Range	98dB
Total Harmonic Distortion	0.02%

<AUDIO AMPLIFIER>

Power Output	13W x 4 (20~20,000Hz, 0.8% THD, 4 Ω) Max. 50W x 4
Output Level/Impedance	Unbalanced output: 8V (0dB CD) 55 Ω line-out impedance
Loudness	+10dB at 100Hz/+6dB at 10kHz

Before installation

● Note ●

Be sure to disconnect the battery's negative terminal before installing the receiver.

Components

No.	Item	Q'ty
1	Main unit	1
2	Mounting sleeve	1
3	Side bracket	2
4	Rear bracket	1
5	Bezel	1
6	Bushing	1
7	Self-tapping screw (6 x 16 mm)	2
8	Stud bolt	1
9	Phillips type screw (5 x 8 mm)	4
10	Hex-head bolt (5 x 20 mm)	2
11	Hex nut (5 mm)	2
12	Interconnecting cable	1
13	Remote control	1

Setting the system-selector switch

When this receiver is used in combination with an external amplifier, etc., the selector switch on the left side of the main unit may have to be switched.

Set the switch according to the table below:

External amplifier	EQ/XOVER	Switch
None	None	OFF*
None	Connected	ON
Connected	Connected	OFF*
Connected	None	OFF*

* : Pattern of selector switch at shipping

MAIN UNIT LEFT SIDE VIEW

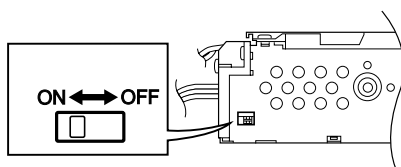

Installation angle

To maintain proper function, the unit must be mounted less than 30 degrees. If the angle is in excess of 30 degrees, CD skipping and improper CD ejection may occur.

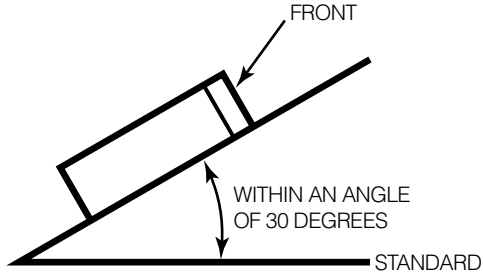

Mounting instruction

● Note ●

Be sure to install the back strap to support the main unit. Failure to install the back strap correctly may cause CD skipping.

Mounting the main unit

- 1** Insert the mounting sleeve into the opening in the vehicle console.
- 2** Use a screwdriver or a similar tool to bend the tabs in the mounting sleeve to secure the mounting sleeve.

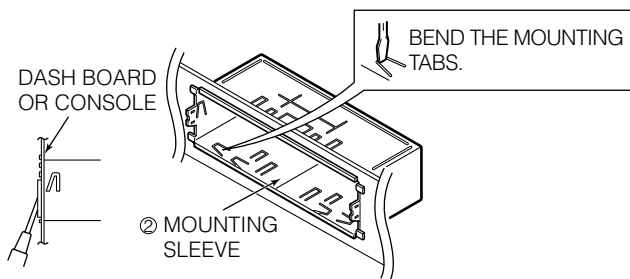

- 3** Attach the side brackets to the main unit using phillips type screws.

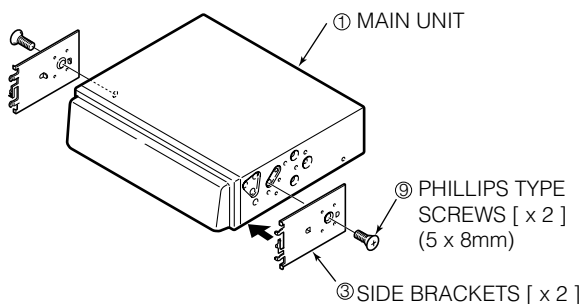

- 4** Mount the stud bolt to the main unit.
- 5** Insert the main unit into the mounting sleeve until it locks in place.
- 6** Fasten the rear of the main unit using either method [A] or [B].

Select method [A] or [B] to suit the interior configuration of the vehicle.

- 7** Install the bezel on the main unit.

Some automobiles may be equipped to secure the back of the main unit using the stud bolt and supplied rubber support.

[A]

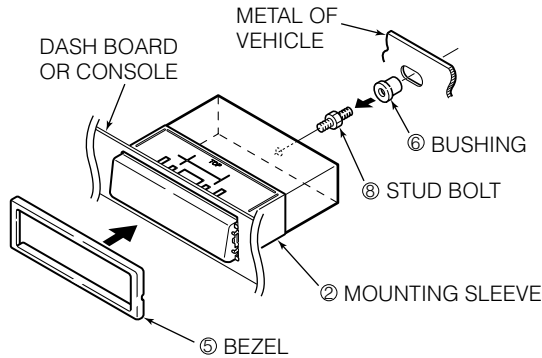

[B]

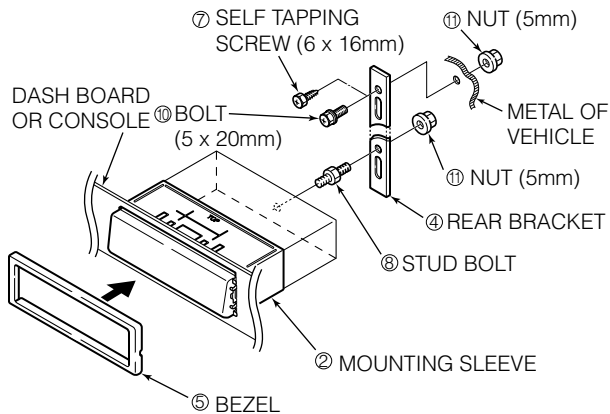

● Note ●

To prevent unconnected leads from shorting out, insulate them by wrapping their tips with electrical tape. Similarly, insulate the ends of connected leads.

If an external amplifier is to be connected to the receiver, be sure to ground its outside housing to the vehicle body (a metal part).

Names of lead wires and destinations (refer to Page 128)

No.	Name	Wire color	Destination
1	ACC	Red	Connect where the power comes on when the ignition is in the ACC position.
2	B+	Yellow	Connect where the power is constantly available, regardless of the ignition switch's position.
3	Ground	Black	Connect where good body grounding is available.
4	Antenna power supply	Blue	Connect to the automatic-antenna control terminal of the vehicle.
5	Illumination power supply	Orange/White	Connect to where power comes on when the headlights are turned on.
6	Control power supply	Blue/White	Connect to the control terminal for the external amplifier, etc.
7	E-LAN terminal		Connect to the E-LAN terminal of the CD changer, etc.
8	Line-in/out terminals (Front/Hi)		Connect to the RCA input connectors of an external amplifier, or to the RCA output connectors of a EQ.
9	Line-in/out terminals (Rear/Mid)		
10	Line-out terminals (Nonfader/Low)		Connect to the RCA input connectors of a EQ, or the RCA input connectors of a woofer amplifier.
11	Speaker terminals		Connect them to their respective speakers.
12	Cellular phone mute	Pink	Connect to the ground output terminal on a mobile phone.
13	Digital out terminal		Connect to digital input terminal of the Eclipse Commander module.
14	Eclipse Commander terminal		Connect to the Eclipse Commander module.
15	Line in terminal		Connect to the mini plug (φ3.5) output connector of Portable unit (MP3 player, MD player, etc.).

For external equalizer hook-up using the radio's internal amplifier. See Page 122 for details. *Move the selector Switch from Off-On.* Use (10) Non-Fader pre-amp output, as the input to the equalizer. Use (8) Front pre-amp Output/Input, as the radios Front pre-amp input: Connect to the equalizers Front-output. Use (9) Rear pre-amp Output/Input, as the radios Rear pre-amp input: Connect to the equalizers Rear-output.

System

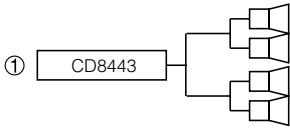

Note:
Adjust the external amplifier's input level.

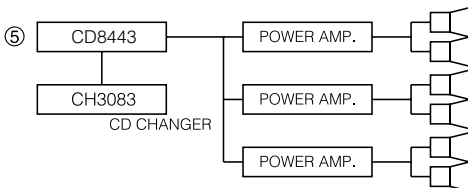
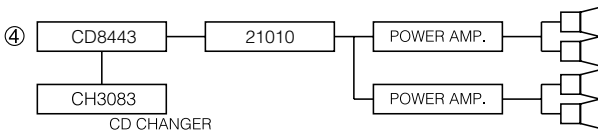
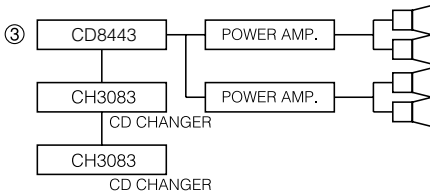
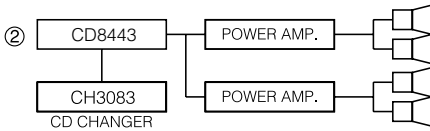

1) CD8443 Receiver, used alone

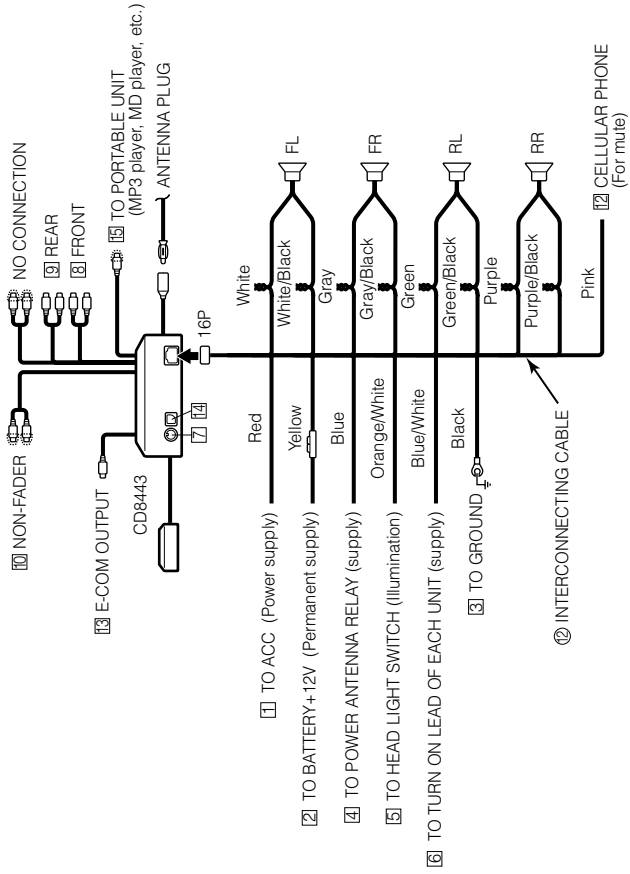

2) CD8443+ CH3083 + Power Amplifier

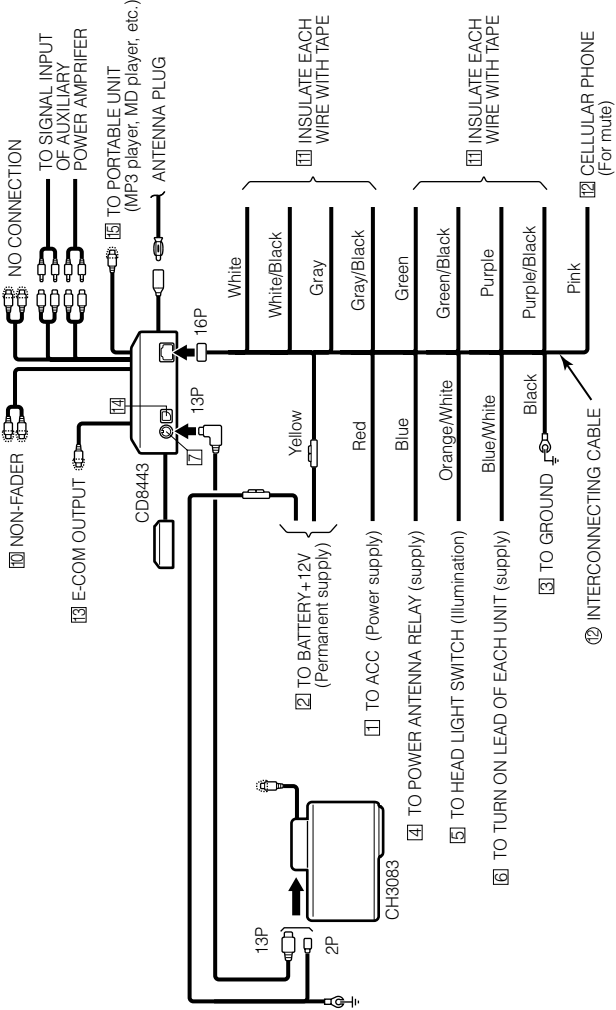

3) CD8443+ CH3083 + Power Amplifier

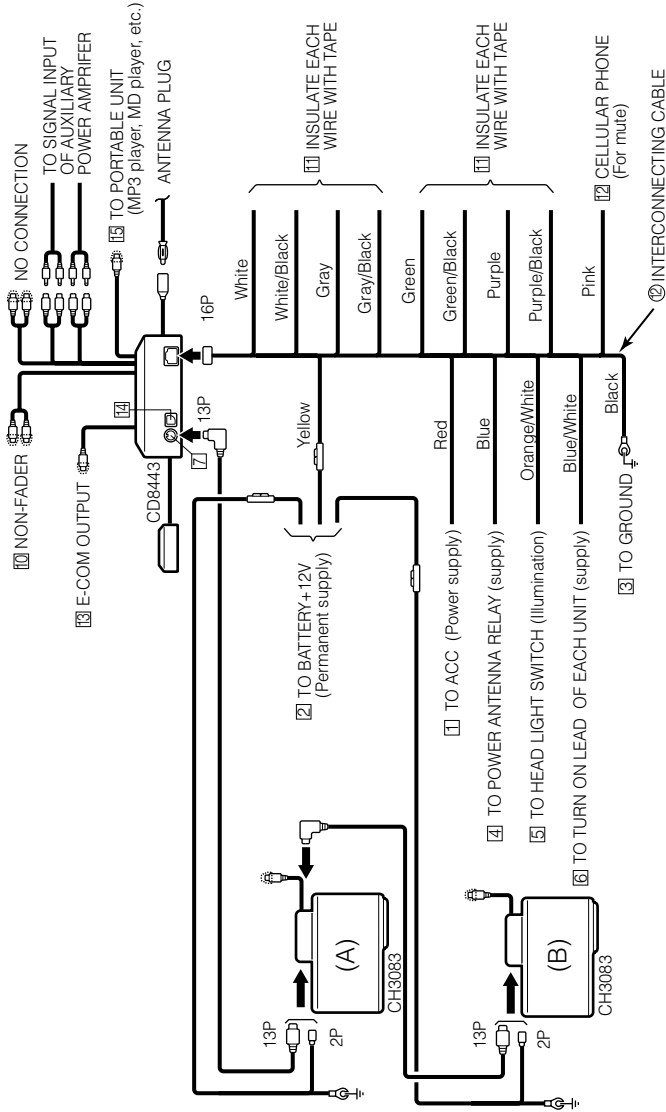

Note : 1. The switch on the back side of CD changer (A) must be set to the 'L' position.
 2. The switch on the back side of CD changer (B) must be set to the 'H' position.

4) CD8443+ CH3083 + 21010 + Power Amplifier

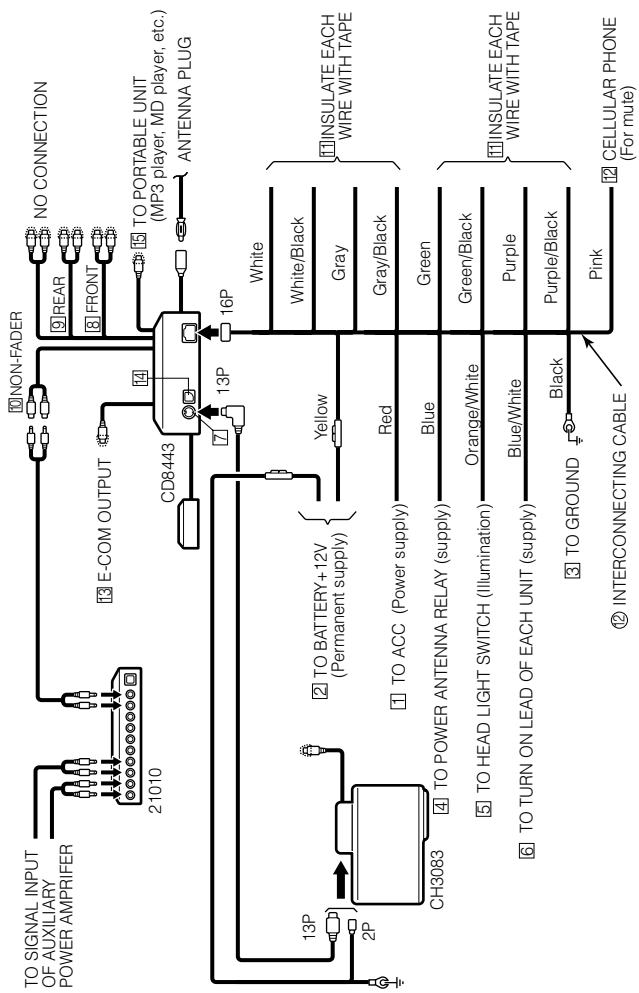

5) CD8443+ CH3083 + Power Amplifier (for Pro-Mode)

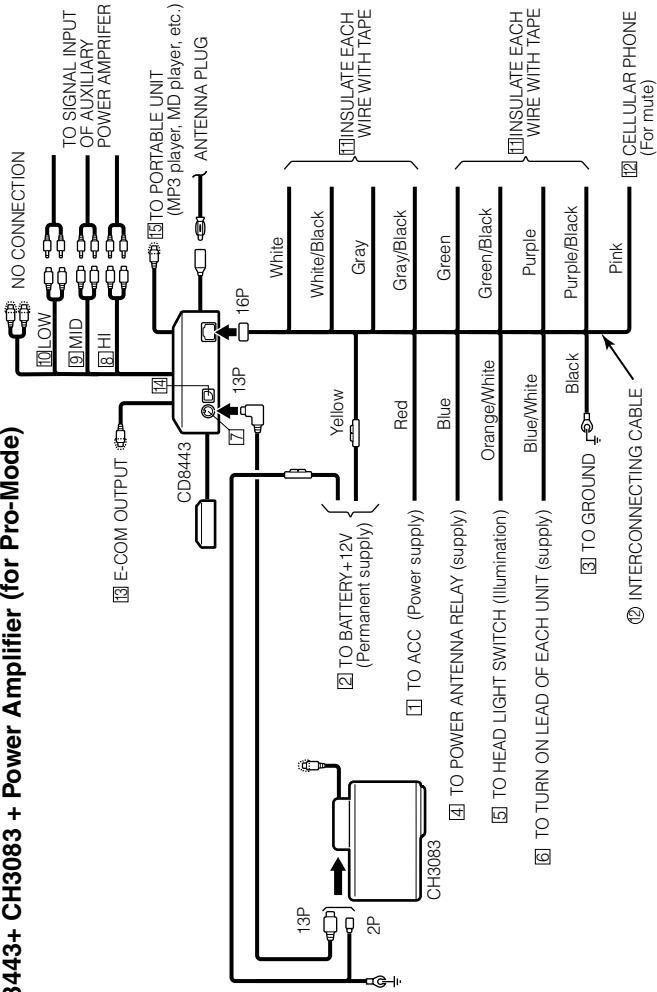

IMPORTANT

**RECORD YOUR “KEY CD”
HERE...**

**STORE YOUR “KEY CD”
ALONG WITH YOUR
OWNER’S MANUAL IN
YOUR SOCK DRAWER.**



This device complies with part 15 of the FCC Rules. Operation is subject to the condition that this device does not cause harmful interference.

CUSTOMER NOTICE

Please retain this booklet and write in the serial number of your CD8443 for identification. The serial number is labeled or stamped on the chassis.

Serial No. _____



DIVISION OF FUJITSU TEN CORP. OF AMERICA
19600 SOUTH VERMONT AVENUE, TORRANCE, CA 90502
(310) 327-2151

090001-1442A700
0303 (Y.O)