



OWNER'S MANUAL



This device complies with part 15 of the FCC Rules. Operation is subject to the condition that this device does not cause harmful interference.

CUSTOMER NOTICE

Please retain this booklet and write in the serial number of your CD5415 for identification. The serial number is labeled or stamped on the chassis.

Serial No.

CD5415 ESN E5 High-Power CD Receiver with MP3 Decoder

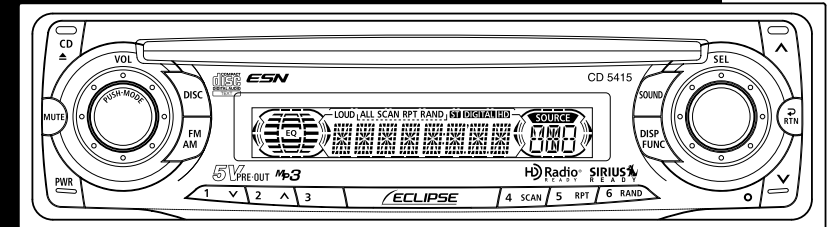

CD5415

ESN E5 High-Power CD Receiver with MP3 Decoder

OWNER'S MANUAL

We appreciate your purchase of this receiver. Please read through this manual for correct operation. We suggest that after reading it you keep this manual in a safe place for future reference.

FUJITSU TEN LIMITED

Contact: FUJITSU TEN CORP. OF AMERICA
19600 So. Vermont Avenue, Torrance, CA 90502
Call: 800-233-ECLIPSE

www.eclipse-web.com

"ECLIPSE" is a registered trademark of FUJITSU TEN LIMITED in 48 countries including the U.S. and Japan.

090001-1465A700 0501MT (F.O)



For your safety in using the CD5415

Warnings and caution signs, illustrated below, are posted throughout this manual as well as on the CD5415. They show safe and correct ways to handle the product so as to prevent personal injury to you, others and to avoid property damage.

Before reading through the manual, take time to read through and learn the important information listed in this section.



Warning

This sign indicates a situation in which incorrect handling or disregard of this sign might result in death or serious personal injury.



Caution

This sign indicates a situation in which incorrect handling or disregard of this sign might result in personal injury or may result solely in damage to property.



Warning

- Do not modify this system for use other than that specified herein. Also, do not deviate from the installation procedures described herein; Eclipse will not be held liable for damages including, but not limited to serious injury, death or property damage resulting from installations that enable unintended operation.
- This equipment requires 12V DC and should only be installed in a vehicle with a 12V negative ground electrical system. Any other installation may cause a fire or other severe damage to the equipment and the vehicle.
- Never install this equipment where it will interfere with safe operation of the vehicle. Never block the driver's view. Do not install equipment where it may interfere with operation of the brakes, the steering or any safety equipment, including seat belts and air bags.
- Before drilling holes in a vehicle for installation, you must confirm the locations of pipes, tanks, electrical wiring, and other vehicle systems and components to ensure that there will be no interference or contact. In addition, you must also apply rust prevention and leak prevention measures at the drilling area. Otherwise, fire or electric shock could occur.



Warning

- When installing equipment do not remove or alter existing vehicle fasteners, including nuts, bolts, screws, clips, and fittings. Never detach, move or alter existing vehicle wiring, including electrical grounds and straps. Alteration of existing vehicle components may make vehicle unsafe to operate.
- Before installation, remove the negative (-) battery terminal to prevent shocks, electrical arcing, fires, and damage to vehicle wiring and the equipment you are installing.
- Secure wiring with tape or plastic ties so that wires do not interfere with vehicle operation, including brake pedal, gear shifter and steering. Position wires so that they will not be rubbed, abraded, or damaged by moving vehicle components, including power seats.
- To avoid equipment and vehicle damage, including fire, never supply power to installed equipment in a way which will overload the capacity of an existing vehicle circuit. Never leave a power supply wire or connection uninsulated. Always install supplied fuses, circuit breakers, and relays.
- Air bags are vital safety equipment. Never install equipment in a way which will alter air bag wiring or interfere with air bag deployment. Air bags must function properly in the event of an accident.
- When installation is complete, test all vehicle electrical systems for proper operation, including lights, horn, brake lights, and emergency flashers.
- For your protection, never use a power drill without safety glasses or goggles. Debris or broken drill bits may cause severe eye injuries, including blindness.
- Use electrical tape to insulate the ends of all wires, even if not used. Proper insulation prevents arcs, shocks and fires.
- Some equipment uses batteries. Never install equipment where young children can get access to batteries. If a battery is swallowed, seek medical attention immediately.
- When vehicle is moving, never take your eyes off the road to make adjustments to the equipment. You must pay attention to the road to avoid accidents, do not let the operation or adjustment of the equipment distract you from proper vehicle operation.
- The driver should not look at the screen while driving. Accidents may result if you are not paying attention to the forward direction.
- Do not put foreign objects in the loading slot of disc. Fires or shocks may result.

 **Warning**

- Do not disassemble or alter this equipment. Accidents, fires or shocks may result.
- Do not let water or foreign objects enter the internal parts of this equipment. Smoke, fires or shocks may result.
- Pay attention to where the remote control is left. Traffic accidents or problems with driving may result if the remote control makes its way under the brake pedal etc. when the vehicle is stopped or when it goes around a corner.
- Do not use when it is broken (the screen is not lit or no sound comes out). Accidents, fires or shocks may result.
- Always replace fuses with fuses of identical capacity and characteristics. Never use a heavier fuse than the original. Using the wrong type of fuse may cause a fire or severe damage.
- If foreign objects or water enters the equipment, smoke comes out, or there is a strange odor, stop using it immediately, and contact your dealer. Accidents, fires, or shocks may result if you continue to use it in these conditions.
- The driver should not change the CD while driving. As accidents may result if you are not paying attention to the forward direction, first stop the car at a safe location and then proceed.
- Plastic bags and wrappings may cause suffocation and death. Keep away from babies and children. Never put bag over your head or mouth.

 **Caution**

- Wiring and installing this equipment requires expertise and experience. Professional installation is recommended. Consult with your dealer or a professional installer. Incorrect wiring may damage the equipment or interfere with safe vehicle operation.
- Use only the accessory parts as specified. Using other parts may cause damage to the equipment or cause parts to fall or fly off the equipment.
- Do not install the unit in places where it may get dew condensation on (around the air conditioning hose, etc.), come in contact with water, or in condition of high moisture, dust or oily smoke. If water, moisture, dust or oily smoke enters this unit, smoke, fires or malfunctions may result.



Caution

- Avoid installing in places where it cannot be fastened securely or where there are strong vibrations. Also, if you installed the unit with double-sided tape, first wipe away dirt and wax from the installation area. Otherwise, the unit may come loose due to vibration while driving, causing problems for driving and resulting in traffic accidents or injuries.
- Do not install in places with direct sunlight or where it will be hit directly by hot air from the heater. This may increase the temperature of the interior of this equipment, resulting in fires and malfunctions.
- Do not block the fan, heat sink or vents for this unit. When fan, heat sink or vent is blocked, the interior overheats, and fires may result.
- Connect as specified in the installation manual. If not connected normally, fires or accidents may result.
- When installing in vehicles equipped with air bags, check the manufacturer's cautions regarding operation before operating. Airbags may not operate properly.
- Carry out the wiring such that cords are not pinched by movable parts such as seat rails, and screw parts of the vehicle body. Accidents, fires and shocks may result from disconnection and electrical shorts.
- Carry out the wiring such that the cord does not make contact with metal parts. The cord is may be damaged by contact with metal parts, resulting in fire and shocks.
- Avoid hot surfaces when wiring equipment. High temperatures may damage wiring, causing shorts, arcing and fires.
- When changing the installation location for this equipment, please consult the dealer where you bought it for safety reasons. Expertise is necessary for removal and installation.
- Keep volume to a reasonable level so that you can hear sounds from outside the vehicle, including warning sounds, voices, and sirens. Failure to do so may cause an accident.
- Do not put your hands or fingers into the loading slot of disc. Injuries may result.
- Do not touch the heat dissipating part of the amp. Burns may result from the heat of this part.
- Do not recharge dry batteries. Dry batteries may rupture, resulting in injuries.

 **Caution**

- Do not use batteries other than those specified. Also, do not mix old and new batteries. Injuries or pollution to the surroundings may result from battery ruptures and leakage.
- When inserting batteries into the equipment, be careful of the polarity (positive/negative), and insert them as indicated. If the battery polarities are incorrect, injuries and pollution to the surroundings may result from battery ruptures and leakage.
- Replace used batteries as soon as possible; they may leak and damage equipment. Battery leakage can burn your skin or your eyes. Wash hands after handling.
- If alkaline solution from alkaline dry batteries makes contact with your skin or clothes, flush with clean water. If any of the solution gets in your eyes, also flush clean with water and then seek medical attention.
- When disposing of lithium dry batteries, affix insulating tape to the positive and negative terminals, and after they are insulated, dispose of them according to the "Local municipal directives". Shorts, fires and ruptures may result from disposal together with other electrically conductive objects such as metal parts, etc.
- Do not short, disassemble or heat the batteries, or place them in fire or water. Fire and injuries may result from battery rupture and leakage.
- Store the remote control in a place away from direct sunlight, high temperatures, and high moisture levels. The case may change shape, and the batteries may rupture and leak.
- Do not use this equipment except for in-vehicle use. Shocks or injuries may result.
- Be careful of the position of the volume when turning the power source ON. Hearing damage may result if very loud noise is emitted when the power is turned ON.
- Do not operate under abnormal conditions such as when the sound is broken or distorted. Fires may result.
- This equipment uses invisible laser light. Do not disassemble or alter this equipment. If trouble occurs, contact the dealer where you bought the equipment. Altering this equipment may cause exposure to laser emissions (worsening eyesight), or result in accidents, fires or shocks.
- If the equipment is dropped or the cabinet is broken, turn off the power to the main unit and contact your dealer. If used in this condition, fires or shocks may result.

Table of Contents

Operating precautions	11
Notes on operation	11
About compact discs	12
About cleaning a CD	14
Names of controls and parts	15
ESN security operating procedure	16
About ESN	16
How to operate the ESN (Key CD) security	17
How to program the Key CD	17
How to cancel the Key CD	18
How to change the Key CD	19
How to resume normal operation (ESN security lock out) ...	19
What happens if an incorrect CD is inserted?	20
How to turn the security indicator on/off	21
How to read the Electronic Serial Number	21
Basic operation	22
Turning the power on and off	22
Listening to a CD	23
Listening to the tuner	24
Adjusting audio volume	25
Switching audio control modes	26
VOL (VOLUME) Mode	26
BASS Mode	26
MID (MIDDLE) Mode	26
TREB (TREBLE) Mode	27
BAL (BALANCE) Mode	27
FAD (FADER) Mode	27
NON-F (NON-FADER) Mode	27
NF-P (NON-FADER PHASE) Mode	28
LOUD Mode	28
Storing user presets for the equalizer	29
Changing the equalizer mode	30
Making changes with Function Mode	31
Disabling the guide tone feature (for button operation)	31
Setting the time	32

How to operate the CD player 33

Listening to CDs 33
Advancing to the next track or returning to the beginning of the track being played 34
Fast Forward/Rewind 34
Playing the beginning of tracks (SCAN) 34
Repeating the same track (REPEAT) 35
Playing tracks in random order (RANDOM) 35
Ejecting the disc 36
Displaying CD TEXT 36

How to operate the MP3 player 37

About MP3 37
 What is MP3? 37
 Playable MP3 file standards 37
 ID3 tags 37
 Media 38
 Format of discs 38
 File names 39
 Multi-sessions 39
 Playing MP3 39
 MP3 playing time display 39
 Display order of MP3 file/folder names 39
Listening to MP3 file 40
Advancing to the next track (file) or returning to the beginning of the track (file) being played 41
Fast Forward/Rewind 41
Skipping to the next or previous folder 41
Return to the root directory of the CD 42
Playing the beginning of files (SCAN) 43
Repeating the same file (REPEAT) 43
Playing files in random order (RANDOM) 44
Displaying title 45

How to operate the tuner 46

Tuning to a station 46
Entering stations into memory automatically
 (The automatic preset mode: ASM) 47
Manually setting stations into memory 48
Preset station scan 49
Switching the display 49
Changing the reception sensitivity for automatic scanning 50

Changing the radio band location	51
FM reception characteristics	52
FM reception differs from AM	52
Fading out	52
Reception area of FM broadcasts	53
Multipath	53

How to use an optional remote control 54

Precautions in use of the remote control	54
Cleaning the remote control	54
Turning the power on/off	55
Adjusting the audio volume	55
Muting the volume	55
Switching playback modes	56
How to play the tuner	56
Selecting the FM/AM band	56
Selecting a station (manually or automatically)	57
Selecting preset stations	57
How to play CDs	57
Switching disc mode	57
Advancing to the next track or returning to the beginning of the track being played	58
Skipping to the next or previous disc	58
Listening to MP3 file.....	59
Switching the disc mode	59
Advancing to the next file or returning to the beginning of the file being played.....	60
Skipping to the next or previous folder	60
Fast Forward/Rewind	60
Replacing the battery	61

***How to operate the receiver with an optional
CD changer connected..... 62***

Listening to a CD.....	62
Advancing to the next track or returning to the beginning of the track being played.....	62
Fast Forward/Rewind	62
Playing the beginning of tracks (SCAN).....	63
Repeating the same track (REPEAT).....	63
Playing tracks in random order (RANDOM)	64
Skipping to the next or previous CD.....	64
Specifying a CD to play.....	65

Switching the display 65

**How to operate the tuner with an optional
HD RADIO tuner connected (U.S.A. only) 66**

About HD Radio 66
Tuning to a station 67
Entering stations into memory automatically
(The automatic preset mode: ASM) 68
Manually setting stations into memory 69
Preset station scan 70
Switching between displays when receiving HD Radio 71
HD Radio reception settings 72

**How to operate the tuner with an optional SIRIUS
satellite radio tuner connected (U.S.A. only) 73**

About SIRIUS satellite radio 73
Selecting the radio mode 74
Tuning to a channel 74
Category selection 75
Direct channel selection 75
Manually setting channels into memory 76
Preset channel scan 77
Switching displays when using the SIRIUS satellite radio 77

If you have a question: 78

Displayed information (for troubleshooting) 79

Specifications 82

Before installation 83

Components 83
Installation angle 83

Mounting instruction 84

Mounting the main unit 84
Names of lead wires and destinations 87
System 88

How to contact customer service 93

Operating precautions

<Your CD5415 will perform well over a long period of time through correct handling and care.>

Notes on operation

- For your safety, play only at volume levels that allow outside sounds to be heard.



- We recommend using with this player a disc with the logo shown to the left.
- You can play music CDs (CD-R/CD-RW) on this player. Be sure to use discs that have been properly processed.

Depending on the editing equipment used, some discs may not play properly.

- Do not insert anything other than a CD into the disc slot.

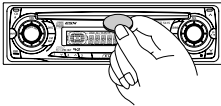

Do not insert any foreign objects, such as coins or credit cards, into the disc slot. Be especially watchful of children's mischief in this regard.



- Avoid severe mechanical shock.

When the player is subjected to severe vibration while traveling over a rough surface, playback may be intermittent. When a situation like this occurs, resume playback after returning to a smoother road.



- About dew condensation.

In cold or rainy weather, just as the interior glass surface gets fogged, dew (water condensation) may also settle on the deck. When this occurs, disc playback may become intermittent or impossible. Dehumidify the air in the vehicle for a while before resuming playback.

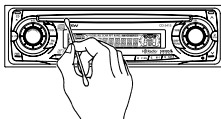

- Cleaning the disc slot.

The disc slot tends to get dusty. Clean it occasionally to prevent accumulated dust from scratching the discs.

About compact discs

- The signal recorded on a compact disc is read by a laser beam, so nothing touches the disc surface. A scratch on the recorded surface or a badly warped disc may cause deteriorated sound quality or intermittent playback. Observe the following precautions to ensure high quality sound performance:

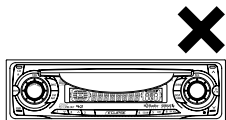

- Do not leave an ejected disc in the disc slot for very long; the disc may warp. Discs should be stored in their cases and kept away from high temperature and humidity.

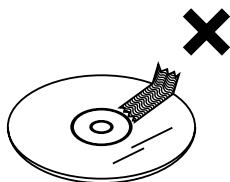

- Do not stick a piece of paper or tape on, nor write on or scratch either side of a disc.

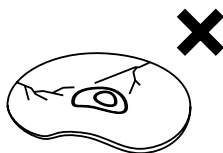

- Discs spin at a high speed inside the deck. Keep cracked or warped discs out of the player to avoid damaging it.

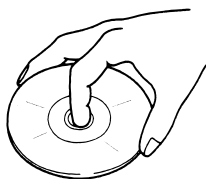

- Avoid touching the recorded surface when handling a disc; handle discs by their edges.

About brand new CDs

- You may notice that some brand new discs are rough around the center hole or outside edge. Remove the rough edges with the side of a ballpoint pen, etc. Rough edges may prevent proper loading in the deck. Flakes from the rough edges may also stick to the recorded surface and interfere with playback.

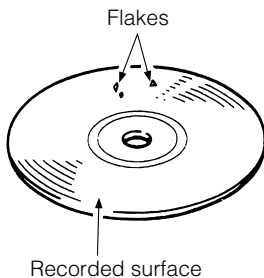
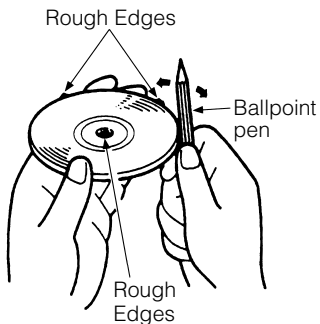

About CD accessories

- Do not use accessories (stabilizers, protective seals, laser lens cleaners, etc.) sold for "improving sound performance" or "protecting CDs." The changes in CD thickness or outside dimensions made by these accessories may cause problems in the player.

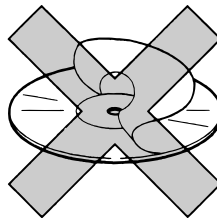

- Please be sure NOT to attach any ring-shape protector (or other accessory) to your discs. Those protectors are commercially available and said to protect disc and to improve sound quality (and antivibration effect), but they can do more harm than good in regular uses. The most common problems are disc insertion, disc ejections, and won't play problems due to the protector ring that came off in the disc mechanism.

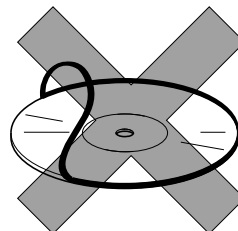

About borrowed CDs

- Do not use a CD with glue or remnants of adhesive tape or labels. They may cause the CD to get stuck inside or damage the deck.

How to remove CDs

- When removing the ejected disc, pull it straight out along the slot. Pressing downward in the process may scratch the recorded surface of the disc.

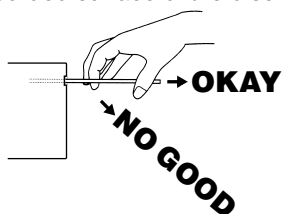

About irregularly-shaped CDs

- Specially-shaped CDs, like heart-shaped or octagonal CDs, cannot be played. Do not attempt to play them, even with an adapter, since they may damage the player.

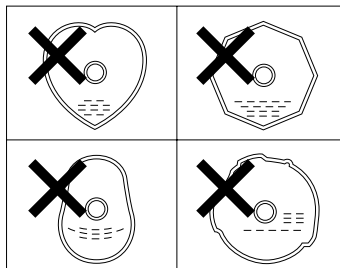

About cleaning a CD



- Use a commercially available compact disc cleaner to clean a CD, wiping lightly from the center to the edge.

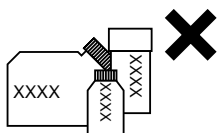

- Do not use benzine, thinner, LP record spray or other cleaners on CDs. They may damage a CD's finish.

Names of controls and parts

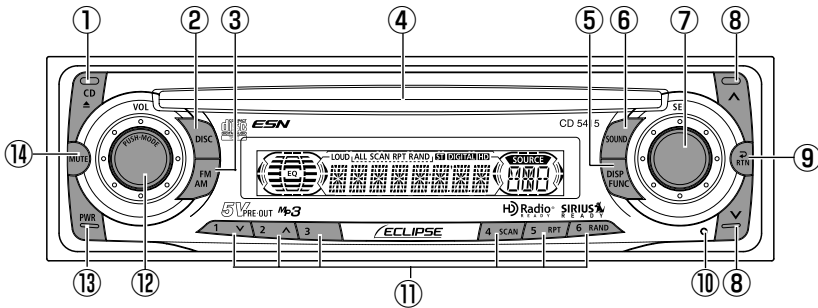

①	[CD ▲ (EJECT)] button	Ejects compact disc.
②	[DISC] button	Switches between disc modes.
③	[FM AM] button	Switches to radio mode and switches radio bands.
④	Disc slot	Inserts compact discs.
⑤	[DISP FUNC] button	Switches screen display and turns function mode ON/OFF.
⑥	[SOUND] button	Sets the equalizer settings.
⑦	[SEL] button	Selects radio stations and CD tracks.
⑧	[▲/▼] button	Automatically finds radio reception or to fast forward/rewind.
⑨	[RTN] button	Returns to previous screen.
⑩	[RESET] button	Resets deck functions to default settings.
⑪	Buttons [1] to [6]	Selects radio preset channels and performs disc mode functions.
⑫	[AUDIO CONTROL] button	Adjusts volume and performs other functions.
⑬	[PWR] button	Turns deck power ON/OFF.
⑭	[MUTE] button	Mutes or cancels muting.

ESN security operating procedure

About ESN

This deck incorporates ESN (ECLIPSE Security Network). The ESN is a security system which disables all deck functions when the power is restored if the deck is stolen from the vehicle. Once the ESN is activated, removing power to the desk or vehicle will activate the security feature.

Setting or canceling of the security feature can be done with a "Key CD". It is necessary to register a music CD as the "Key CD" in advance.

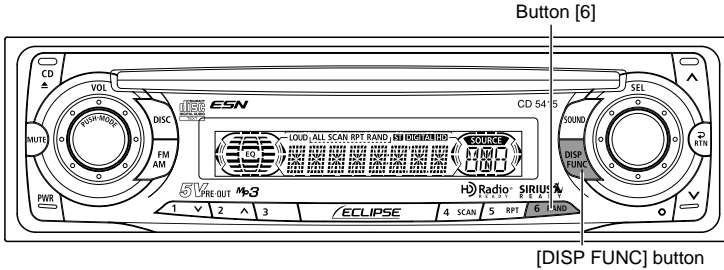

How to operate the ESN (Key CD) security

How to program the Key CD

- 1 Check that the unit is in standby.
- 2 Press and hold button [6], then the [DISP FUNC] button, and hold both for more than one second.

A [SEC] message appears, then in two seconds it will change to [DISC].

The CD5415 is now ready to accept your Key CD in the CD slot.



- If a CD has already been inserted, a [SEC] message appears, and then the CD is ejected.
- If a security is activated, programming the Key CD is not available.

- 3 Insert the CD into the slot.

A [SEC] message appears, then the Key CD is ejected.



- If there is a problem with the inserted CD, an [ERR] message will appear for two seconds and the CD will be ejected. Reinsert the ejected CD.
- If a CD causes the [ERR] message to appear twice in a row, a [CHANGE] message will appear for two seconds. Try another CD.
- Copy protected CD and MP3 CD-ROM cannot be programmed for Key CD security.
- The Security indicator will flash whenever the vehicle's ignition is switched off.

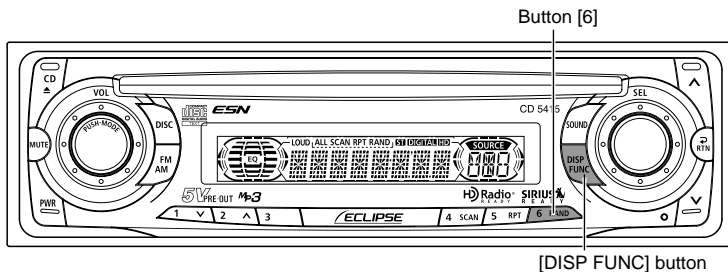

How to cancel the Key CD

- 1** Check that the unit is in standby.
- 2** Press and hold button [6], then the [DISP FUNC] button, and hold both for more than one second.

A [SEC] message appears, then in two seconds it will change to [DISC].

The CD5415 is now ready to accept your Key CD in the CD slot.



If a CD has already been inserted, a [SEC] message appears, and then the CD is ejected.

- 3** Insert your Key CD into the slot.

A [CANCEL] message appears, then the Key CD is ejected.

The Key CD is canceled.



- This process cancels the protection for the ESN deck.
- If power to the ESN deck is disconnected, then reconnected, a Key CD will not need to be inserted in order to return the unit to normal operation.
- Inserting a CD other than the Key CD will not cancel the protection. Instead, the display [ERR] for two seconds, then the normal CD playback mode will activate.

How to change the Key CD

- 1** First, cancel the existing Key CD.

Refer to "How to cancel the Key CD."

- 2** Next, program a new Key CD.

Refer to "How to program the Key CD."

How to resume normal operation (ESN security lock out)

If power is disconnected while ESN security is active (a Key CD was programmed), operation is disabled until power is restored and the unit unlocked. Follow this procedure to resume normal operation.

- 1** When the power is turned on after disconnecting the battery power, a [SEC] message will appear for two seconds. Thereafter, the message changes to [DISC] and the CD5415 is ready to accept your Key CD into the slot.

- 2** Insert your Key CD into the slot.

If the correct CD is inserted, an [OK] message will appear for two seconds and the CD will begin playing.



ATTENTION

- If an incorrect CD is inserted, an [ERR_] ("ERR" and error number) message will appear for two seconds, after which the CD will be ejected.
- If [ERR5] (the 5th time an error has occurred) appears, [HELP] will appear, after which the CD will be ejected. When [HELP] appears, carry out the operations for an ESN security lock out by following the procedure in "What happens if an incorrect CD is inserted?" (See next page).
- You must use the same CD used for Key CD programming; a duplicate CD may not work properly.

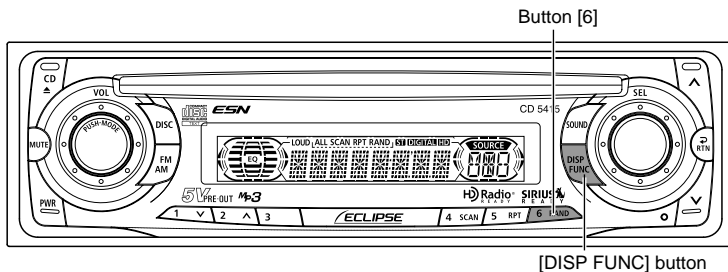

What happens if an incorrect CD is inserted?

- 1** After the 5th incorrect attempt, the display reads [HELP] for five seconds.
[HELP] will appear for five seconds, after which the serial number will appear.
- 2** Press button [6], then the [DISP FUNC] button, and hold them for five seconds.
After the [SEC] message will appear for two seconds, rolling code will appear.
- 3** Press the [DISP FUNC] button.
A [DISC] message appears.
You will have five more attempts the correct disc.
- 4** Insert your Key CD into the slot.
If the correct CD is inserted, an [OK] message will appear for two seconds and CD will be ejected.



- If an incorrect CD is inserted, an [ERR_] ("ERR" and error number) message will appear for two seconds, after which the CD will be ejected.
- This process cancels the protection for the ESN deck.

● Note ●

If after five tries the correct Key CD is not inserted, the display reads [CALL800]; the unit must be returned to Eclipse to be reset. In this case, please contact your Eclipse dealer for assistance. For country-specific customer service information, refer to "How to contact customer service" on page 93.

Your key CD can be easily forgotten. Write the album name in a reminder note (See Page 95).

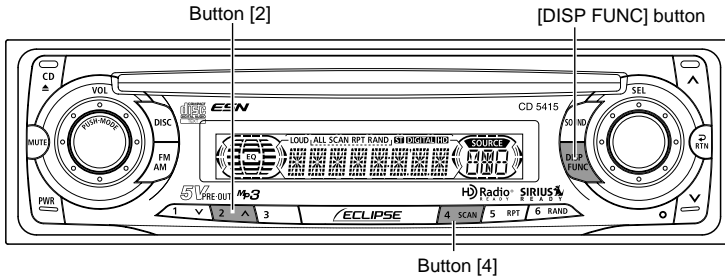

How to turn the security indicator on/off

Once ESN security is activated, the indicator flashes whenever the vehicle's ignition is turned off, warning potential thieves that the unit is protected. However, if you do not want this visible deterrent, it may be turned off.

- 1** With the unit in standby, press button [2], then the [DISP FUNC] button and hold both for more than one second.
- 2** [IND. FLASH] or [IND. -----] appears on the display.

[IND. FLASH] means the security indicator will flash when the vehicle's ignition is off, and [IND. -----] means it will not. Repeat the above steps to reactivate the flash mode.

How to read the Electronic Serial Number

- 1** Check that the unit is in standby.
- 2** Press button [4], then the [DISP FUNC] button, and hold both for more than one second.

[ESN] appears on the display, followed by an eight-digit number; this number is your electronic serial number (ESN). You may use this number to identify your Eclipse CD5415 in the event it is recovered after being stolen.

Basic operation

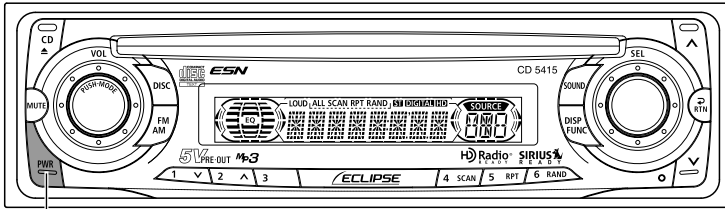

[PWR] button

This section covers basic operating procedures. For additional details, please refer to the sections on specific functions.

Turning the power on and off

Turning the power on and off.

When the power is turned on, the state used when the power was turned off such as CD and tuner playback is restored.

When the vehicle has no ACC position on the ignition switch, care is needed when turning off the deck. Follow Step 2 or Step 3 when turning off the power.

1 When power is OFF, press the [PWR] button.

The power will come ON.



When the deck's power is turned on for the first time or if the battery terminals have been disconnected because of a reason such as vehicle maintenance and the power is then turned back on, the deck will start up in FM1 mode. After this, the broadcast stations will be searched for automatically and stored in buttons [1] to [6].

2 When power is ON, press the [PWR] button for less than two seconds.

The power will go OFF and the deck will be in Standby.

If you press the [PWR] button again for more than one second, the power will go completely off.

3 When power is ON, press the [PWR] button for more than two seconds.

The power will go completely OFF.



If a car is not equipped with an ACC position (for example, a European car), keep the [PWR] button depressed for more than two seconds.

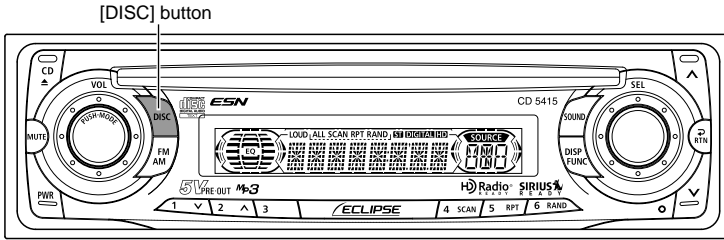

Listening to a CD

- 1 Insert a CD into the disc slot, label side up.

The CD will start playing.



When a CD is already loaded, press the [DISC] button to switch to the CD mode.

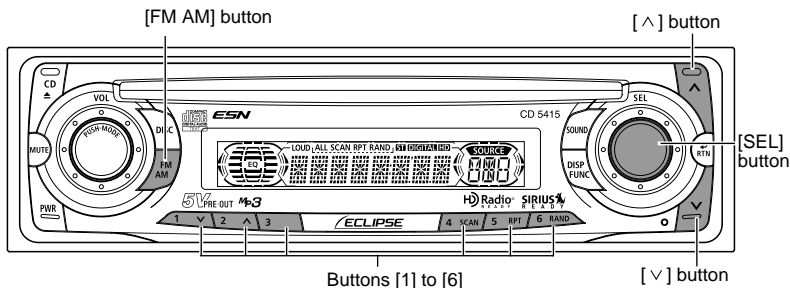

Listening to the tuner

- 1** Press the [FM AM] button.

This will turn the tuner on.
- 2** Press the [FM AM] button to switch to the desired FM or AM bands.

Radio bands will switch from FM1 → FM2 → FM3 → AM in order each time the button is pressed.
- 3** Turn the [SEL] button to the left or right to tune to a station.

Turn to the right: Tunes to higher frequencies.
Turn to the left: Tunes to lower frequencies.
- 4** Press the [^] or [v] button to start the automatic station search.

[^] button: Starts searching toward higher frequencies.
[v] button: Starts searching toward lower frequencies



- If stations have been stored in memory, pressing a button from [1] to [6] will directly select a station. (Refer to the section “Manually setting stations into memory” on page 48)
- When an optional HD Radio tuner unit is connected, digital broadcasts have reception priority. (USA only)

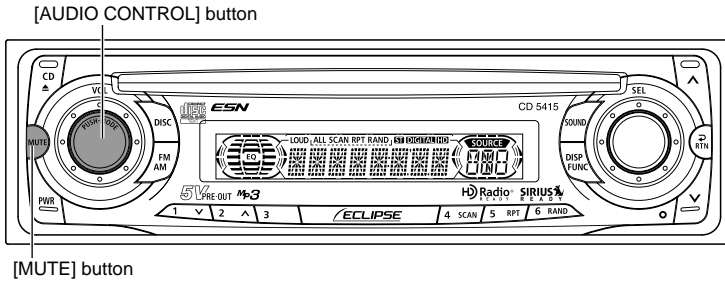

Adjusting audio volume

- 1 Turn the [AUDIO CONTROL] button to the left or right.

Turn to the right: Increases the volume.

Turn to the left: Decreases the volume.



Press the [MUTE] button for less than one second to cut the volume or restore it instantly.



Do not adjust the volume or other controls while driving the vehicle. Do so only while parked in a safe location.

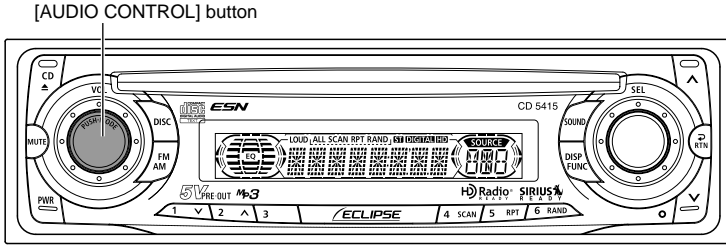

Switching audio control modes

Various audio control modes may be fine-tuned using this procedure.

- 1 Press the [AUDIO CONTROL] button for less than one second to select the item to be adjusted.

Modes will switch in the order shown below each time the button is pressed.

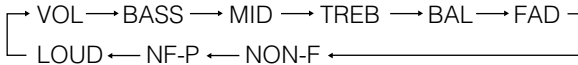

VOL (VOLUME) Mode

Adjusts volume.

Turn the [AUDIO CONTROL] button to the left or right.

Turn to the right: Increases the volume.

Turn to the left: Decreases the volume.

BASS Mode

Adjusts bass level. Bass mode can be adjusted for each source (CDP/CDC, FM and AM).

Turn the [AUDIO CONTROL] button to the left or right.

Turn to the right: Emphasizes low sounds.

Turn to the left: Softens low sounds.

MID (MIDDLE) Mode

Adjusts middle level. Mid mode can be adjusted for each source (CDP/CDC, FM and AM).

Turn the [AUDIO CONTROL] button to the left or right.

Turn to the right: Emphasizes medium sounds.

Turn to the left: Softens medium sounds.

[AUDIO CONTROL] button

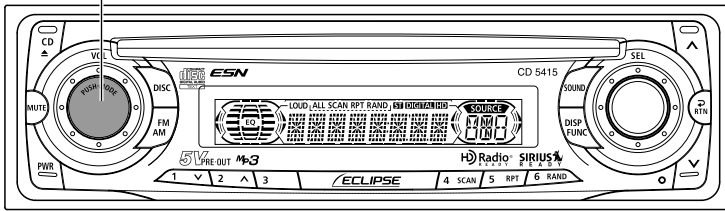

TREB (TREBLE) Mode

Adjusts treble level. Treble mode can be adjusted for each source (CDP/CDC, FM and AM).

Turn the [AUDIO CONTROL] button to the left or right.

Turn to the right: Emphasizes high sounds.

Turn to the left: Softens high sounds.

BAL (BALANCE) Mode

Adjusts left/right speaker balance.

Turn the [AUDIO CONTROL] button to the left or right.

Turn to the right: Emphasizes right speakers.

Turn to the left: Emphasizes left speakers.

FAD (FADER) Mode

Adjusts front/rear speaker balance.

Turn the [AUDIO CONTROL] button to the left or right.

Turn to the right: Emphasizes front speakers.

Turn to the left: Emphasizes rear speakers.

NON-F (NON-FADER) Mode

Adjusts non-fader level (for connected sub-woofers, etc.).

Turn the [AUDIO CONTROL] button to the left or right.

Turn to the right: Increases level.

Turn to the left: Decreases level.

[AUDIO CONTROL] button

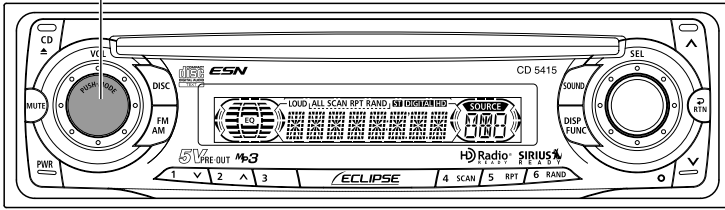

NF-P (NON-FADER PHASE) Mode

The merging of sound between the front and rear speakers and the woofer can be improved by selecting the phase.

Switch the phase to a phase which lets the speakers combine without any disharmony.

Turn the [AUDIO CONTROL] button to select NORMAL or REVERSE.

NOR: Normal phase

REV: Reverse phase

LOUD Mode

The loudness control may be turned on to emphasize low and high frequencies at low volume levels.

Loudness compensates for the apparent weakness of low and high frequencies at low volume by boosting the bass and treble levels.

Turn the [AUDIO CONTROL] button until the [LOUD ON] display appears on the screen.



To disable the loudness feature, repeat the above procedure to display the [LOUD OFF] indication.

[AUDIO CONTROL] button

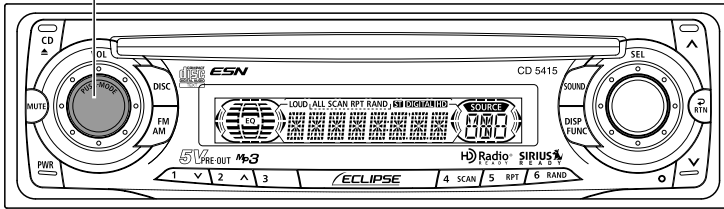

Storing user presets for the equalizer

The adjustment values for BASS, MIDDLE and TREBLE settings made in the audio control mode can be stored. The stored adjustment values can be called by changing the equalizer mode. For detail, see “Changing the equalizer mode” on page 30.

- 1** Press the [AUDIO CONTROL] button for more than one second.

The adjusted values are stored.

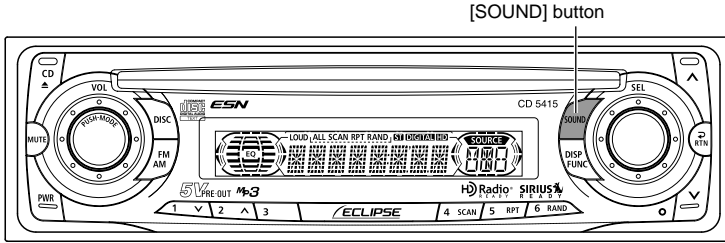

Changing the equalizer mode

EQ (equalizer) mode can be used to adjust the frequency of the audio channels being played back in accordance with the genre and instruments of the music being played.

Apart from four equalizer modes, this deck offers the audio adjustment mode in which you can store set BASS, MIDDLE, and TREBLE adjustment values, and the CUSTOM Mode in which and you can apply these adjustment values.

- 1 Press the [SOUND] button for less than one second.

Each time the button is pressed, the equalizer mode changes in the following order.

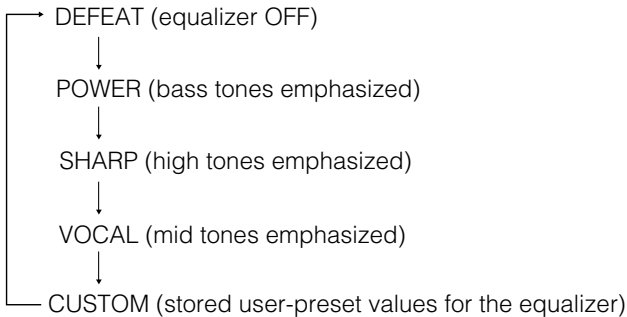

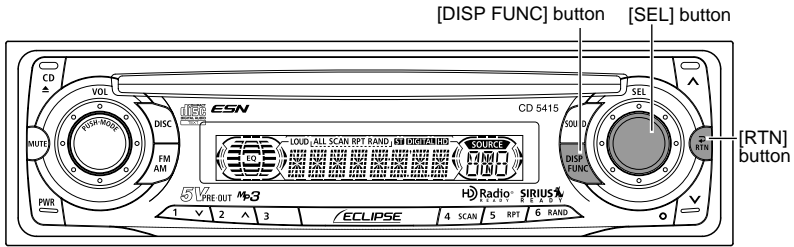

Making changes with Function Mode

A variety of settings can be changed.

- 1 Press the [DISP FUNC] button for more than one second.

The function mode is activated.

- 2 Turn the [SEL] button in either direction to display setting items for selection.

Setting items will be displayed in the following order when the [SEL] button is turned to the right.

→ BEEP → CLOCK →



ATTENTION

If the optional HD RADIO tuner is connected, the selections will switch in the following order.

→ BEEP → CLOCK → HD RADIO →

Disabling the guide tone feature (for button operation)

The receiver is set at the factory to emit a beep tone in response to button operation. The guide tone feature may be disabled in the following procedure:

- 1 Turn the [SEL] button to select BEEP.
- 2 Press the [SEL] button.
The Guide Tone Mode will be switched ON/OFF.
- 3 Turn the [SEL] button to select ON or OFF.
- 4 Press the [SEL] button to select current setting.
- 5 Press the [RTN] button.

At this time, other adjustments can also be made in Function Mode.

- 6 Press the [DISP FUNC] or [RTN] button to exit Function Mode.

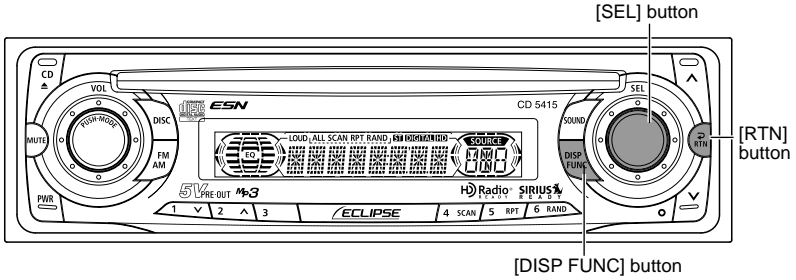

Setting the time

This receiver uses the 12-hour display notation.

- 1 Turn the [SEL] button to select CLOCK.
- 2 Press the [SEL] button.
The clock adjustment mode is activated.
- 3 Press the [SEL] button to display the item to be selected for adjustment.
Hours or minutes will be switched each time the button is pressed.
- 4 Turn the [SEL] button to the left or right.
Turn to the right: Turns the time forward.
Turn to the left: Turns the time back.
- 5 Press the [RTN] button.
At this time, other adjustments can also be made in Function Mode.
- 6 Press the [DISP FUNC] or [RTN] button to exit Function Mode.

How to operate the CD player

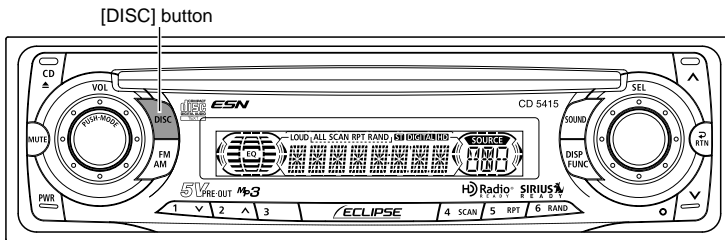

First press the [DISC] button to switch to the disc mode. It is assumed here that a CD has already been loaded into the unit.

Listening to CDs

1 Press the [DISC] button.

This starts CD play.

If an external CD changer is connected, each additional press of the [DISC] button will switch modes from CD changer 1 → CD changer 2 → CD player.

A changer or player with no discs loaded will be skipped.



- Playback may be intermittent when there is a scratch on a CD or when the recorded side is dirty.
- Only two external CD changers may be connected.

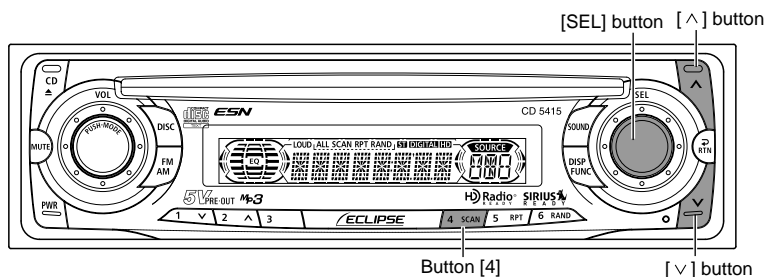

Advancing to the next track or returning to the beginning of the track being played

- 1 Turn the [SEL] button to the left or right.

Turn to the right: Advances to the next track.

Turn to the left: Returns to the beginning of the track being played. (Repeat turning for previous tracks.)

Fast Forward/Rewind

Fast forward or rewind the song currently being played.

- 1 Press and hold the [^] or [v] button.

[^] button: Fast forward.

[v] button: Rewind.

Playing the beginning of tracks (SCAN)

- 1 Press button [4].

Pressing the button causes the player to move up to the next track and play it for 10 seconds, then move up to the next track and play it for 10 seconds, and so on until the button is pressed again.



- To continue playing a desired track, press the button again to stop scanning.
- After the entire disc is scanned once, ordinary playback starts from the point where scanning started.

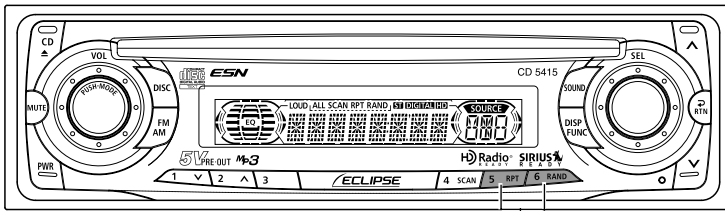

Buttons [5] and [6]

Repeating the same track (REPEAT)

- 1 Press button [5] to repeat the track being played.

To cancel, press button [5] again.

Playing tracks in random order (RANDOM)

- 1 Press button [6] to play the tracks in random order.

To cancel, press button [6] again.



- During random playback, press button [5] to repeat the track being played. To cancel repeat play (go back to random play), press button [5] again.

During playback of a particular track: The track being played is played repeatedly.

While searching: The following track is played repeatedly.

- Occasionally the same track happens to be played (selected) two or more times in a row; this is normal operation and is not a sign of a problem.
- When any of the functions - "Playing the beginning of tracks," "Repeating the same track" and "Playing tracks in random order" - is selected, a message such as [SCAN], [REPEAT] or [RANDOM] appears on the display to verify the current function.

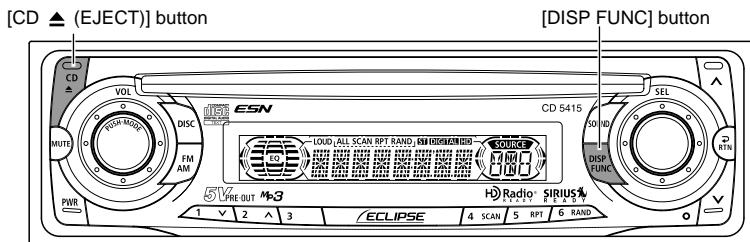

Ejecting the disc

- 1 Press the [CD ▲ (EJECT)] button.

Disc is ejected.

Displaying CD TEXT

Only the built-in CD player supports CD TEXT. It can not be displayed with the optional CD changer. If the CD came with a logo shown below, it is recorded with a disc title and track titles. These information will be displayed during playback.



- 1 Press the [DISP FUNC] button for less than one second.

Each time the button is pressed, the following will be displayed in order.

Elapsed time → Disc title/Track title* → Clock

*: The display are shows a maximum of 8 characters and then scrolls to display the remaining characters.

After the disc title is displayed, the track title will be displayed by scrolling. After the track title is scrolled the display will be fixed.

If the CD does not contain any text data, "NO TITLE" will appear.

How to operate the MP3 player

About MP3



The making of MP3 files by recording from sources such as broadcasts, records, recordings, videos and live performances without permission from the copyright holder for uses other than personal enjoyment is prohibited.

What is MP3?

MP3 (MPEG Audio Layer III) is a standard format for audio compression technology. By using MP3, a file can be compressed to one-tenth the size of the original.

This deck has limitations on MP3 file standards and recorded media and formats that can be used.

Playable MP3 file standards

- Supported standards: MPEG-1 Audio Layer III
- Supported sampling frequencies: 44.1, 48 (kHz)
- Supported bit rate: 64, 80, 96, 112, 128, 160, 192, 224, 256, 288, 320 (kbps)
 - * Supports VBR.
 - * Does not support free format.
- Supported channel modes: stereo

ID3 tags

MP3 files have an "ID3 Tag" that allows input of information so that data such as song title and artist can be saved.

This deck supports ID3v.1.0, ID3v.1.1, ID3v.2.2 and ID3v.2.3 tags.

Media

Media capable of playing MP3 includes CD-R and CD-RW discs. Compared to CD-ROM media commonly used for music discs, CD-R discs are fragile in high temperature/high humidity environments and one section of the CD-R may become incapable of playback. Fingerprints or scratches on the disc may prevent playback or cause skipping during playback. Sections of a CD-R may deteriorate if left inside a vehicle for long periods of time. It is also recommended that CD-R discs be kept in a light-blocking case because the discs are vulnerable to ultra-violet light.

Format of discs

The format of discs to be used must be ISO9660 Level 1 or Level 2.

Control items for this standard are as follows:

- Maximum directory layers: 8 layers
- Maximum characters for folder names/file names: 128 (including "." and 3 letter file extension)
- Allowable characters for folder names/file names: A~Z, 0~9, _ (underscore)
- Number of files/folders possible on a single disc: 512

[Configuration example for CD supporting MP3]

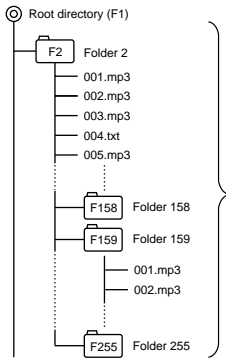

Number of files/folders possible on a single disc is 512.

Files aside from MP3 files (Example: 004.txt) also count as single files.

- Total number of folders possible on a single disc: 255
- Maximum files/folders this deck can recognize: 512*

*: A root directory is counted as one folder.

File names

Only files with the MP3 file extension ".mp3" can be recognized as MP3 and played. Be sure to save MP3 files with the ".mp3" file extension. The "MP" letters of the file extension will be recognized whether entered as uppercase letters or lowercase letters.



If the ".mp3" file extension is attached to a file other than an MP3 file, that file will be mistakenly recognized by the deck as an MP3 file and played, resulting in loud noise output that can damage the speakers. Be sure to avoid attaching the ".mp3" file extension to files that are not MP3 files.

Multi-sessions

Multi-sessions are supported, and playing of CD-R and CD-RW discs with annotated MP3 files is possible. However, when "Track at once" has been written, close the session or process the warning message. Standardize the format of each session without changing the format.

Playing MP3

When a disc with recorded MP3 files is inserted, the deck first checks all the files on the disc. No sound is output while the deck is checking the files on the disc. It is recommended that the disc be recorded without files other than MP3 files and without unnecessary folders in order to speed up the checking of disc files by the deck.

MP3 playing time display

It is possible that playing time will not be correct, depending on the writing condition of the MP3 file.

* It is possible that playing time will not be correct when VBR Fast Up/Down is operated.

Display order of MP3 file/folder names

Names of MP3 folders and files within the same level are displayed in the following order.

1. MP3 folders displayed first, by ascending order of numbers, letters.
2. Files displayed next, by ascending order of numbers, letters.

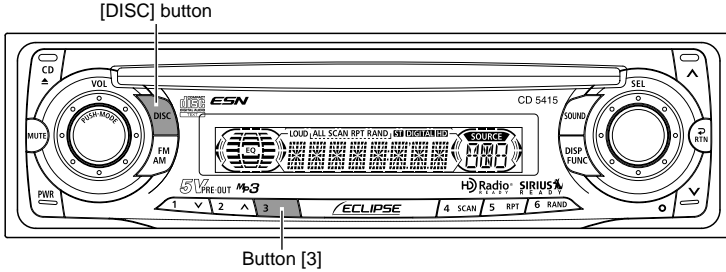

Listening to MP3 file

- 1 Press the [DISC] button.

This starts MP3 file play.

If an external CD changer is connected, each additional press of the [DISC] button will switch modes from CD changer 1 → CD changer 2 → CD player.

A changer or player with no discs loaded will be skipped.



Caution

- Playback may be intermittent when there is a scratch on a CD or when the recorded side is dirty.
- Only two external CD changers may be connected.

● Note ●

- When music data recorded in the normal way (CD-DA) is present on the same disc with MP3 music files, the normally recorded music data will be played. To listen to the MP3 music files, press button [3] for more than one second.
- When a non-MP3 file is played, [STBY ERR] will appear.
- The optional CD changer cannot be used to play MP3 files.

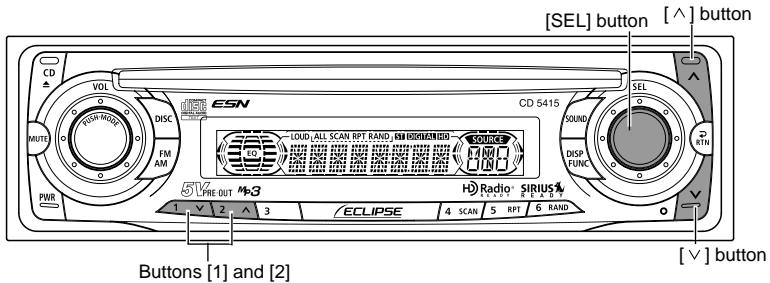

Advancing to the next track (file) or returning to the beginning of the track (file) being played

- 1 Turn the [SEL] button to the left or right.

Turn to the right: Advances to the next track (file).

Turn to the left: Returns to the beginning of the track (file) being played.

Repeat turning for previous tracks (files).

Fast Forward /Rewind

Fast forward or rewind the song currently being played.

- 1 Press and hold the [^] or [v] button.

[^] button: Fast forward.

[v] button: Rewind.

Skipping to the next or previous folder

- 1 Press button [1] or [2].

Button [1]: Selects the next lower folder.

Button [2]: Selects the next folder.

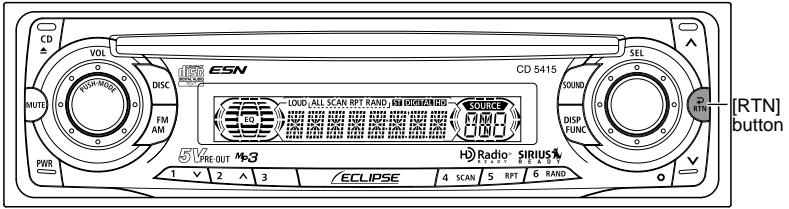

Return to the root directory of the CD

In the root directory, when a file cannot replay, the system will return to the first file that can perform a replay. (In the configuration example, the file is returning to 001.mp3. See page 38.)

- 1 Press the [RTN] button.

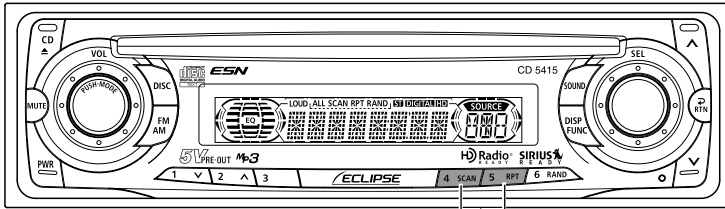

Buttons [4] and [5]

Playing the beginning of files (SCAN)

1 Press button [4].

Press the button briefly to play just the first 10 seconds of each song for all the files in the current folder being played.

Pressing the button until [ALL SCAN] is displayed will play just the first 10 seconds of the first song in each folder.



- To continue playing a desired track, press the button again to stop scanning.
- After the entire disc is scanned once, ordinary playback starts from the point where scanning started.

Repeating the same file (REPEAT)

1 Press button [5].

Press the button briefly to repeat the file being played.

Pressing the button until [ALL REPEAT] is displayed will repeat all the files in the current folder being played.

To cancel, press button [5] again.

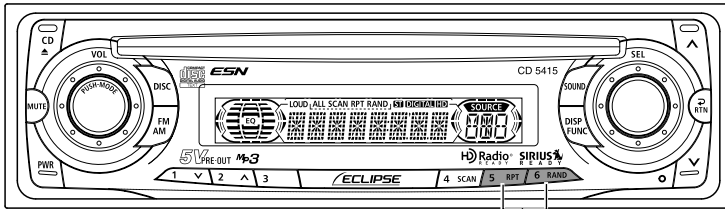

Buttons [5] and [6]

Playing files in random order (RANDOM)

1 Press button [6].

Press the button briefly to randomly play the files in the current folder being played.

Pressing the button until [ALL RANDOM] is displayed will randomly play the files in all the folders.

To cancel, press button [6] again.



- During random playback, press button [5] to repeat the file being played. To cancel repeat play (go back to random play), press button [5] again.

During playback of a particular file: The file being played is played repeatedly.

While searching: The following file is played repeatedly.

- Occasionally the same file happens to be played (selected) two or more times in a row; this is normal operation and is not a sign of a problem.

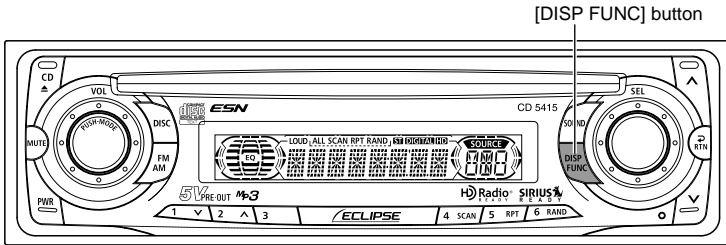

Displaying title

- 1 Press the [DISP FUNC] button for less than one second.

Each time the button is pressed the following will be displayed in order.

Folder Name/File Name*¹ → Tag*² → Folder Number/File Number → Clock → Elapsed Time

*¹: The display area shows a maximum of 8 characters and then scrolls to display the remaining characters.

After the folder name is displayed, the file name will be displayed by scrolling. After the file name is scrolled, the display will be fixed.

*²: If there is no tag data, "NO TAG" will appear.

How to operate the tuner

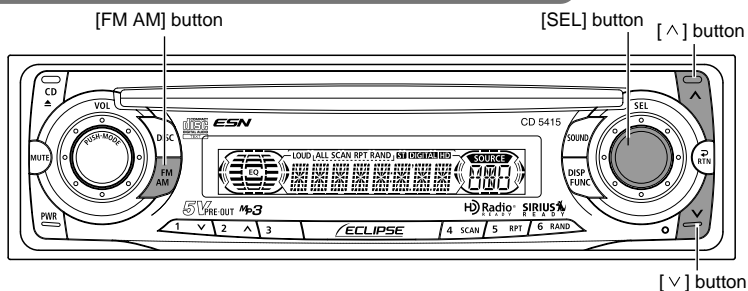

First, press the [FM AM] button to start tuner operation.

There are automatic and manual methods for setting stations in memory. The receiver will accept up to 24 stations in memory: 6 in AM and 18 in FM (6 each for FM1, FM2 and FM3.) (Initial setting)

Tuning to a station

- 1 Press the [FM AM] button for less than one second to switch to the desired FM or AM bands.

Radio bands will switch from FM1 → FM2 → FM3 → AM in order each time the button is pressed.

- 2 Turn the [SEL] button to the left or right to tune to a station.

Turn to the right: Tunes to higher frequencies.

Turn to the left: Tunes to lower frequencies.

- 3 Press the [^] or [v] button to start the automatic station search.

[^] button: Starts searching toward higher frequencies.

[v] button: Starts searching toward lower frequencies.



ATTENTION

- At times, it may be difficult to maintain optimum reception because the antenna affixed to your vehicle is in motion constantly (relative to the broadcast antenna), encountering continuous variation in the received radio signals' strength. Other factors affecting reception include interference from natural obstacles, sign posts, etc.
- When an optional HD Radio tuner unit is connected, digital broadcasts have reception priority. (USA only)

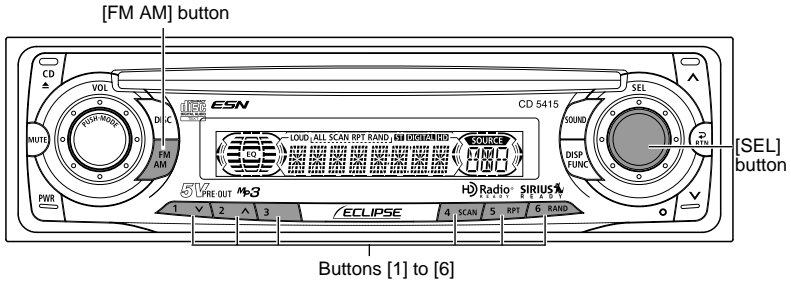

Entering stations into memory automatically (The automatic preset mode: ASM)

- 1 Press the [FM AM] button for less than one second to switch to the desired FM or AM bands.

Radio bands will switch from FM1 → FM2 → FM3 → AM in order each time the button is pressed.

- 2 Press the [SEL] button for more than two seconds until a beep is heard.

The automatic preset mode starts.

The [ASM ON] indicator on the screen flashes, and stations are automatically entered in memory under buttons [1] to [6].

These buttons are called preset buttons.



- Pressing the preset buttons ([1] to [6]) allows you to make one-touch station selections. The frequency of the selected station is indicated on the display.
- When a new station is set in memory, the station previously set in memory will be deleted.
- If there are fewer than six receivable stations, the stations set in the remaining buttons will be retained.



If the vehicle's battery is disconnected (for repairs to the vehicle or for removing the receiver), all stations in memory will be lost. In such a case, set stations in memory again.

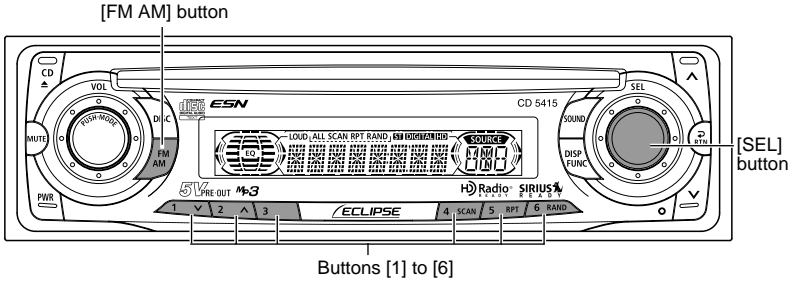

Manually setting stations into memory

This section covers the setting of stations in memory under the numbered buttons.

- 1** Press the [FM AM] button for less than one second to switch between FM and AM.
- 2** Turn the [SEL] button to the right or left to tune to the station to be entered in memory.
- 3** Select any button, from [1] to [6], and press it for more than two seconds.

The tuned station is now memorized and set in the button selected. Repeat the procedure to set additional manually tuned stations in memory, in turn, for buttons [1] to [6]. These buttons are called the preset buttons.



ATTENTION

- Pressing the preset buttons ([1] to [6]) allows you to make one-touch station selections. The frequency of the selected station is indicated on the display.
- When a new station is set in memory, the station previously set in memory will be deleted.



Caution

If the vehicle's battery is disconnected (for repairs to the vehicle or for removing the receiver), all stations in memory will be lost. In such a case, set stations in memory again.

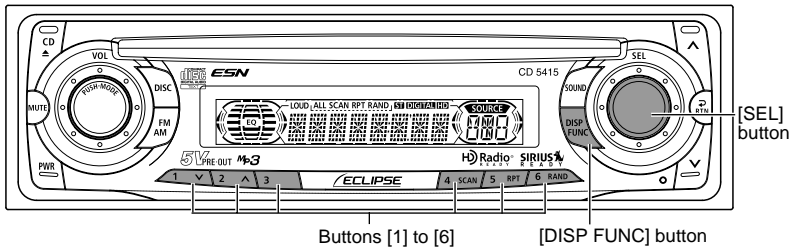

Preset station scan

This function enables reception of all the stations in the preset buttons for five seconds each.

- 1** Press the [SEL] button for less than one second.

[P SCAN] will appear on the display, and stations stored under preset buttons [1] through [6] will be played for five seconds each.
- 2** To stop the preset scan mode at a desired station, press the [SEL] button again.

The receiver will stay tuned to the desired station.

Switching the display

- 1** Press the [DISP FUNC] button for less than one second.

Each press of the button switches the display the clock and current frequency.

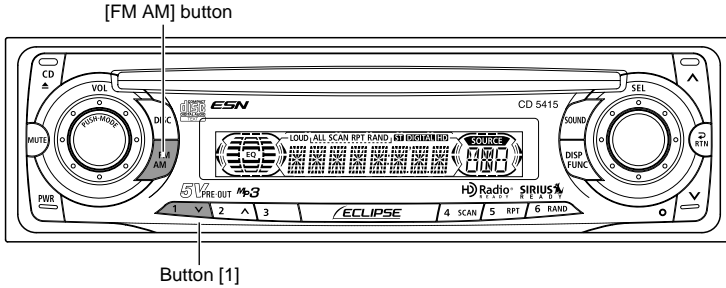

Changing the reception sensitivity for automatic scanning

The deck lets you select the reception sensitivity to be used for automatic scanning of stations. The two sensitivity modes available for this deck are AUTO mode and DX mode.



When an optional HD Radio tuner unit is connected, reception sensitivity is set to the AUTO Mode. The DX Mode is unavailable. (U.S.A. only)

<p>AUTO Mode</p>	<p>During automatic scanning, the reception sensitivity switches automatically to one of two levels. Initially the reception sensitivity is set to the low level so that only stations with strong signals are received. If no stations could be received, the reception sensitivity is increased so that stations with weaker signals can also be received.</p>
<p>DX Mode</p>	<p>Because the reception sensitivity for automatic scanning is set to the high level from the start, even stations with weaker signals can be received. (Signal crossover may result in some stations being hard to hear.)</p>

- 1** Check that the deck is in standby mode.
- 2** Press and hold the [FM AM] button, then button [1], and hold both for more than three seconds.

The mode switches between AUTO mode and DX mode each time the buttons are pressed.

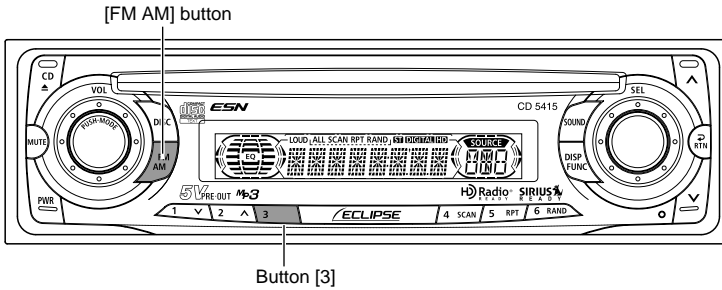

Changing the radio band location

The location for the radio bands used between the North America region and the Asia/Australia/Latin region can be switched. The default setting is USA (North America).



When an optional HD Radio tuner unit is connected, radio band location is set to USA. Other radio band locations are unavailable.(U.S.A. only)

- 1** Check that the deck is in standby mode.
- 2** Press and hold the [FM AM] button, then button [3], and hold both for more than three seconds.

The radio band switches in the order shown below each time the buttons are pressed.

→ USA → ASIA → AUS → LATIN →

After this, the broadcast stations will be searched for automatically and stored in buttons [1] to [6].

FM reception characteristics

In general, FM has much better tonal quality than AM. However, FM and FM stereo reception encounter several characteristic problems not encountered with AM. FM is more difficult to receive than AM in a moving vehicle. The following are explanatory notes on what to expect from FM reception and on how to get satisfactory performance.

FM reception differs from AM

A characteristic of transmitted signals is that lower frequencies travel further. FM frequencies are much higher than AM's (similar to a ray of light): they won't bend but they will reflect. Often, they will be interrupted by tall buildings, mountains, etc., taking direct and indirect paths to your vehicle's antenna. The distance at which FM stations can be received satisfactorily is usually not nearly as far as that which AM stations can be received.

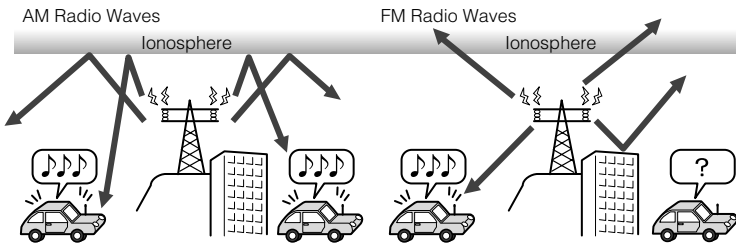

Fading out

In weak signal or “fringe” reception areas, FM stations may fade out completely, or fade in and out. When driving in weak signal areas, such as near hills, through valleys or tunnels, among tall buildings, etc., you may encounter unusual noise interference. **THIS IS NOT A TUNER PROBLEM.** In this case, you can only wait until you are in a better reception area, tune to a stronger station, or reduce the treble level.

Reception area of FM broadcasts

A home receiver can catch weak FM stereo signals through the use of a tall, directional or ultra-sensitive antenna. In a moving vehicle, the area for good reception is limited because of varying conditions encountered while driving, including the types and heights of broadcast antenna structures, signal strength, engine noise, etc. For best reception with manual antenna, extend the antenna mast as far as possible.

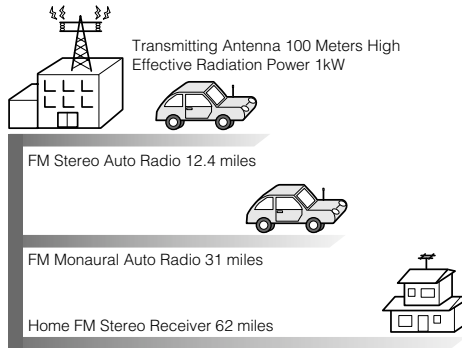

Reception quality varies depending on the power of the FM station, natural and artificial barriers, weather conditions, etc.

Multipath

The reflection characteristics of FM waves cause another problem called multipath—FM wave signals reflecting off of buildings, mountains, etc. When the antenna receives direct and reflected waves at the same time, distortion in the treble range often occurs, such as static or harsh-sounding voices. **THIS IS NOT A TUNER PROBLEM.** Only moving to another area with a clearer signal path can remedy the situation.

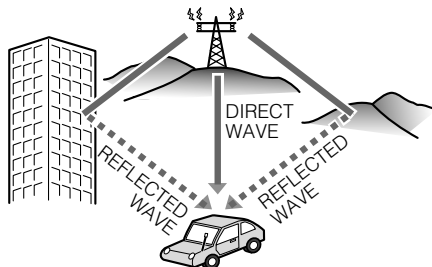

How to use an optional remote control

Precautions in use of the remote control

- Be careful when handling the remote control, especially because it is small and light. Dropping or striking it hard may damage it, wear out the battery or cause a malfunction.
- Keep the remote control free of moisture, dust and water. Do not subject it to shock.
- Do not place the remote control unit where it will get hot, such as on the dashboard or near a heater vent. Allowing the remote control unit to overheat may warp its case or cause other problems.
- Do not operate the remote control unit while driving because doing so could cause an accident.
- When using the remote control, point it directly at the remote control light receptor.
- The light receptor may not operate correctly if it is exposed to bright light such as direct sunlight.
- Be sure to press the [PWR] button on the main unit for more than two seconds to shut it down before leaving the car, or the car battery may be run down. When the main unit is shut down, the remote control will not work.
- Remove the batteries from the remote control unit whenever it is not to be used for a long time.

Cleaning the remote control

- Use a dry cloth to keep the unit clean. If the remote control unit gets extremely dirty, clean it with a cloth moistened in diluted liquid detergent. Do not use alcohol or thinner; these compounds may damage the finish.
- In no event should benzine or thinner be used. These substances will damage the case or finish.

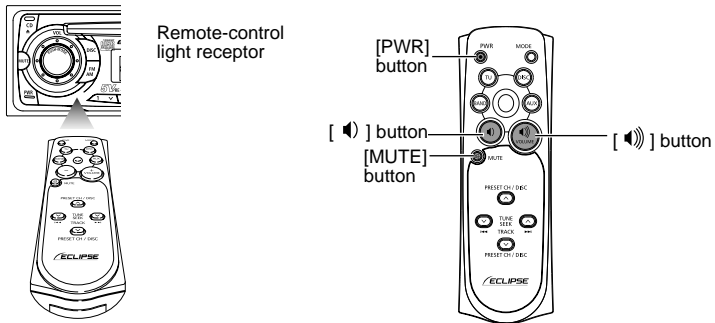

Turning the power on/off

When the power is turned on, the state used when the power was turned off such as CD and tuner playing is restored.

- 1 Press the [PWR] button.

The power turns on or off each time the button is pressed.



When the main unit is shut down, the remote control will not work.

Adjusting the audio volume

- 1 Press the [\blacktriangleright] or [\blacktriangleleft] button.

[\blacktriangleright] button: Increases the volume.

[\blacktriangleleft] button: Decreases the volume.

Muting the volume

Press the [MUTE] button to cut the volume or restore it instantly.

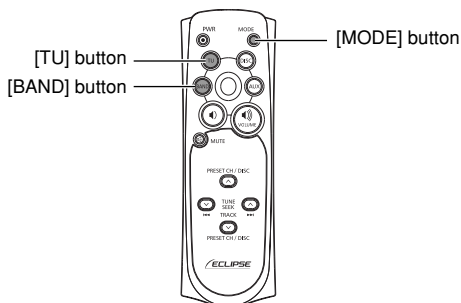

Switching playback modes

- 1 Press the [MODE] button.

Press the button to switch modes in the following sequence:

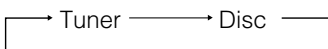

How to play the tuner

Select the tuner mode first.

Selecting the FM/AM band

- 1 Press the [BAND] or [TU] button.

Each press will switch tuner modes from FM1 → FM2 → FM3 → AM.



- It is not possible to switch between FM/AM modes and SIRIUS with the remote control.
- If the optional SIRIUS tuner is connected, the selections will switch the modes from SR1 → SR2 → SR3 → SR4 in order.

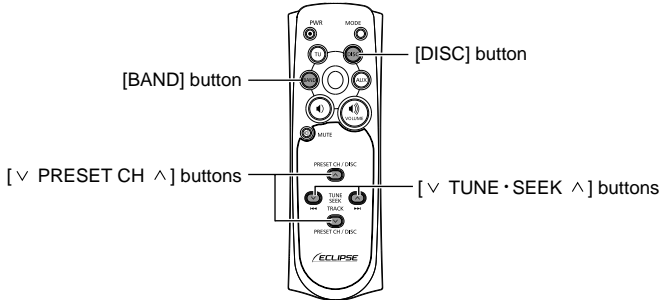

Selecting a station (manually or automatically)

A short tap of the button will allow manual station tuning. Pressing for more than one second will start automatic tuning.

- 1 Press the [∨ TUNE•SEEK ^] button.

[^] button: Tunes to higher frequency stations.

[∨] button: Tunes to lower frequency stations.

Selecting preset stations

A total of six stations may be selected (preset tuning) out of those already set in memory through the main unit. (Refer to "Manually setting stations into memory," page 48.)

- 1 Press the [∨ PRESET CH ^] button.

[^] button: Select the next higher number preset button.

[∨] button: Select the next lower number preset button.

How to play CDs

Select the disc mode first.

Switching disc mode

- 1 Press the [BAND] or [DISC] button.

When one or two CD changers are connected, press the [BAND] or [DISC] button to change modes from CD player → CD changer 1 → CD changer 2.

The indicator will skip a changer or player that has no discs loaded.

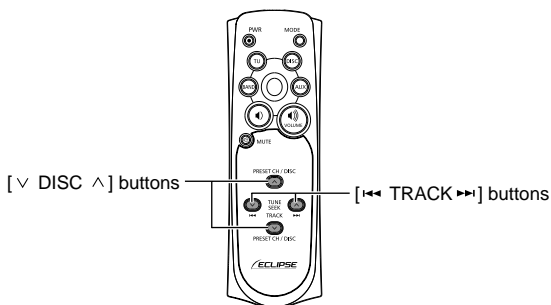

Advancing to the next track or returning to the beginning of the track being played

- 1 Press the [◀◀ TRACK ▶▶] button.

[▶▶] button: Skips to the next track.

[◀◀] button: Returns to the beginning of the track being played. (Press repeatedly to move to previous tracks.)



Hold the [▶▶] button down to fast forward, or the [◀◀] button to rewind through the track being played.

Skipping to the next or previous disc

- 1 Press the [∨ DISC ^] button.

[^] button: Selects the next higher number disc.

[∨] button: Selects the next lower number disc.

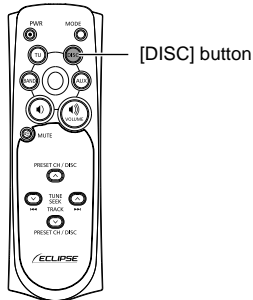

Listening to MP3 file

Switching the disc mode

- 1 Press the [DISC] button.

The disc mode changes and the disc starts playing.
 Each press will switch the modes from CD player → CD changer 1 → CD changer 2.

Any device that has no CD loaded or that is not connected is skipped.



ATTENTION

- The optional CD changer cannot be used to play MP3 files.
- If normally recorded music data (CDDA) and MP3 music files are mixed, then normally recorded music data will be played.



Caution

Playback may be intermittent when there is a scratch on a CD or when the recorded side is dirty.

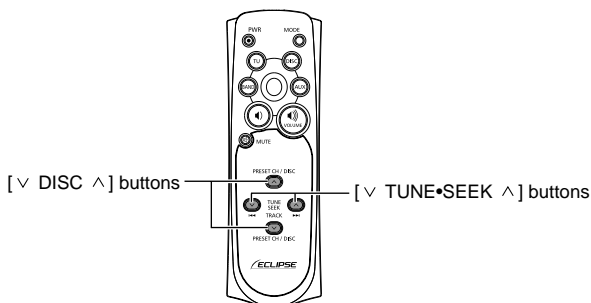

Advancing to the next file or returning to the beginning of the file being played

Advancing to the next file or returning to the beginning of the file being played.

- 1 Press the [v TUNE•SEEK ^] button.

[^] button: Advances to the next track (file).

[v] button: Returns to the beginning of the track (file) being played.

Repeat pressing for previous tracks (files).

Skipping to the next or previous folder

Skipping to the next folder or returning the previous folder.

- 1 Press the [v DISC ^] button.

[^] button: Selects the next folder.

[v] button: Selects the next lower folder.

Fast Forward /Rewind

- 1 Press and hold the [v TUNE•SEEK ^] button.

[^] button: Fast forward.

[v] button: Rewind.

Replacing the battery



Warning

To prevent accidents, store batteries out of the reach of children. If a child has swallowed one, consult a doctor immediately.

Use two AAA-size batteries.

- 1 Remove the back cover of the remote control unit by gently pressing and sliding it in the direction indicated by the arrow.

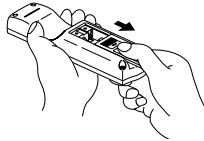

- 2 Install the two batteries provided into the compartment as illustrated inside the compartment.

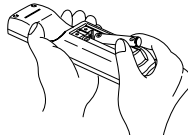

- 3 Return the back cover into place by sliding it in the direction indicated by the arrow.

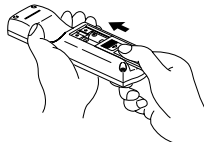

Caution

- Be extremely careful not to swallow the battery.
- The battery life is approximately one year. If the remote control unit does not operate correctly or if the button lamp gets dim, replace the batteries.
- Be sure to orient the batteries correctly so that the positive and negative poles match the diagram.
- Do not use one new battery and one old one; use two new batteries.
- Use only two of the same kind of battery.
- If any liquid is seen leaking from the batteries, remove both batteries and dispose of them properly. Thoroughly clean the battery compartment with a dry cloth. Then install new batteries.

How to operate the receiver with an optional CD changer connected

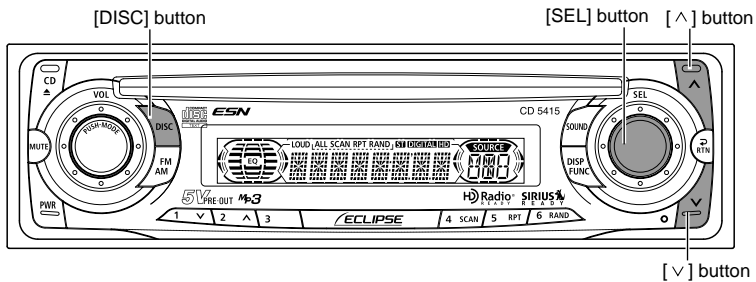

This section covers the operation of an optional CD changer that is connected to the receiver.

To switch from another mode, press the [DISC] button.

Listening to a CD

- 1 Press the [DISC] button.

Each press of the button switches the mode from CD Player → CD Changer 1 → CD Changer 2.

Advancing to the next track or returning to the beginning of the track being played

- 1 Turn the [SEL] button to the left or right.

Turn to the right: Advances to the next track.

Turn to the left: Returns to the beginning of the track being played. (Repeat turning for previous tracks.)

Fast Forward/Rewind

Fast forward or rewind the song currently being played.

- 1 Press and hold the [^] or [v] button.

[^] button: Fast forward.

[v] button: Rewind.

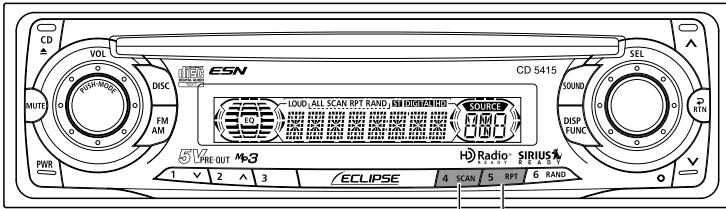

Buttons [4] and [5]

Playing the beginning of tracks (SCAN)

- 1 Press button [4].

Pressing the button causes the changer to move up to the next track and play it for 10 seconds, then move up to the next track and play it for 10 seconds, and so on, on one CD, until the button is tapped again.

Hold the button until the [ALL SCAN] display appears to play the first 10 seconds of the first track of every CD loaded.



- To continue playing a desired track, press the button again to stop scanning.
- After the entire disc is scanned once, ordinary playback starts from the point where scanning started.

Repeating the same track (REPEAT)

- 1 Press button [5].

Pressing on the button causes the changer to repeat the track currently being played, until the button is tapped again.

Hold the button until the [ALL RPT] display appears to repeat all tracks on the CD being played.

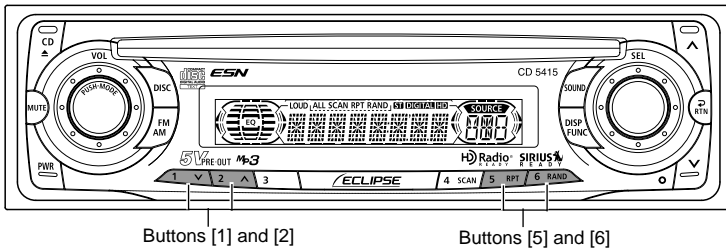

Playing tracks in random order (RANDOM)

1 Press button [6].

Pressing on the button causes the changer to play the tracks on the currently playing CD in random order, until the button is pressed again.

Hold the button until the [ALL RAND] display appears to play tracks from all of CDs loaded in the currently selected changer, in random order.



- During random playback, press button [5] to repeat the track being played. To cancel repeat play (go back to random play), press button [5] again.
During playback of a particular track: The track being played is played repeatedly.
While searching: The following track is played repeatedly.
- Occasionally the same track happens to be played (selected) two or more times in a row, but it is not a sign of a problem.
- When any of the functions - “Playing the beginning of tracks,” “Repeating the same track” and “Playing tracks in random order” - is selected, a message such as [SCAN], [ALL SCAN], [REPEAT], [ALL RPT], [RANDOM] or [ALL RAND] appears on the display to verify the current function.
- Random play is not canceled even if a magazine is ejected.

Skipping to the next or previous CD

1 Press button [1] or [2].

Button [1]: Selects the next lower number disc.

Button [2]: Selects the next higher number disc.

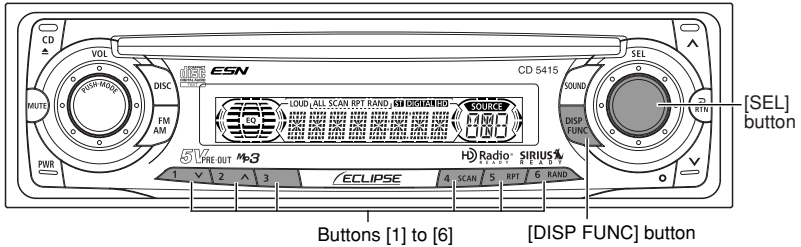

Specifying a CD to play

A CD of your choice is directly selectable out of the loaded discs.

- 1** Press the [SEL] button.
- 2** Press a button from [1] to [6].

Buttons	1	2	3	4	5	6
CD	1	2	3	4	5	6
	7	8	9	10	11	12

To select a CD from nos. 7 to 12, press the desired button considerably longer.

Switching the display

- 1** Press the [DISP FUNC] button for less than one second.

Each time the button is pressed the following will be displayed in order.

track No./elapsed time → disc No./track No. → clock.

How to operate the tuner with an optional HD RADIO tuner connected (U.S.A. only)

About HD Radio

If the optional HD Radio (High Definition Radio) tuner unit is connected, terrestrial digital broadcasts can be received. When terrestrial digital broadcasts are received, FM reception has the same quality as a CD, and AM reception has the same quality as conventional FM sound. Depending on the reception status, HD Radio can also receive analog broadcasts, which means reception is still possible in regions with no digital coverage.

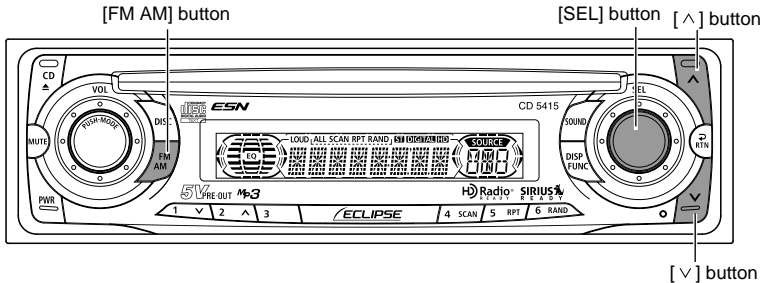

First, press the [FM AM] button to start tuner operation. There are automatic and manual methods for setting stations in memory. The receiver will accept up to 24 stations in memory: 6 in AM and 18 in FM (6 each for FM1, FM2 and FM3.) (Initial setting)

Tuning to a station

- 1 Press the [FM AM] button for less than one second to switch to the desired FM or AM bands.

Radio bands will switch from FM1 → FM2 → FM3 → AM in order each time the button is pressed.



If the optional SIRIUS satellite radio tuner unit is connected, radio mode will be switched between the satellite radio mode and FM AM radio mode by pressing the [FM AM] button for more than one second.

- 2 Turn the [SEL] button to the left or right to tune to a station.

Turn to the right: Tunes to higher frequencies.

Turn to the left: Tunes to lower frequencies.

- 3 Press the [^] or [v] button to start the automatic station search.

[^] button: Starts searching toward higher frequencies.

[v] button: Starts searching toward lower frequencies.



At times, it may be difficult to maintain optimum reception because the antenna affixed to your vehicle is in motion constantly (relative to the broadcast antenna), encountering continuous variation in the received radio signal's strength. Other factors affecting reception include interference from natural obstacles, sign posts, etc.

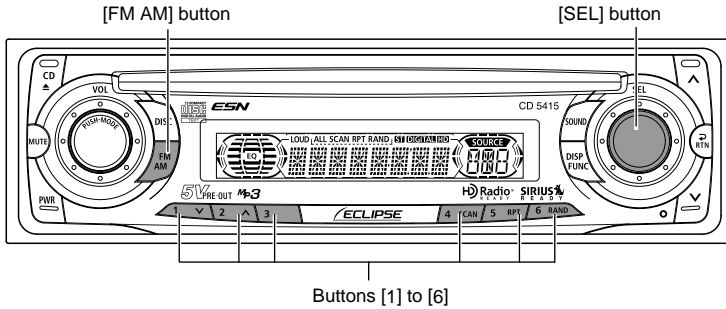

Entering stations into memory automatically (The automatic preset mode: ASM)

- 1 Press the [FM AM] button for less than one second to switch to the desired FM or AM bands.

Radio bands will switch from FM1 → FM2 → FM3 → AM in order each time the button is pressed.



If the optional SIRIUS satellite radio tuner unit is connected, radio mode will be switched between the satellite radio mode and FM AM radio mode by pressing the [FM AM] button for more than one second.

- 2 Press the [SEL] button for more than two seconds until a beep is heard.

The automatic preset mode starts.

The [ASM ON] indicator on the screen flashes, and stations are automatically entered in memory under buttons [1] to [6]. These buttons are called preset buttons.



- When a new station is set in memory, the station previously set in memory will be deleted.
- If there are fewer than six receivable stations, the stations set in the remaining buttons will be retained.

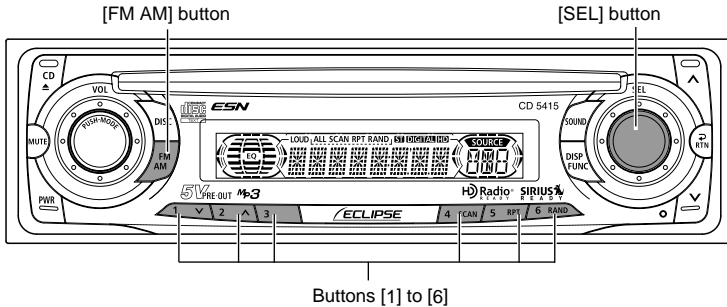

Manually setting stations into memory

This section covers the setting of stations in memory under the numbered buttons.

- 1** Press the [FM AM] button for less than one second to switch between FM and AM.



If the optional SIRIUS satellite radio tuner unit is connected, radio mode will be switched between the satellite radio mode and FM AM radio mode by pressing the [FM AM] button for more than one second.

- 2** Turn the [SEL] button to the right or left to tune to the station to be entered in memory.
- 3** Select any button, from [1] to [6], and press it for more than two seconds.

The tuned station is now memorized and set in the button selected. Repeat the procedure to set additional manually tuned stations in memory, in turn, for buttons [1] to [6]. These buttons are called the preset buttons.



If the vehicle's battery is disconnected (for repairs to the vehicle or for removing the receiver), all stations in memory will be lost. In such a case, set stations in memory again.

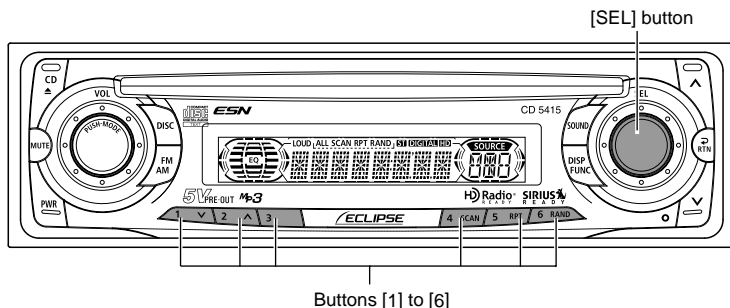

Preset station scan

This function enables reception of all the stations in the preset buttons for five seconds each.

- 1** Press the [SEL] button for less than two seconds.

[P SCAN] will appear at the display, and stations stored under preset buttons [1] through [6] will be played for five seconds each.

- 2** To stop the preset scan mode at a desired station, press the [SEL] button again.

The receiver will stay tuned to the desired station.

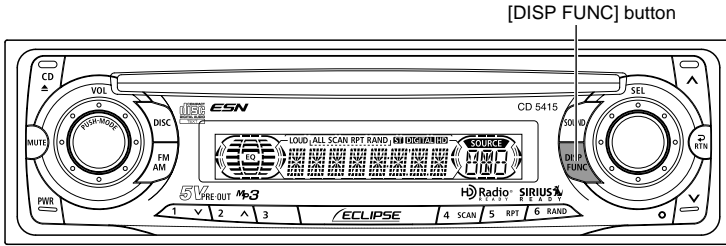

Switching between displays when receiving HD Radio

During digital reception, the name of the station being received and other information can be displayed.

1 Press the [DISP FUNC] button for less than one second.

Each time the button is pressed, the display item changes in the following order:

station name → title* → artist* → album* → genre.

* Depending on the nature of the broadcast, no information may be shown.

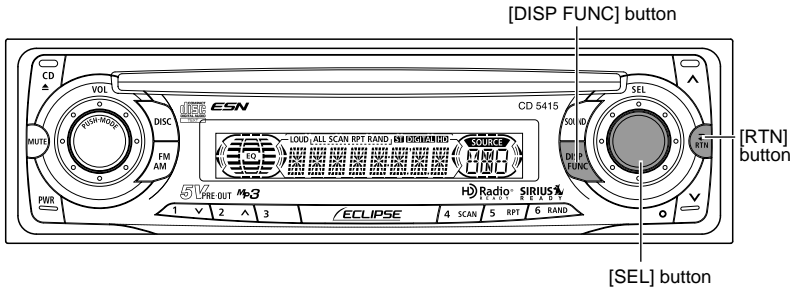

HD Radio reception settings

The HD Radio reception method can be selected. When the HD Radio tuner is connected to this deck for the first time, it will be set at [AUTO] (automatic digital/analog selection).

- 1** Press the [DISP FUNC] button for more than one second.

The function mode is activated.

- 2** Turn the [SEL] button to select HD RADIO.

- 3** Press the [SEL] button.

The mode will change to reception setting mode.

- 4** Turn the [SEL] button to select AUTO or OFF.

In the [AUTO] setting, the selection is switched between digital and analog reception automatically. In areas where digital reception is not possible, reception is automatically switched to analog to avoid loss of reception.

During digital reception, [DIGITAL] is shown on the display. This is cleared during analog reception.

In the [OFF] setting, reception is always analog.

- 5** Press the [SEL] button.

- 6** Press the [RTN] button.

At this time, other adjustments can also be made in Function Mode.

- 7** Press the [DISP FUNC] or [RTN] to exit Function Mode.

How to operate the tuner with an optional SIRIUS satellite radio tuner connected (U.S.A. only)

About SIRIUS satellite radio

If the optional SIRIUS satellite radio tuner unit is connected, satellite radio can be received.

With SIRIUS satellite radio, over 100 channels are available including music, sports, news, and entertainment programs.

The channel can be selected from categories such as POP and ROCK, or select a channel by direct input.

Reception of SIRIUS satellite radio is charged; you have to subscribe to it.

It is possible to subscribe from the SIRIUS radio website.

URL: <http://cdn.sirius.com>



For information about the operation and set-up of the SIRIUS satellite radio tuner unit, see the SIRIUS satellite radio unit's owner's manual.

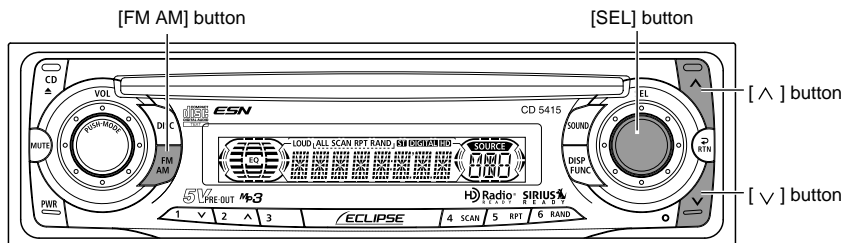

Selecting the radio mode

- 1 Press the [FM AM] button for more than two seconds.

The mode switches between satellite radio mode and FM/AM radio mode each time the button is pressed.

Tuning to a channel

- 1 Press the [FM AM] button for less than one second to switch to the desired SR channels.

Radio bands will switch from SR1 → SR2 → SR3 → SR4 in order each time the button is pressed.

- 2 Turn the [SEL] button to the left or right to tune to a channel.

Turn to the right: Tunes to higher channels.

Turn to the left: Tunes to lower channels.

- 3 Press the [^] or [v] button for less than one second to start the automatic channel search.

Reception is enabled for all channels within the currently selected category.

(Refer to page 75 for details on “Category selection”.)

[^] button: Starts searching toward higher channels.

[v] button: Starts searching toward lower channels.

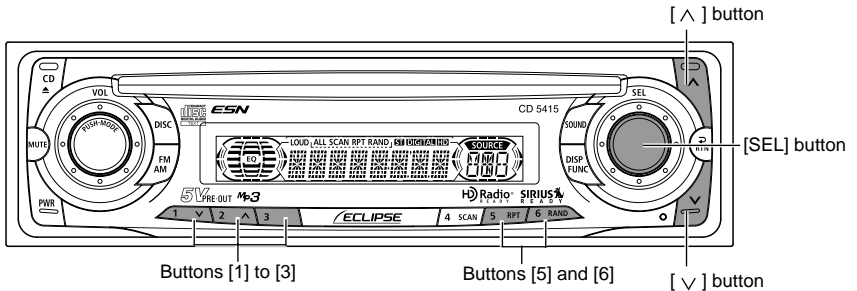

Category selection

The channel can be selected from among categories such as POP and ROCK. Consult the SIRIUS website for details of categories.

- 1 Press the [^] or [v] button for more than one second.

[^] button: Advance to next category.

[v] button: Return to previous category.

Direct channel selection

The channel can be selected by inputting the channel directly.

- 1 Press the [SEL] button for more than two seconds.

The mode will change to direct channel selection mode.

- 2 Press the buttons [1], [2] and [3] to select the channel number to be input.

[1] button : Hundreds

[2] button : Tens

[3] button : Units

Each time the buttons are pressed, the numerals change in the following order.

0 → 1 → 2 → 3 → 4 → 5 → 6 → 7 → 8 → 9

Pressing the [6] button clears the numeral at the previous digit.

- 3 Press button [5].

Starts reception.

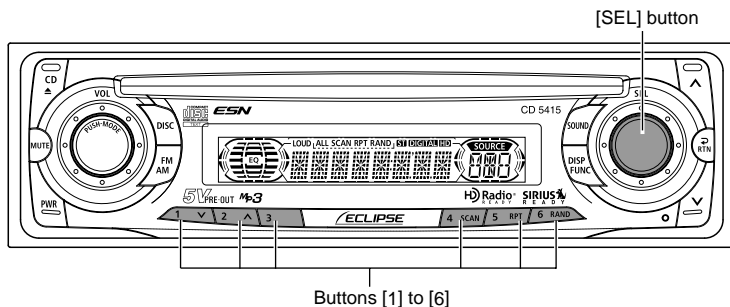

Manually setting channels into memory

This section covers the setting of channels in memory under the numbered buttons.

- 1 Turn the [SEL] button to the right or left to tune to the channel to be entered in memory.
- 2 Select any button, from [1] to [6], and press it for more than two seconds.

The tuned channel is now memorized and set in the button selected. Repeat the procedure to set additional manually tuned channels in memory, in turn, for buttons [1] to [6]. These buttons are called the preset buttons.



Warning

If the vehicle's battery is disconnected (for repairs to the vehicle or for removing the receiver), all channels in memory will be lost. In such a case, set channels in memory again.

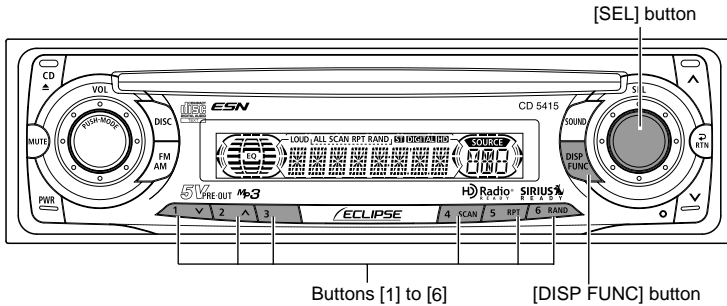

Preset channel scan

This function enables reception of all the channels in the preset buttons for five seconds each.

- 1 Press the [SEL] button for less than two seconds.

[P SCAN] will appear at the display, and channels stored under preset buttons [1] through [6] will be played for five seconds each.

- 2 To stop the preset scan mode at a desired channel, press the [SEL] button again.

The receiver will stay tuned to the desired channel.

Switching displays when using the SIRIUS satellite radio

- 1 Press the [DISP FUNC] button for less than one second.

Each time the button is pressed the display item changes in the following order:

channel name → category name → title → artist → SIRIUS unit ID.

If you have a question:

If you have a question:

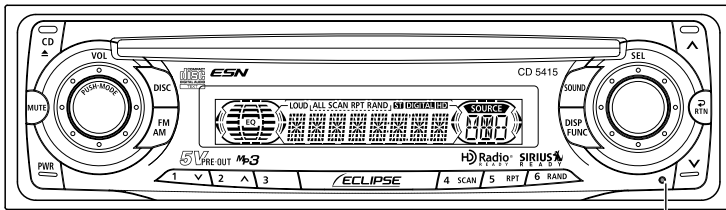

[RESET] button

First check the items mentioned below before attempting to troubleshoot problems.



Caution

If a problem occurs, for instance when the unit does not respond to any button presses, or the display doesn't work correctly, press the [RESET] button using a paper clip or similar item. Pressing the [RESET] button will delete all the entries from memory. The settings will return to those made at the factory prior to shipment.

Displayed information (for troubleshooting)

The information listed in the chart below is displayed to show the status of the CD, CD changer and SIRIUS tuner. Refer to the chart for the appropriate action.

Information Contents		Explanation and remedial action to take
INFO 2	NO DISC LOADED IN THE MAGAZINE	There is no disc in the magazine or player. Load a disc in the magazine. (Load a music disc.)
INFO 3	DISCS ARE DIRTY OR DAMAGED	The loaded disc is dirty or upside down. Check it for proper orientation and verify it is clean.
INFO 5	CD PLAYER AND CD CHANGER FAILS MECHANICALLY	<ul style="list-style-type: none"> •The CD player and CD changer is inoperative for some reason. Go through the magazine removal procedure. •If a magazine fails to eject, have your dealer fix the problem.
INFO 6	WHEN THE CD PLAYER AND CD CHANGER INTERNAL TEMPERATURE IS HIGH (TO PROTECT PICKUP UNIT)	<ul style="list-style-type: none"> •The temperature in the CD player and CD changer is too high for operation. Wait till it cools down. •Resume playing after the "High temperature sensed and CD stopped" display disappears. If the CD still cannot play, have your dealer repair it.
INFO 7	AN INTERNAL POWER SUPPLY FAILURE IS OCCURRING	<ul style="list-style-type: none"> •Turn the ACC off once before turning it on once again to resume the operation. •If the function still cannot be restricted, contact your dealer.
ANTENNA	SIRIUS ANTENNA IS DISCONNECTED	Connect the SIRIUS antenna.
CALL 888-539-SIRIUS	NO SUBSCRIPTION TO THE SELECTED CHANNEL	Subscribe to SIRIUS to receive the service by SIRIUS satellite radio.
ACQUIRING	SIRIUS SATELITE RADIO SIGNAL RECEIVING FAILS	Select another channel.
LOAD		CD changer is in the process of verifying the presence of CDs after a magazine has been inserted into the CD changer.

Mode	Problem	Causes	Remedial action to take	Refer to page
Common to all	Dead or weak sound	Is the volume control up sufficiently?	Turn up the volume control.	25
		Is MUTE functioning?	Cancel MUTE.	25
		Is the fader or balance control set far to one side?	Readjust the fader and balance controls to more normal positions.	27
		Other probable causes include broken audio-signal wiring or a faulty speaker.	Have your dealer check the problem.	—
	Power does not turn on.	Are too many electrical items installed, causing a lack of power?	Have your dealer check the problem.	—
		Other probable causes include a run-down car battery, broken power or interconnection wiring.	Have your dealer check the problem.	—
	Frequencies or titles set in memory are deleted.	Has the car battery been disconnected for repair or checked out?	Reenter them into memory.	47, 48
		Are too many electrical items installed and causing lack of available power?	Have your dealer check the problem.	—
		Other probable causes include run-down car battery, broken power or interconnection wiring.	Have your dealer check the problem.	—
	No guide tone sounds.	Is the guide tone disabled?	Enable the guide tone.	31
	The remote control does not work.	Is the battery low?	Replace battery.	61
		Is the battery installed in reverse polarity?	Reinstall the battery in the correct polarity.	61
		Is direct sunlight hitting the remote control light receptor?	Use the remote control close to the receptor.	—
		Other probable causes include a malfunctioning remote control.	Have your dealer check the problem.	—

Mode	Problem	Causes	Remedial action to take	Refer to page
CD	The disc cannot be inserted. The disc is ejected as soon as it is inserted. Or, the disc cannot be ejected. The disc cannot be changed.	Is an extra label or seal applied to the disc?	Do not apply labels or seals to the disc.	12
		Are there rough edges, deformations or damaged areas on the disc?	Try inserting another disc. Removed any burrs. Do not use a deformed or damaged disc.	13
	Sound skips around. Sound is intermittent. Sound is bad in quality.	Is the disc damaged? (scratched, warped, etc.)	Try another disc. Do not play a damaged disc.	12
		Is the disc clean?	Clean the disc.	14
		Is the player mounted at a proper angle? Is the player mounted loosely?	Have your dealer check it out.	—
		Are you driving over a rough surface?	Avoid playback while driving over rough surfaces.	11
The disc cannot be ejected.	If unknown	Press the [DISC] button a bit longer (forced Eject).	—	

Mode	Problem	Causes	Remedial action to take	Refer to page
Tuner	Receives no stations, or receives static noise.	Is the antenna retracted?	Extend the antenna.	—
		Is the tuner correctly tuned to a station?	Tune to a station.	46
		Are you driving outside the service area of your preset stations?	Tune to a local station. (Please note, there may be no local stations servicing the area where you are currently driving.)	46
		Are you operating other equipment with a computer, or a mobile phone, in your vehicle at the same time as your receiver?	Avoid operating such equipment while using the receiver.	—
		Other problems may include a loose or disconnected antenna cable, a bad antenna cable or a bad	Have your authorized Eclipse retailer check the problem.	—

Specifications

<GENERAL>

Power Supply	14.4V DC (11-16V)
Current Drain	3A
Dimensions (W x H x D)	
In-Dash Unit	7" x 2" x 6-1/8" (178 x 50 x 155mm)
Mass (weight)	Approx. 1.4kg
Usage temperature range	-20°C to + 65°C (-4°F to 149°F)
Storage temperature range	-40°C to + 85°C (-20°F to 185°F)

<FM TUNER>

Frequency Range	
USA:	87.75~107.9MHz (0.2MHz step)
Asia:	87.5~108MHz (0.05MHz step)
Australia:	87.5~108MHz (0.1MHz step)
Latin America:	87.75~107.9MHz (0.1MHz step)
Usable Sensitivity	13dBf
50dB Quieting Sensitivity	14dBf
Frequency Response	30~15,000Hz, ± 3 dB
Stereo Separation	38dB (1kHz)

<AM TUNER>

Frequency Range	
USA:	530~1,710kHz (10kHz step)
Asia:	522~1,629kHz (9kHz step)
Australia:	522~1710kHz (9kHz step)
Latin America:	530~1710kHz (10kHz step)
Usable Sensitivity	20 μ V

<CD SECTION>

Frequency Response	20~20,000Hz, ± 3 dB
Wow & Flutter	Below measurable limits
Stereo Separation	80dB
S/N Ratio (A-weighted)	95dB
Dynamic Range	95dB
Total Harmonic Distortion	0.008%

<AUDIO AMPLIFIER>

Power Output	14W x 4 (20Hz~20kHz, 1% THD, 4 Ω , Vcc=14.4V) Max 50W x 4
Output Level/Impedance	5V/55 Ω line-out impedance
Tone Action	Bass : ± 12 dB at 80Hz Middle : ± 12 dB at 630Hz Treble : ± 12 dB at 10kHz
Loudness	+10dB at 100Hz/+6.5dB at 10kHz

Before installation

● Note ●

Be sure to disconnect the vehicle battery's negative terminal before installing the receiver.

Components

No.	Item	Q'ty
1	Main unit	1
2	Mounting sleeve	1
3	Side bracket	2
4	Rear bracket	1
5	Bezel	1
6	Bushing	1
7	Self-tapping screw (6 x 16 mm)	1
8	Stud bolt	1
9	Flat head screw (red: 5 x 8 mm)	4
10	Hex-head bolt (red: 5 x 8 mm)	4
11	Hex-head bolt (6 x 20 mm)	1
12	Hex nut (5 mm)	1
13	Hex nut (6 mm)	1
14	Interconnecting cable	1

Installation angle

In order to maintain proper functioning, install the unit within an angle of 30 degrees from horizontal (standard). If this is not done, sound skipping or ejection of the CD may occur.

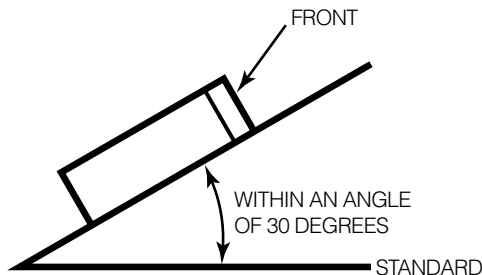

Mounting instruction

Mounting the main unit

-If installing the main unit by the mounting sleeve-

- 1** Insert the mounting sleeve into the opening in the vehicle dash board or console box.
- 2** Use a screwdriver or the like to bend the tabs in the mounting sleeve to secure the mounting sleeve.

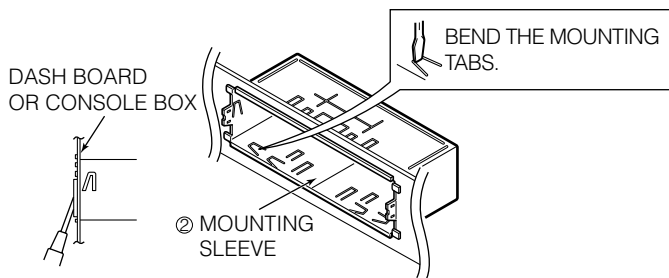

- 3** Attach the side brackets to the main unit using flathead screws.

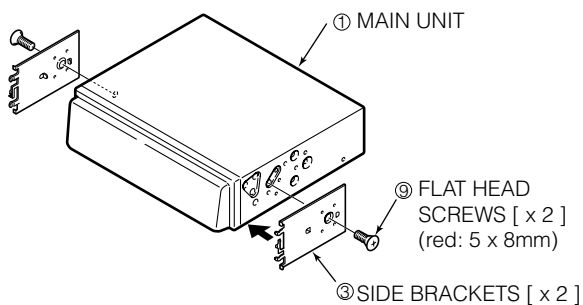

- 4** Mount the stud bolt to the main unit.
- 5** Insert the main unit into the mounting sleeve until it locks in place.
- 6** Fasten the rear of the main unit using either method [A] or [B].

Select method [A] or [B] to suit the interior configuration of the vehicle.

- 7** Install the bezel on the main unit.

[A]

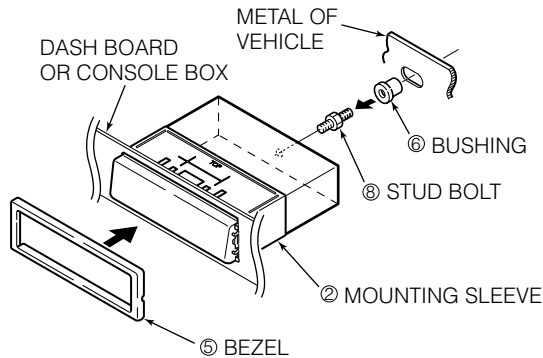

[B]

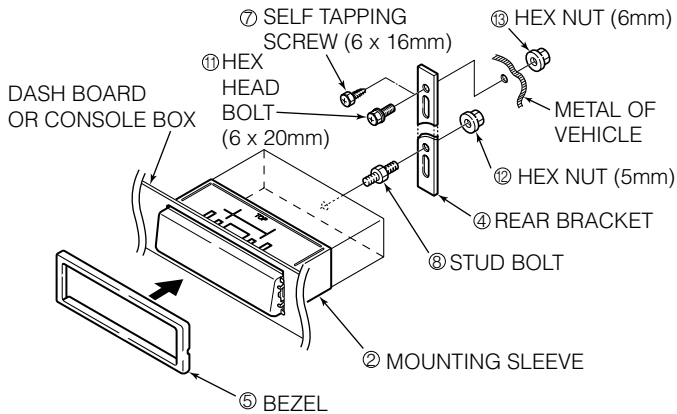

-If installing the main unit by the side brackets of the vehicle-

- 1** Remove the pocket and any other accessories from the center cluster to make room for the main unit.
- 2** Remove the mounting side brackets for the pocket.

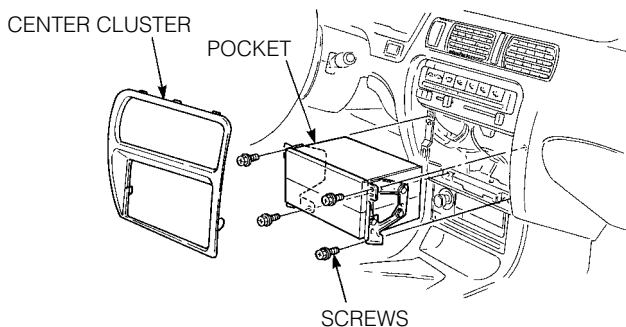

- 3** Attach the side brackets to the main unit.
- 4** Install the main unit in the vehicle.

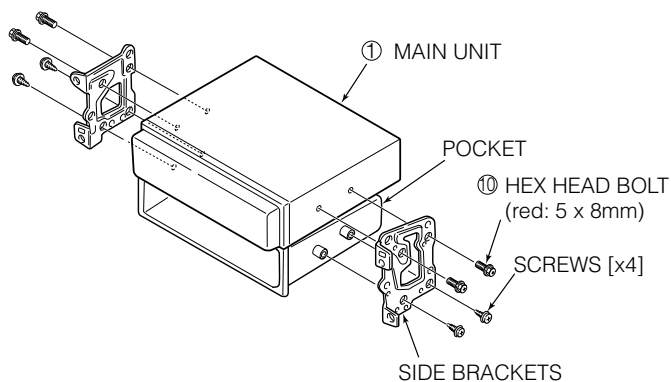

Names of lead wires and destinations (refer to Page 89)

● **Caution** ●

Never connect the power supply to the speaker leads, otherwise it cause damage to the main unit.

● **Note** ●

To prevent unconnected leads from shorting out, insulate them by wrapping their tips with electrical tape. Similarly, insulate the ends of connected leads.

If an external amplifier is to be connected to the receiver, be sure to ground its outside housing to the vehicle body (a metal part).

No.	Name	Wire color	Destination
1	ACC	Red	Connect where the power comes on when the ignition is in the ACC position.
2	B+	Yellow	Connect where the power is constantly available, regardless of the ignition switch's position.
3	Ground	Black	Connect where good body grounding is available.
4	Antenna power supply	Blue	Connect to the automatic-antenna control terminal of the vehicle.
5	Illumination power supply	Orange/White	Connect to where power comes on when the headlights are turned on.
6	Control power supply	Blue/White	Connect to the control terminal for the external amplifier, or to the RCA output connectors of a DSP or EQ.
7	E-LAN terminal		Connect to the E-LAN terminal of the CD changer, DSP, etc.
8 & 9	Line-out terminals		Connect to the RCA input connectors of an external amplifier.
10	Line-out terminals (Nonfader)		Connect to the RCA input connectors of a DSP or EQ, or the RCA connectors of a woofer amplifier.
11	Speaker leads		Connect them to their respective speaker leads.

System

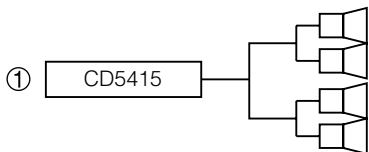

Note:
Adjust the external amplifier's input level.

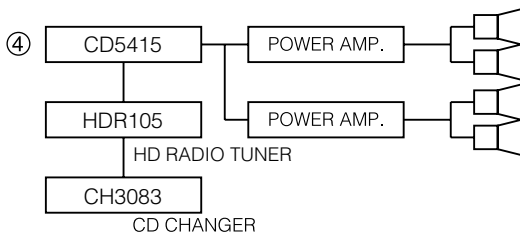
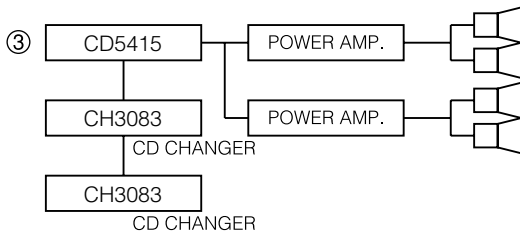
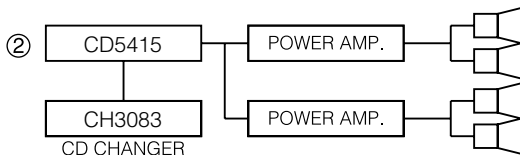

1) CD5415 Receiver, used alone

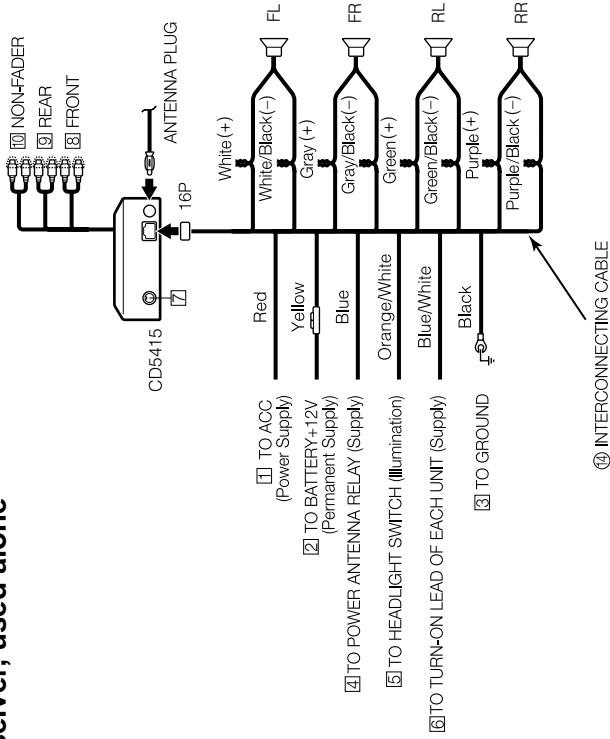

Caution

Never connect the power supply to the speaker leads, otherwise it cause damage to the main unit.

2) CD5415 + CH3083 + Power Amplifier

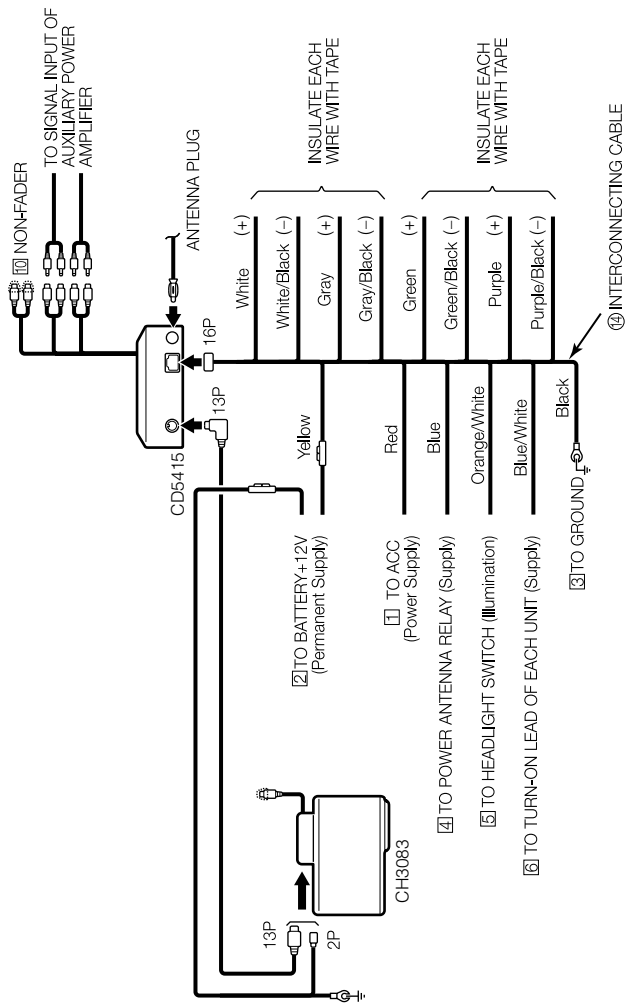

Caution

Never connect the power supply to the speaker leads, otherwise it cause damage to the main unit.

3) CD5415 + CH3083 + Power Amplifier

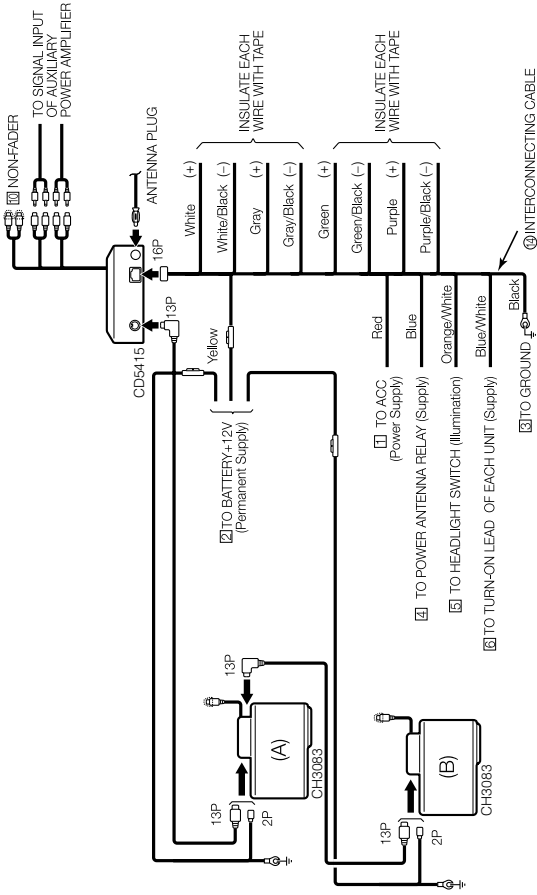

Caution

Never connect the power supply to the speaker leads, otherwise it cause damage to the main unit.

Note

1. The switch on the back side of CD changer (A) must be set the "L" position.
2. The switch on the back side of CD changer (B) must be set the "H" position.

4) CD5415 + HDR105 + CH3083 + Power Amplifier

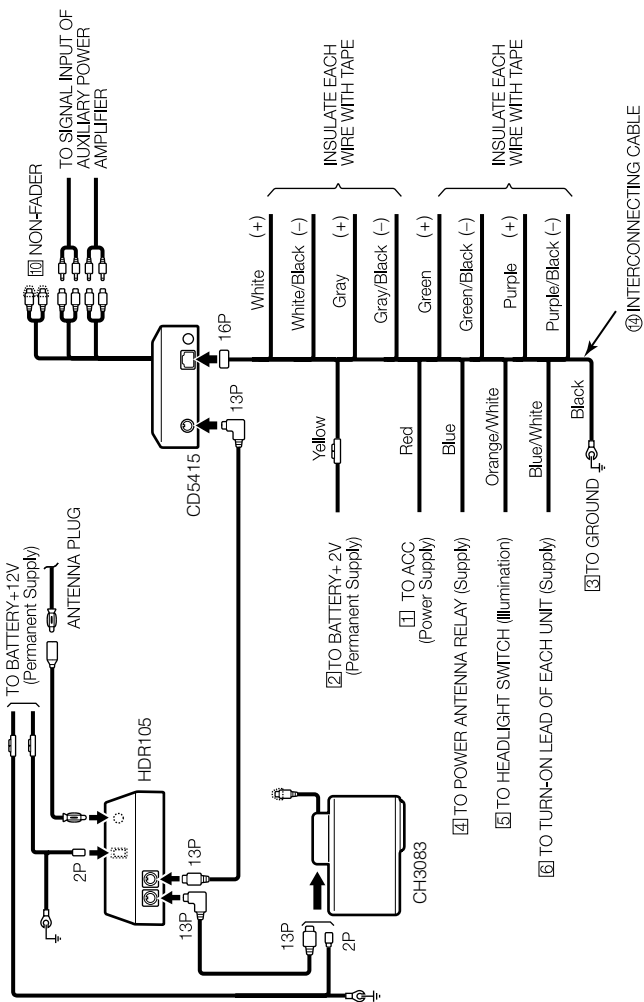

Caution

Never connect the power supply to the speaker leads, otherwise it cause damage to the main unit.

How to contact customer service

Should the product require service, please contact your nearest following Eclipse dealer.

<U.S./CANADA>

DIVISION OF FUJITSU TEN CORP. OF AMERICA
19600 SOUTH VERMONT AVENUE, TORRANCE, CA 90502
Phone: (310) 327-2151

<AUSTRALIA>

FUJITSU TEN (AUSTRALIA) PTY LTD.
ECLIPSE AUSTRALIA
Phone: 1800-211-411

<MALAYSIA>

Cobra Malaysia Sdn, bhd.
Level 5, Axis Plaza, Jalan U1/44, Glenmarie, 40150 Shah Alam,
Selangor D.E., Malaysia.
Phone: 03-5569-4200
Fax: 03-5569-4201

<SINGAPORE>

Cobra Singapore Pte Ltd
Trademart
60, Martin Road, # 05-20, Singapore 239065
Phone: 6737 2568
Fax : 6737 9538

<KOREA>

Transpectra Co., Ltd.
115-16 nonhyun dong kangnam ku Seoul, Korea.
Phone: 02-540-4595
Fax: 02-2-540-4666

HYUNDAI AUTONET Co., LTD.
1st FL. Namhyoung Bldg, 746-23 Yeoksam-Dong, Kangnam-Ku,
Seoul, Korea 135-080
Phone: 02-508-6001
Fax: 02-2-508-6067

<TAIWAN>

Sentrek Taiwan, LTD.
1, 9F, Lane 155, Section 3, Peishen RD., Shenkeng, Taipei Hsien,
222
Taiwan, R.O.C.
Phone: 02-2662-8110
Fax: 02-2662-8117

<THAILAND>

Sho-Ten Co., Ltd.
114/9 Soi Suwansawadi, Thungmahamek, Rama 4 Rd., Sathorn,
Bangkok 10120, Thailand.
Phone: 02-671-9610-12
Fax: 02-671-9614

IMPORTANT

**RECORD YOUR “KEY CD”
HERE...**

**STORE YOUR “KEY CD”
ALONG WITH YOUR
OWNER’S MANUAL
TAKE THIS OUT.**