

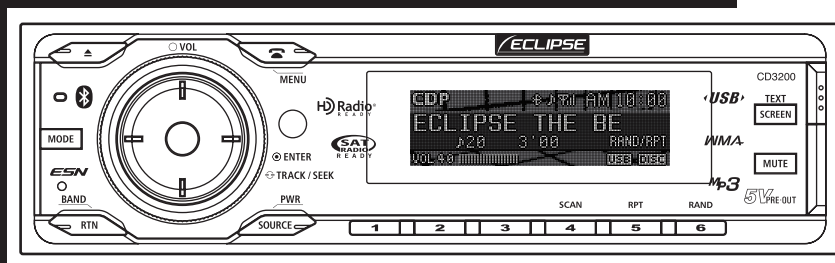

Owner's Manual / Manuel de l'utilisateur / Manual del propietario



CD3200

CD/USB Multi-Source Receiver with Bluetooth® wireless technology

We appreciate your purchase of this receiver.
Please read through this manual for correct operation.
We suggest that after reading it you keep this manual
in a safe place for future reference.

Nous vous remercions d'avoir acheté ce récepteur.
Veuillez lire ce manuel afin d'utiliser votre appareil correctement.
Nous vous recommandons de conserver ce manuel
dans un endroit sûr afin de pouvoir le consulter ultérieurement.

Tras adquirir este receptor rogamos lea atentamente su
manual para una correcta utilización del equipo.
Igualmente, guarde dicho manual en un lugar adecuado para poder
recurrir a él en caso de futuras consultas.

FUJITSU TEN

For your safety in using the CD3200

Warnings and caution signs, illustrated below, are posted throughout this manual as well as on the CD3200. They show safe and correct ways to handle the product so as to prevent personal injury to you, others and to avoid property damage.

Before reading through the manual, take time to read through and learn the important information listed in this section.



Warning

This "Warning" sign indicates a situation in which incorrect handling or disregard of this sign might result in death or serious personal injury.



Caution

This "Caution" sign indicates a situation in which incorrect handling or disregard of this sign might result in personal injury or may result solely in damage to property.

Please read all materials such as manuals and warranties that have come with the product.

Eclipse will not be held liable for unsatisfactory product performance due to failure to follow these instructions.

WARNING

- Do not modify this system for use other than that specified herein. Also, do not deviate from the installation procedures described herein; Eclipse will not be held liable for damages including, but not limited to serious injury, death or property damage resulting from installations that enable unintended operation.
- This main unit requires 12V DC and should only be installed in a vehicle with a 12V negative ground electrical system. Any other installation may cause a fire or other severe damage to the main unit and the vehicle.
- Never install this main unit where it will interfere with safe operation of the vehicle. Never block the drivers' view. Do not install main unit where it may interfere with operation of the brakes, the steering or any safety equipment, including seat belts and air bags.
- Before drilling holes in a vehicle for installation, you must confirm the locations of pipes, tanks, electrical wiring, and other vehicle systems and components to ensure that there will be no interference or contact. In addition, you must also apply rust prevention and leak prevention measures at the drilling area. Otherwise, fire or electric shock could occur.
- When installing main unit do not remove or alter existing vehicle fasteners, including nuts, bolts, screws, clips, and fittings. Never detach, move or alter existing vehicle wiring, including electrical grounds and straps. Alteration of existing vehicle components may make vehicle unsafe to operate.
- Before installation, remove the negative (-) battery terminal to prevent shocks, electrical arcing, fires, and damage to vehicle wiring and the main unit you are installing.
- Secure wiring with tape or plastic ties so that wires do not interfere with vehicle operation, including brake pedal, gear shifter and steering. Position wires so that they will not be rubbed, abraded, or damaged by moving vehicle components, including power seats.
- To avoid main unit and vehicle damage, including fire, never supply power to the installed main unit in a way which will overload the capacity of an existing vehicle circuit. Never leave a power supply wire or connection uninsulated. Always install supplied fuses, circuit breakers, and relays.

 **WARNING**

- Air bags are vital safety equipment. Never install the main unit in a way which will alter air bag wiring or interfere with air bag deployment. Air bags must function properly in the event of an accident.
- When installation is complete, test all vehicle electrical systems for proper operation, including lights, horn, brake lights, and emergency flashers.
- For your protection, never use a power drill without safety glasses or goggles. Debris or broken drill bits may cause severe eye injuries, including blindness.
- Use electrical tape to insulate the ends of all wires, even if not used. Proper insulation prevents arcs, shocks and fires.
- Some equipment or devices require the use of batteries. Never install or place this type of equipment where young children can get access to batteries. If a battery is swallowed, seek medical attention immediately.
- When vehicle is moving, never take your eyes off the road to make adjustments to the main unit. You must pay attention to the road to avoid accidents. Do not let the operation or adjustment of the main unit distract you from proper vehicle operation.
- The driver should not look at the screen while driving. Accidents may result if you are not paying attention to the forward direction.
- Do not put foreign objects in the loading slot of disc or USB input terminal. Fires or shocks may result.
- Do not disassemble or alter this main unit. Accidents, fires or shocks may result.
- Do not let water or foreign objects enter the internal parts of this main unit. Smoke, fires or shocks may result.
- Pay attention to where the remote control is left. Traffic accidents or problems with driving may result if the remote control makes its way under the foot pedals etc. when the vehicle is in motion.
- Do not use when abnormal operation occurs (the screen is not lit or no sound comes out). Accidents, fires or shocks may result.
- Always replace fuses with fuses of identical capacity and characteristics. Never use a higher capacity fuse than the original. Using incorrect fuse specifications may cause a fire or severe damage.
- If foreign objects or water enters the main unit, smoke comes out, or there is a strange odor, stop using it immediately, and contact your dealer. Accidents, fires, or shocks may result if you continue to use it in these conditions.
- The driver should not change the CD or USB memory while driving. As accidents may result if you are not paying attention to the forward direction, first stop the vehicle at a safe location and then proceed.
- Plastic bags and wrappings may cause suffocation and death. Keep away from babies and children. Never put bag over your head or mouth.

 **CAUTION**

- **Wiring and installing this main unit requires expertise and experience. Professional installation is recommended. Consult with your dealer or a professional installer. Incorrect wiring may damage the main unit or interfere with safe vehicle operation.**
- **Use only the accessory parts as specified. Using other parts may cause damage to the main unit or cause parts to dislodge and/or detach unexpectedly.**
- **Do not install the main unit in places where it may get dew condensation on (around the air conditioning hose, etc.), come in contact with water, or in condition of high moisture, dust or oily smoke. If water, moisture, dust or oily smoke enters this main unit, smoke, fires or malfunctions may result.**
- **Avoid installing in places where it cannot be fastened securely or where there are strong vibrations. Also, if you installed the main unit with double-sided tape, first wipe away dirt and wax from the installation area. Otherwise, the main unit may come loose due to vibration while driving, causing problems for driving and resulting in traffic accidents or injuries.**
- **Do not install in places with direct sunlight or where it will be hit directly by hot air from the heater. This may increase the temperature of the interior of this main unit, resulting in fires and malfunctions.**
- **Do not obstruct the air flow of the heat sink or vents of this main unit. When the air flow of the heat sink or vents are obstructed, the interior overheats, and fires may result.**
- **Connect as specified in the installation manual. If not connected normally, fires or accidents may result.**
- **When installing in vehicles equipped with air bags, check the manufacturer's cautions regarding operation to ensure proper operation of the airbags.**
- **Install wiring in a manner that will not allow them to be pinched by moving parts, damaged by screws, or damaged by metal parts. Accidents, fires and shocks may result from disconnection and electrical shorts.**
- **Avoid hot surfaces when wiring main unit. High temperatures may damage wiring, causing shorts, arcing and fires.**
- **When changing the installation location for this main unit, please consult the dealer where you bought it for safety reasons. Expertise is necessary for removal and installation.**
- **Keep volume to a reasonable level so that you can hear sounds from outside the vehicle, including warning sounds, voices, and sirens. Failure to do so may cause an accident.**
- **Be careful that hands and fingers are not pinched when closing display. Injuries may result.**
- **Do not put your hands or fingers into the loading slot of disc or USB input terminal. Injuries may result.**
- **Do not touch the heat dissipating part of the amp. Burns may result from the heat of this part.**
- **Do not recharge dry batteries. Dry batteries may rupture, resulting in injuries.**
- **Do not use batteries other than those specified. Also, do not mix old and new batteries. Injuries or pollution to the surroundings may result from battery ruptures and leakage.**

 **CAUTION**

- When inserting batteries into the remote control, be careful with the polarity (positive/negative), and insert them as indicated. If the battery polarities are incorrect, injuries and pollution to the surroundings may result from battery ruptures and leakage.
- Replace used batteries as soon as possible; they may leak and damage the remote control. Battery leakage can burn your skin or your eyes. Wash hands after handling.
- If alkaline solution from alkaline dry batteries makes contact with your skin or clothes, flush with clean water. If any of the solution gets in your eyes, also flush clean with water and then seek medical attention.
- Do not short, disassemble or heat the batteries, or place them in fire or water. Fire and injuries may result from battery rupture and leakage.
- Store the remote control in a place away from direct sunlight, high temperatures, and high moisture levels. The outer case may change shape, and the batteries may rupture and leak.
- Do not use this main unit except for in-vehicle use. Shocks or injuries may result.
- Be careful of the position of the volume when turning the power source ON. Hearing damage may result if very loud noise is emitted when the power is turned ON.
- Do not operate under abnormal conditions such as when the sound is broken or distorted. Fires may result.
- This main unit uses invisible laser light. Do not disassemble or alter this main unit. If trouble occurs, contact the dealer where you bought the main unit. Altering this main unit may cause exposure to laser emissions (worsening eyesight), or result in accidents, fires or shocks.
- If the main unit is dropped or the cosmetics appear broken, turn off the power to the main unit and contact your dealer. If used in this condition, fires or shocks may result.

Table of Contents

For your safety in using the CD3200.....	2
Operating precautions.....	14
Names of controls and parts	16
How to operate the CD/MP3/WMA player	22
How to operate the USB music file player.....	32
The Bluetooth audio function	36
How to operate the tuner.....	42
How to use the remote control	46
The Bluetooth hands-free function	48
ESN security operating procedure.....	60
How to operate the AUDIO CONTROL	64
How to operate the Sound Adjustment Mode	66
Making changes with Display Adjustment Mode.....	72
Making changes with Function Mode	76
How to operate the main unit with an optional CD changer connected.....	84
How to operate the tuner with an optional HD Radio tuner connected (U.S.A. only)	86
How to operate the tuner with an optional XM satellite radio tuner connected (U.S.A./CANADA only)	88
How to operate the tuner with an optional SIRIUS satellite radio tuner connected (U.S.A./CANADA only)	92
How to operate the main unit with an optional Interface Adapter for iPod connected	96
Others	100
If you have a question:.....	102
Specifications.....	106
How to contact customer service.....	108



Table of Contents

<i>For your safety in using the CD3200</i>	2
<i>Operating precautions</i>	14
Notes on operation	14
<i>Names of controls and parts</i>	16
Turning the power on and off.....	18
Switching Audio Modes	18
Adjusting volume	18
Switching Rotary Modes.....	19
About a shortcut	19
Creating a shortcut.....	19
Using a shortcut	20
Switching screen	20
Operation assist function	20
Detaching the front panel	21
Using the detachable panel.....	21
How to remove the detachable panel.....	21
How to attach the detachable panel.....	21
<i>How to operate the CD/MP3/WMA player</i>	22
About compact discs	22
About brand new CDs	22
About CD accessories.....	23
About borrowed CDs.....	23
How to remove CDs	23
About irregularly-shaped CDs	23
About cleaning a CD.....	23
About MP3/WMA	24
What is MP3/WMA?	24
Playable MP3 file standards.....	24
Playable WMA file standards	24
ID3/WMA tag	25
Media	25
Format of discs.....	25
File names.....	26
Multi-sessions	26
Playing MP3/WMA	26
MP3/WMA playing time display.....	26
Display order of MP3/WMA file/folder names	26
Listening to CD	27
TRACK (FILE) UP/DOWN	27
FOLDER UP/DOWN.....	28
Returning to the root directory of the CD (MP3/WMA file).....	28
FAST FORWARD/REWIND	28

SCAN/REPEAT/RANDOM	28
FOLDER SCAN/REPEAT/RANDOM	29
DISPLAYING TITLE	29
Ejecting the disc	30
<i>How to operate the USB music file player</i>	32
About playable USB memory standards	32
Playable MP3 file standards	32
Playable WMA file standards	32
Format of USB memory	33
How to operate the USB music file player	34
Listening to music files in USB memory	35
Disconnecting USB memory	35
<i>The Bluetooth audio function</i>	36
About the Bluetooth audio function	36
About the Bluetooth specifications	36
Supported Bluetooth specifications	36
Supported profile	36
What is Bluetooth?	37
Listening to music	37
Stopping the music	37
Pausing the music	37
Selecting the music you want to listen to	38
Fast forward/rewind	38
Bluetooth audio setup	38
Displaying the BT Audio Set selection mode	38
Switching the Bluetooth audio mode on and off	38
Connecting the main unit and the portable device	39
Disconnecting the main unit and the portable device	39
Displaying device information for the main unit	40
<i>How to operate the tuner</i>	42
Listening to the tuner	42
Tuning to a station	42
Operations during rotary mode	42
Automatically storing stations into memory. (The automatic preset mode: ASM)	43
Manually storing stations into memory	43
Preset station scan	43
Changing the reception sensitivity for automatic scanning	44
Changing the radio band location	44
<i>How to use the remote control</i>	46
Precautions in use of the remote control	46
Cleaning the remote control	46
Replacing the battery	47

<i>The Bluetooth hands-free function</i>	48
About the Bluetooth hands-free function	48
About the Bluetooth specifications	48
Supported Bluetooth specifications	48
Supported profile	48
What is Bluetooth?	49
Selecting the Bluetooth hands-free mode	49
Making a call	49
Making a call by dialing a phone number	49
Making a call using preset dial	50
Making a call using the incoming/outgoing call history	50
Making a call using the phonebook	51
Making a call from the cell phone	51
Receiving a call	51
Hanging up (refusing a call)	51
Adjusting the volume	51
Adjusting the ring tone volume	51
Adjusting the voice volume	52
Storing phone numbers in preset dial	52
Setting the Bluetooth hands-free function	52
Displaying the Phone Setting selection mode	52
Registering a cell phone	53
Delete a registered cell phone	54
Connecting a registered cell phone	54
Disconnecting a cell phone	55
Registering phone number in the phonebook	55
Setting Auto Answer	56
Setting the ring tone	56
Setting Auto Answer for registered cell phones	56
Displaying device information for the main unit	57
Enabling phone numbers to be input directly	57
Deleting data	57
Changing the passcode	58
 <i>ESN security operating procedure</i>	 60
About ESN	60
How to operate the ESN (Key CD) security	60
How to program the Key CD	60
How to cancel the Key CD	60
How to change the Key CD	61
How to resume normal operation (ESN security lock out)	61
What happens if an incorrect CD is inserted?	61
How to turn the security indicator on/off	62
How to read the Electronic Serial Number	62
 <i>How to operate the AUDIO CONTROL</i>	 64
Switching audio control modes	64

How to operate the Sound Adjustment Mode	66
About Sound Adjustment Mode	66
About parametric EQ	67
About position selector	67
About crossover	68
Switching the sound adjustment mode	69
Parametric equalizer adjustment (PEQ)	69
Setting preset EQ	69
Adjusting the median frequency and the Q curve	69
Position selector	70
Crossover adjustment (X-Over)	70
Non-fader phase (Non-F Phase)	71
Making changes with Display Adjustment Mode	72
Switching the Display Adjustment Mode	72
Switching the brightness (Bright)	72
Changing illumination color	72
Changing display type (DISP Type)	73
Changing Background (Background)	73
Changing the sound meter (Sound Meter)	73
Importing display data (DISP Data)	74
Changing the scroll type (Scroll Type)	75
Making changes with Function Mode	76
Switching the Function Mode	76
Setting a station name/disc title	76
Deleting a station name/disc title	77
Setting the guide tone	77
Setting clock display (Clock ON/OFF)	77
Setting time (Clock Adjust)	78
Switching demonstration screen display (Demo)	78
Setting the steering remote function (U.S.A. only)	79
Reading steering remote data (U.S.A. only)	79
How to operate the main unit with an optional CD changer connected	84
Listening to a CD	84
Advancing to the next track or returning to the beginning of the track being played	84
Operations during rotary mode	84
Fast Forward/Rewind	84
Playing the beginning of tracks (SCAN)	84
Repeating the same track (REPEAT)	85
Playing tracks in random order (RANDOM)	85
Skipping to the next or previous CD	85
Specifying a CD to play	85

<i>How to operate the tuner with an optional HD Radio tuner connected (U.S.A. only)</i>	86
About HD Radio.....	86
Switching between displays when receiving HD Radio.....	86
HD Radio reception settings.....	86
<i>How to operate the tuner with an optional XM satellite radio tuner connected (U.S.A./CANADA only)</i>	88
About XM satellite radio.....	88
Selecting the radio mode.....	88
Selecting a channel	88
Operations during rotary mode	89
Category selection	89
Direct channel selection	89
Manually setting channels into memory	89
Preset channel scan	90
Switching displays when using the XM satellite radio	90
Displaying the XM ID	90
<i>How to operate the tuner with an optional SIRIUS satellite radio tuner connected (U.S.A./CANADA only)</i>	92
About SIRIUS satellite radio.....	92
Selecting the radio mode.....	92
Selecting a channel	92
Operations during rotary mode	92
Category selection	93
Direct channel selection	93
Manually storing channels into memory	93
Preset channel scan	93
Switching displays when using the SIRIUS satellite radio.....	94
Displaying the SIRIUS ID	94
<i>How to operate the main unit with an optional Interface Adapter for iPod connected</i>	96
Listening to iPod music files (If an iPod is not connected)	96
Listening to iPod music files (If an iPod is connected)	96
Advancing to the next music file or returning to the beginning of the music file being played	96
Fast forward/rewind	96
Searching for a music file	97
Repeating the same music file (REPEAT).....	98
Playing music files in random order (SHUFFLE).....	98
Displaying text	98

Others.....	100
Connecting a portable audio player to the AUX jack	100
Switching the AUX mode on and off	100
Switching the input system.....	100
Changing auxiliary input sensitivity	101
 If you have a question:	 102
Displayed information (for troubleshooting).....	102
When you think there is a malfunction.....	104
 Specifications.....	 106
 How to contact customer service.....	 108

* For more information on the operation of E-ISERV (Area Shot, display data, steering remote), refer to the ECLIPSE Website given below and download the operation manual. (URL:<http://www.e-iserv.jp>)

Operating precautions

<Your CD3200 will perform well over a long period of time through correct handling and care.>

Notes on operation

- For your safety, play only at volume levels that allow outside sounds to be heard.



- Discs with the logo shown to the left can be played.
- You can play music CDs (CD-R/CD-RW) on this player. Be sure to use discs that have been properly processed. Depending on the editing format and software used, some discs may not play properly.

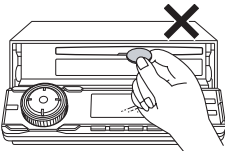

- Do not insert anything other than a CD into the main unit. Do not insert any foreign objects, such as coins or credit cards, into the disc slot.



- Avoid severe mechanical shock. When the player is subjected to severe vibration while traveling over a rough surface, playback may be intermittent. When a situation like this occurs, resume playback after returning to a smoother road.



- About dew condensation. In cold or rainy weather, just as the interior glass surface gets fogged, dew (water condensation) may also settle on the main unit. When this occurs, disc playback may become intermittent or impossible. Dehumidify the air in the vehicle for a while before resuming playback.

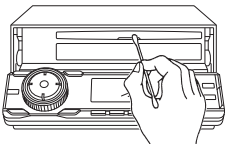

- Cleaning the disc slot. The disc slot tends to get dusty. Clean it occasionally to prevent accumulated dust from scratching the discs.



MEMO

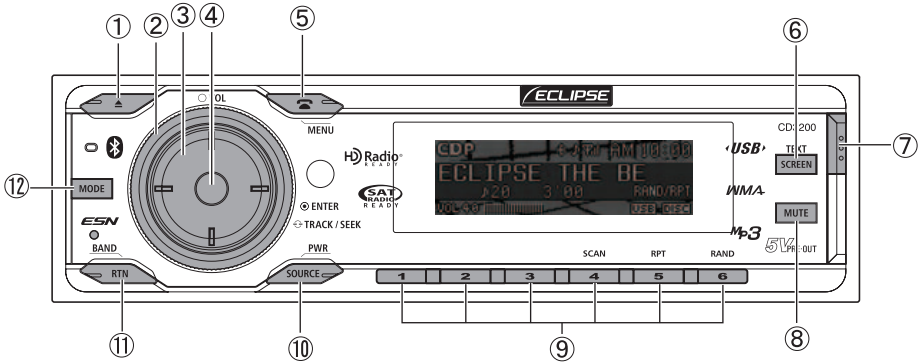

Names of controls and parts

Front view

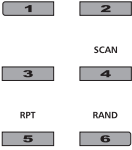

No.	Button	Name/Working
①		[▲ (OPEN/EJECT)] button Opens/closes front panel and ejects CD.
②		[VOL] button Adjusts volume.
③		[SELECT] button Selects radio station and CD tracks. Selects setting items.
④		[ENTER] button Enters selected item.
⑤		[☎/MENU] button Switches to the [TEL] mode. Switches to the Menu Selection mode.
⑥		[SCREEN/TEXT] button Switches the screen pattern. Switches the title display.

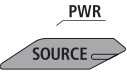
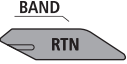
No.	Button	Name/Working
⑦		[Release] button Detach the right end of the front panel from the body of the main unit.
⑧		[MUTE] button Activates and deactivates mute.
⑨		Buttons [1] to [6] Selects radio preset channels and performs disc mode functions.

No.	Button	Name/Working
⑩		[SOURCE/PWR] button Switches audio mode. Turn the power on or off.
⑪		[RTN/BAND] button Returns to previous screen. Switches radio band.
⑫		[MODE] button Switches to rotary mode.

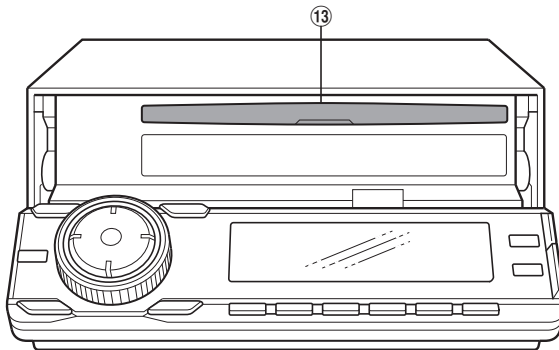

No.	Name/Working
⑬	Disc slot Inserts compact discs.

⚠ CAUTION

Never place an object or rest your hands or the like on the front panel.

Turning the power on and off

When the power is turned on, the state used when the power was turned off such as CD and tuner playback is restored.

When the vehicle has no ACC position on the ignition switch, care is needed when turning off the main unit. Follow Step 2 or Step 3 when turning off the power.

1 Press the [SOURCE/PWR] button while the power is OFF.

The power will come ON.



ATTENTION

When the main unit's power is turned on for the first time or if the battery terminals have been disconnected because of a reason such as vehicle maintenance and the power is then turned back on, the main unit will start up in FM1 mode. After this, the broadcast stations will be searched for automatically and stored in buttons [1] to [6].

2 Press the [SOURCE/PWR] button while the power is ON, for more than one second, until you hear a beep.

The power will go OFF and the main unit will be in Standby.

If you press the [SOURCE/PWR] button again for more than two seconds, the power will go completely off.

3 While the power is ON, press and hold the [SOURCE/PWR] button until the "ACC OFF" message is displayed.

The power will go completely OFF.



ATTENTION

If the vehicle does not have an ACC position, press the [SOURCE/PWR] button until the "ACC OFF" message is displayed.

Switching Audio Modes

1 Press the [SOURCE] button for less than one second.

Press the button to switch mode in the following sequence:

FM/AM → SIRIUS*¹ → XM*¹ →
 CD (MP3/WMA)*² → CDC*¹ → USB*² →
 AUX*³ → iPod*¹ → BT-Audio*³ → FM/AM → …

*1: Cannot be selected if the corresponding device is not connected to the main unit.

*2: Not displayed if no disc is inserted.

*3: Cannot be selected if the AUX mode or the BT-Audio mode is not set to ON. For details, refer to "Switching the AUX mode on and off" on page 100 or refer to "Switching the Bluetooth audio mode on and off" on page 38.

Adjusting volume

1 Turn the [VOL] button to the left or right.

Turn to the right:
Increases the volume.

Turn to the left:
Decreases the volume.



ATTENTION

Press the [MUTE] button for less than one second to mute the sound or restore it.



CAUTION

Do not adjust the volume or other controls while driving the vehicle. Do so only while parked in a safe location.

Switching Rotary Modes

The [VOL] button can be switched to other functions. When the rotary mode is set to ON, you can switch from the volume adjustment function to the following functions by pressing the [VOL] button.

Source	Function	Page
FM/AM	TUNE UP/DOWN	42
XM	TRACK UP/DOWN	89
SIRIUS	TRACK UP/DOWN	92
CDP/CDC	Track search	27
MP3/WMA	FILE search	27
USB	FILE search	27
iPod	Track search	97

For detailed information on the above functions, see the operation instructions for each related audio source.

1 Press the [MODE] button while the main unit is set to any audio mode.

Rotary mode will switch ON. When rotary mode is set to ON, the rotary indicator will be displayed as follows.

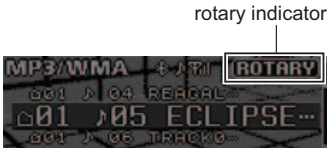

If the [MODE] button is pressed again, or if no operations are performed for more than 10 seconds, the rotary mode will be cancelled.

About a shortcut

Create a shortcut for frequently-used functions so that they can be recalled with a single operation.

Creating a shortcut

A shortcut can be created for one of the following MENU mode adjustment functions: sound adjustment mode, display adjustment mode, or function mode.

1 Switch to the mode that you want to create a shortcut for.

See the explanation for each adjustment mode for more information on switching them.

- Sound Adjustment Mode: Page 69
- Display Adjustment Mode: Page 72
- Function Mode: Page 76

2 Press the [MENU] button for more than one second.

A shortcut will be created. If the [MENU] button is held for less than one second, the previously set adjustment function will be restored.

ATTENTION

- If you attempt to create a shortcut for a hierarchy where this is not possible, the system will beep twice when the [MENU] button is pressed for more than one second.
- Depending on the audio mode and the system setting, it may not be possible to operate the shortcut function. In this case, the system will beep twice when the [MENU] button is pressed.
- Only one shortcut function can be registered. If a shortcut has already been registered, its key will be deleted when a new shortcut is created.

Using a shortcut

- 1 Press the [MENU] button for more than one second.

The Menu Selection mode will be activated.

- 2 Press the [SELECT] (Up/Down) button to select SHORTCUT.

- 3 Press the [ENTER] button.

The mode for the shortcut created will be displayed.



Switching screen



The screen's display pattern can be switched.

- 1 Press the [SCREEN/TEXT] for less than one second.

When the button is pressed, the screen pattern changes display type in the following order.

Motion picture → Motion picture off → Sound Meter → Display off → Motion picture → …

Pattern	Display
Motion picture 	Displays a screen showing the moving image set in display adjustment mode (refer to page 73) and information such as elapsed CD playing time and current audio mode status.
Motion picture off 	Displays a screen showing information such as elapsed CD playing time and current audio mode status.

Pattern	Display
Sound Meter 	Displays the Sound Meter set in display adjustment mode (refer to page 73).
Display off 	Displays a black screen.

Operation assist function

In menu mode, the screen displays help to guide you in carrying out operations.



The function button selected for adjustment is displayed.

Detaching the front panel

Using the detachable panel

The front panel of the main unit can be removed.

By removing this panel when you leave the vehicle, you can prevent the theft of the main unit.

How to remove the detachable panel

1 Press the [Release] button.

The right end of the front panel detaches from the body of the main unit.

2 Detaching the front panel

Hold the front panel and pull it toward you to remove it.

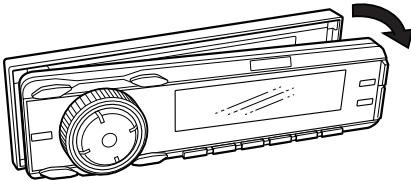

3 Put the front panel into the case.

Push to open the front panel case and put the front panel in it.

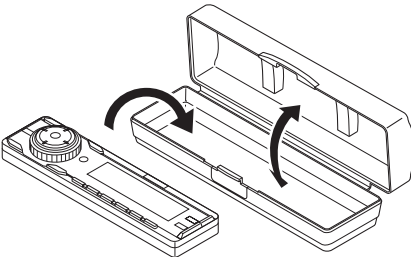

How to attach the detachable panel

1 Insert the left end of the front panel into the main unit.

Engage the catch at the left end of the front panel with the lock on the main unit itself.

2 Attach the front panel.

Press the right end of the front panel until it clicks into place.

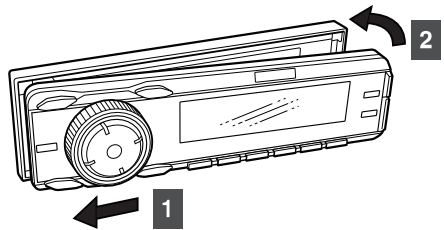

CAUTION

- If you drop the detachable panel or subject it to impact, it may be damaged or malfunction.
- Do not attempt to detach or attach the detachable panel while driving since this could cause an accident.
- Store the detachable panel in a location free from humidity, dust, and water.
- Do not leave the detachable panel in locations that are likely to become hot, like the dashboard and surroundings.

How to operate the CD/MP3/WMA player

About compact discs

- The signal recorded on a compact disc is read by a laser beam, so nothing touches the disc surface. A scratch on the recorded surface or a badly warped disc may cause deteriorated sound quality or intermittent playback. Observe the following precautions to ensure high quality sound performance:

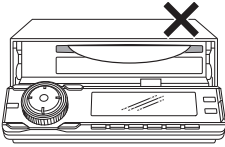

- Do not leave an ejected disc in the disc slot for very long; the disc may warp. Discs should be stored in their cases and kept away from high temperature and humidity.

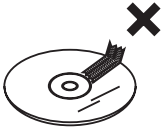

- Do not adhere a piece of paper or tape. Do not write on or scratch either side of a disc.



- Discs spin at a high speed inside the main unit. Keep cracked or warped discs out of the player to avoid damaging the main unit.



- Avoid touching the recorded surface when handling a disc; handle discs by their edges.

About brand new CDs

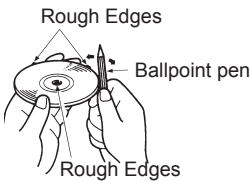

- You may notice that some brand new discs are rough around the center hole or outside edge. Remove the rough edges with the side of a ballpoint pen, etc. Rough edges may prevent proper loading in the main unit. Flakes from the rough edges may also stick to the recorded surface and interfere with playback.

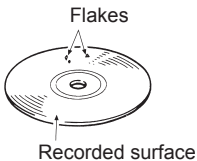

About CD accessories

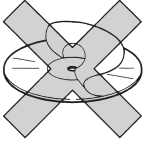

- Do not use accessories (stabilizers, protective seals, laser lens cleaners, etc.) sold for “improving sound performance” or “protecting CDs.” The changes in CD thickness or outside dimensions made by these accessories may cause problems in the player.

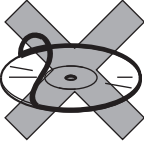

- Please be sure NOT to attach any ring-shape protector (or other accessory) to your discs. Those protectors are commercially available and said to protect disc and to improve sound quality (and antivibration effect), but they can do more harm than good in regular uses. The most common problems are disc insertion, disc ejections, and won't play problems due to the protector ring that came off in the disc mechanism.

IV

About borrowed CDs

- Do not use a CD with glue or remnants of adhesive tape or labels. They may cause the CD to get stuck inside or damage the main unit.

How to remove CDs

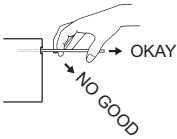

- When removing the ejected disc, pull it straight out along the slot. Removing the disc in a downward or upward angle may scratch the recorded surface of the disc.

About irregularly-shaped CDs

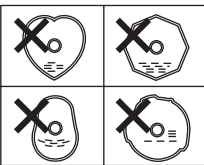

- Specially-shaped CDs, such as heart-shaped or octagonal CDs, cannot be played. Do not attempt to play them, even with an adapter connected, as they may damage the player.

About cleaning a CD



- Use a commercially available compact disc cleaner to clean a CD, wiping gently from the center to the edge.



- Do not use benzine, thinner, LP record spray or other cleaners on CDs. They may damage a CD's finish.

About MP3/WMA



ATTENTION

The making of MP3/WMA files by recording from sources such as broadcasts, records, recordings, videos and live performances without permission from the copyright holder for uses other than personal enjoyment is prohibited.

What is MP3/WMA?

MP3 (MPEG Audio Layer III) is a standard format for audio compression technology. By using MP3, a file can be compressed to one-tenth the size of the original.

WMA (Windows Media™ Audio) is format for audio compression technology. WMA files can be compressed to a size smaller than MP3 files.

This main unit has limitations on MP3/WMA file standards and recorded media and formats that can be used.

Playable MP3 file standards

- Supported standards:
MPEG-1 Audio Layer III
- Supported sampling frequencies:
44.1, 48 (kHz)
- Supported bit rate:
64, 80, 96, 112, 128, 160, 192, 224, 256, 288, 320 (kbps)
 - * Supports VBR. (64~320 kbps)
 - * Does not support free format.
- Supported channel modes:
monaural, stereo, joint, dual

Playable WMA file standards

- Supported standard:
WMA Ver.7
WMA Ver.8
WMA Ver.9
- Supported sampling frequencies:
32, 44.1, 48 (kHz)
- Supported bit rate:
48, 64, 80, 96, 128, 160, 192, 256, 320 (kbps)
 - * Supports VBR (48~192 kbps).
 - * Does not support lossless compression.
 - * Does not support WMA files recorded at a frequency of 48 kHz with a bit rate of 96 kbps.

ID3/WMA tag

MP3/WMA files have an “ID3 / WMA Tag” that allows input of information so that data such as song title and artist can be saved.

This main unit supports ID3v. 1.0, 1.1 and WMA tags.

Media

Media capable of playing MP3/WMA includes CD-R and CD-RW discs. Compared to CD-ROM media commonly used for music discs, CD-R and CD-RW discs are fragile in high temperature/high humidity environments and one section of the CD-R and CD-RW may become incapable of playback. Fingerprints or scratches on the disc may prevent playback or cause skipping during playback. Sections of a CD-R and CD-RW may deteriorate if left inside a vehicle for long periods of time. It is also recommended that CD-R and CD-RW discs be kept in a light-blocking case because the discs are vulnerable to ultra-violet light.

IV

Format of discs

The format of discs to be used must be ISO9660 Level 1 or Level 2.

Control items for this standard are as follows:

- Maximum layers in directory:
8 layers
- Maximum characters for folder names/file names:
32 (including “.” and 3 letter file extension)
- Allowable characters for folder names/file names:
A~Z, 0~9, _ (underscore)
- Number of files possible on a single disc:
999

[Configuration example for CD supporting MP3/WMA]

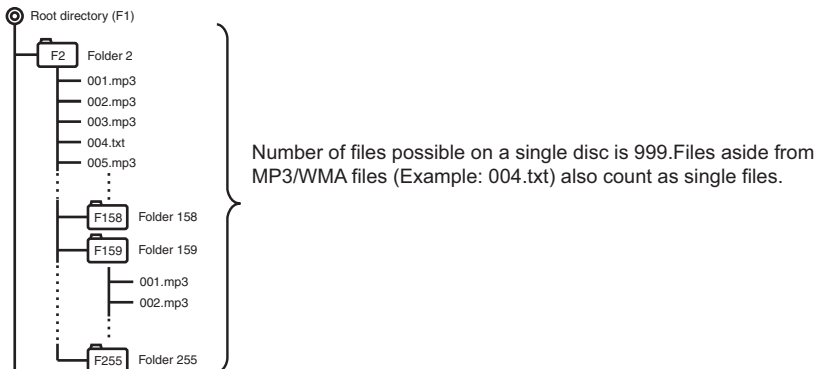

- Total number of folders possible on a single disc:
255
- Maximum folders this main unit can recognize:
256*

*: A root directory is counted as one folder.

File names

Only files with the MP3/WMA file extension “.mp3”, “.wma” can be recognized as MP3/WMA and played. Be sure to save MP3 files with the “.mp3” file extension. Be sure to WMA files with the “.wma” file extension. The “MP” letters of the file extension will be recognized whether entered as uppercase letters or lowercase letters.



CAUTION

If the “.mp3”, “.wma” file extension is attached to a file other than an MP3/WMA file, that file will be mistakenly recognized by the main unit as an MP3/WMA file and played, resulting in loud noise output that can damage the speakers. Be sure to avoid attaching the “.mp3”, “.wma” file extension to files that are not MP3/WMA files.

Multi-sessions

Multi-sessions are supported, and the playing of CD-R and CD-RW discs with MP3/WMA files added is possible. However, if files have been written onto a disc using “Track at once”, close the session or perform the finalization process. Standardize the format so that it does not change with each session.

Playing MP3/WMA

When a disc with recorded MP3/WMA files is inserted, the main unit first checks all the files on the disc. No sound is output while the main unit is checking the files on the disc. It is recommended that the disc be recorded without files other than MP3/WMA files and without unnecessary folders in order to speed up the checking of disc files by the main unit.

MP3/WMA playing time display

It is possible that playing time will not be correct, depending on the writing condition of the MP3/WMA file.

* It is possible that playing time will not be correct when VBR Fast Up/Down is operated.

Display order of MP3/WMA file/folder names

Names of MP3/WMA folders and files within the same level are displayed in the following order.

- 1.MP3/WMA folders displayed first, by ascending order of numbers, letters.
- 2.Files displayed next, by ascending order of numbers, letters.

Listening to CD

1 Press the [▲ (OPEN/EJECT)] button.

The front panel opens.

If a disc has already been loaded, the disc will be ejected.

2 Insert a CD into the disc slot, label side up.

The front panel automatically closes and the CD will immediately start playing.



ATTENTION

- Playback may be intermittent when there is a scratch on a CD or when the recorded side is dirty.
- If a CD has already been loaded, press the [SOURCE/PWR] button for less than one second to switch to the CD mode. (For details, refer to "Switching Audio Modes" on page 18.)



CAUTION

Do not press the [▲ (OPEN/EJECT)] button while a CD is being loaded. This could cause injuries or damage to the front panel.

NOTE

- When music data recorded in the normal way (CD-DA) is present on the same disc with MP3/WMA music files, the normally recorded music data will be played. To listen to the MP3/WMA music files, press [MODE] button for more than one second.
- MP3/WMA files which are not supported cannot be played. In this case, [NO SUPPORT] is displayed.
- The optional CD changer cannot be used to play MP3/WMA files.

TRACK (FILE) UP/DOWN

CD, MP3/WMA

1 Briefly press the [SELECT] (Right/Left) button.

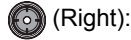

(Right):

Advances to the next track (file).



(Left):

Returns to the beginning of the track being played.

CD (Rotary mode)

1 Turn the [VOL] button.



(Right):

Advances to the next track.



(Left):

Returns to the beginning of the track being played.

MP3/WMA (Rotary mode)

1 Press the [MODE] button for less than one second to display the file list.

2 Turn the [VOL] button to select the file.



(Right):

Advances to the next track.



(Left):

Previews previous tracks.

3 Press the [ENTER] button.



ATTENTION

For details on how to operate the rotary mode function, refer to page 19.

FOLDER UP/DOWN

MP3/WMA

1 Press the [SELECT] (Up/Down) button.



(Up):

Selects the next folder.



(Down):

Selects the previous folder.

Returning to the root directory of the CD (MP3/WMA file)

In the root directory, when a file cannot be played, the system will return to the first file that can be played. (In the configuration example, the file is returning to 001.mp3. Refer to page 25.)

CD, MP3/WMA

1 Press the [RTN/BAND] button.



The main unit will move to the root directory and the first music track (file) will be played.



ATTENTION

When there is no file to be played in the root directory, the file in the first folder is played.

FAST FORWARD/REWIND

CD, MP3/WMA

1 Press and hold the [SELECT] (Right/Left) button.



(Right):

Fast forwards.



(Left):

Rewinds.

SCAN/REPEAT/RANDOM

CD

1 Press the [4 SCAN] button, the [5 RPT] button or the [6 RAND] button.

SCAN

4 :

The main unit will play the first 10 seconds of each track. To cancel, press button again.

RPT

5 :

Repeating the same track. To cancel, press button again.

RAND

6 :

Change the order of the tracks, and play them in random order. Press the button again to cancel this operation.

MP3/WMA**1**

Press the [4 SCAN] button, the [5 RPT] button or the [6 RAND] button.

SCAN

4 :

The main unit will play the first 10 seconds of each file located in the same layer as the folder currently being played. Press the button again to cancel this operation.

RPT

5 :

Repeating the same file. To cancel, press button again.

RAND

6 :

The main unit will randomly play all files located in the same layer as the folder currently being played. Press the button again to cancel this operation.

**ATTENTION**

- During random playback, press the [5 RPT] button to repeat the track (file) being played. Press the [5 RPT] button again to cancel repeat play (and return to random play).
- Occasionally the same track will play two or more times. This is a normal operation and is not a sign of a problem.
- [SCAN], [REPEAT], or [RANDOM] will appear on the display when these functions are active.

**FOLDER SCAN/REPEAT/
RANDOM****MP3/WMA****1**

Press the [4 SCAN] button, the [5 RPT] button or the [6 RAND] button for more than 1 second.

SCAN

4 :

The first 10 seconds of the first song in each folder is played. To cancel, press button again.

RPT

5 :

The tracks in the same layer as the folder being played are played repeatedly. Press the button again to cancel this operation.

RAND

6 :

The files in all folders are played randomly. To cancel, press button again.

DISPLAYING TITLE**(TEXT supported CD's)****1**

Press the [SCREEN/TEXT] button for more than one second.

TEXT

SCREEN :

CD text will be scrolled on the display.

MP3/WMA

- 1 Press the [SCREEN/TEXT] button for more than one second.



Each time the button is pressed, the text will be displayed in the following order.

Folder Name/File Name* → Tag

*: A maximum of 14 characters can be displayed in the display area. The remaining characters can be displayed by scrolling. The folder name is displayed first. The file name can then be displayed by scrolling. After the file name has been displayed, the display will be fixed.

ATTENTION

- CD text cannot be displayed using CD changers (sold separately).
- If the CD came with a logo shown below, it is recorded with a disc title and track titles. These information will be displayed during playback.



- CD text, Folder name/file name or tag recorded with characters other than alphanumeric and symbols cannot be displayed.

Ejecting the disc

- 1 Press the [▲ (OPEN/EJECT)] button.

The front panel opens and the disc is ejected.

ATTENTION

If a loaded CD is not ejected, press the [▲ (OPEN/EJECT)] button for more than five seconds with the front panel open to eject the disc.

- 2 Remove the disc and press the [▲ (OPEN/EJECT)] button.

The front panel closes.

CAUTION

- Do not drive with the front panel open. The panel may cause unexpected personal injury during a panic stop, or the like.
- Do not attempt to close the front panel by hand. Doing so may damage the panel.

MEMO

How to operate the USB music file player

About playable USB memory standards

- Supported File System:
FAT 12/16/32
- Playable Audio Format:
MP3/WMA
- Max.Current:
500mA
- Compatibility:
USB1.1/2.0
- Correspondence:
USB mass storage class

Playable MP3 file standards

- Supported standards:
MPEG-1
MPEG-2
MPEG-2.5
Audio Layer III
- Supported sampling frequencies:
MPEG-1:32, 44.1 (kHz)
MPEG-2:16, 22.05, 24 (kHz)
MPEG-2.5:8, 11.025, 12 (kHz)
- Supported bit rate:
MPEG-1: 32, 40, 48, 56, 64, 80, 96, 112, 128, 160, 192, 224, 256, 288, 320 (kbps)
MPEG-2: 8, 16, 24, 32, 40, 48, 56, 64, 80, 96, 112, 128, 160 (kbps)
MPEG-2.5: 8, 16, 24, 32, 40, 48, 56, 64, 80, 96, 112, 128, 160 (kbps)
* Supports VBR. (8~320 kbps)
* Does not support free format.
- Supported channel modes:
monaural, stereo, joint, dual

Playable WMA file standards

- Supported standards:
WMA Ver. 7
WMA Ver. 8
WMA Ver. 9
- Supported sampling frequencies:
8, 11.025, 12, 22.05, 32, 44.1 (kHz)
- Supported bit rate:
8, 16, 24, 32, 40, 48, 64, 80, 96, 128, 160, 192 (kbps)
* Supports VBR (40~95 kbps)
* Does not play DRM.

- Supported channel modes:
monaural, stereo

Format of USB memory

The USB memory format must be ISO9660 Level 1 or Level 2. Standards are as follows:

- Maximum directory layers:
8 layers
- Maximum characters for folder names/file names:
128 (including "." and 3 letter file extension)
- Allowable characters for folder names/file names:
A~Z, 0~9, _ (underscore)
- Number of files possible on a single USB memory:
3000

[Configuration example for USB memory supporting MP3/WMA]

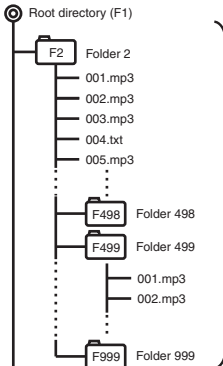

Number of files possible on a single USB memory is 3000. Files aside from MP3/WMA files (Example: 004.txt) also count as single memories.

- Total number of folders possible on a single USB memory:
999
- Maximum folders this main unit can recognize:
1000*

*: A root directory is counted as one folder.



How to operate the USB music file player

When a USB memory or a digital audio player with a USB terminal is connected to a USB connector, music files can be played from the USB memory.

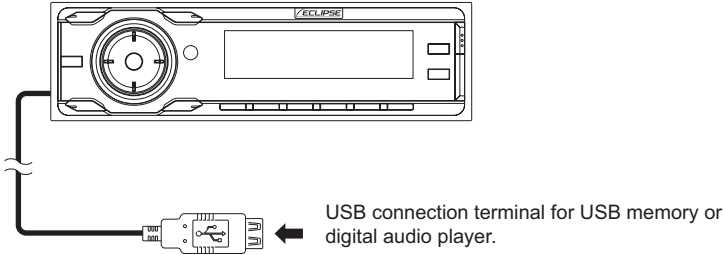

Listening to music files in USB memory

1 Connect the USB memory to the USB connector.

2 Switch to the USB mode.

For details, refer to "Switching Audio Modes" on page 18.

3 Operate the USB music file player.

The procedure for playing music is the same as that are used to play CDs. Refer to "How to operate the CD/MP3/WMA player" (page 27 - 29).



ATTENTION

If the USB mode is changed to another mode and then returned to the USB mode, the player will return to the previous file played.



CAUTION

- Do not disconnect the USB memory or turn the ignition key to ACC OFF position while accessing the USB memory. Doing so may corrupt the data.
- Depending on the type connected, the USB memory may not work in some cases.
- The USB memory does not support multi-partition. or USB hub.
- It is highly recommended to back up your data in case of accidental deletion.
- Install and use the USB device in a place that provides safe operation of the vehicle.
- The music files under the copyright protection cannot be played.
- When connecting a digital audio player to the USB connector, additional USB adaptors may be required.

Disconnecting USB memory

1 Disconnect the USB memory parallel to the USB connector.



ATTENTION

Do not remove the USB memory while playing, reading or writing data.



CAUTION

Do not apply excessive force when removing the USB memory. Doing so may damage the USB connector and/or the USB memory.

The Bluetooth audio function

About the Bluetooth audio function

The use of Bluetooth wireless communication technology enables a Bluetooth-compatible portable audio player (hereafter called "a portable device") to be used as a source for the main unit.

Once the portable device is connected to the main unit, it is possible to listen to music without directly operating the portable device.

Because the connection between the portable device and the main unit is wireless, cable connection is not needed.

- Before using a Bluetooth-compatible portable device (including cell phones) with the main unit, be sure to complete the "Setting the Bluetooth audio functions". (See pages 38 and 39 for instructions)
- When the portable device has been connected to the main unit, the Bluetooth connection indicators will be displayed.

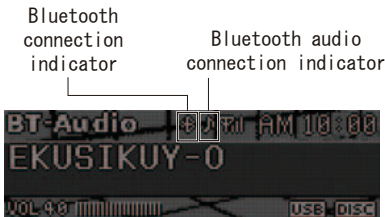

- Noise may be experienced when using the Bluetooth cell phone and Bluetooth audio.
- Depending on the version of Bluetooth, some cell phones may not be able to communicate with the main unit.
- Depending on the surrounding environment, the connection may become unstable, and the Bluetooth audio function may not be able to be operated from the main unit.

ATTENTION

- If the portable device is used with other wireless devices, it may have a negative effect on the communication capabilities of both.
- The Bluetooth communication connection may cause the batteries in the portable device to lose their charge quickly.

About the Bluetooth specifications

The Bluetooth-compatible portable device to be connected to the main unit must be compatible with the following specifications. (However, depending on the models of the portable device, some of the functions may be limited.)

Supported Bluetooth specifications

Bluetooth Specification Ver.2.0

Supported profile

- A2DP (Advanced Audio Distribution Profile) Version 1.0:
Profile for transmission of high quality sound
- AVRCP (Audio/Video Remote Control Profile) Version 1.0:
Profile for control of AV equipment by remote-control

What is Bluetooth?

Bluetooth is a form of short-range wireless communication technology, used to connect cell phones and personal computers.

This technology enables hands-free calling and data transmission between Bluetooth-compatible devices.



Bluetooth is a registered trademark of Bluetooth SIG, Inc.

WARNING

For safety reasons, the driver must not operate the portable device while driving. Stop the vehicle in a safe location before operating the device.

CAUTION

- Do not leave the portable device inside a vehicle. (The temperature inside a vehicle may increase dramatically when it is exposed to extreme heat from the sun.)
- Do not use the portable device in a location close to the main unit. If they are too close together, the sound quality and the connection may be adversely effected.

Listening to music

1 Switch to the Bluetooth audio mode.

For details, refer to "Switching Audio Modes" on page 18.

2 Press the [SELECT] (Up) button.

The connected Bluetooth-compatible portable device starts to play music.

ATTENTION

- If the portable device is not connected to the main unit, its play function is disabled.
- If the portable device does not start playing, even after you have pressed the [SELECT] (Up) button, press the Play button on the portable device.

VI

Stopping the music

1 Switch to another audio mode.

For details, refer to "Switching Audio Modes" on page 18.

ATTENTION

The portable device may continue to play music even if it is switched to another audio mode.

Pausing the music

1 Press button [1].

The music being played is paused.

ATTENTION

Press the [SELECT] (Up) button or button [1] to start playing the music.

Selecting the music you want to listen to

1 Press the [SELECT] (Right/Left) button.

Right:

Advances to the next track.

Left:

Returns to the beginning of the track being played.



ATTENTION

Press the [SELECT] (Left) button repeatedly to return to previous tracks.

Fast forward/rewind

1 Press and hold the [SELECT] (Right/Left) button.

Right:

Fast forwards.

Left:

Rewinds.



ATTENTION

The fast forwarding or rewinding will continue until the [SELECT] (Right/Left) button is released.

Bluetooth audio setup

A variety of functions available when using the portable device can be set from the BT Audio Set mode.

- BT Audio setting:
Bluetooth audio mode on and off.
- Connection setting:
Main unit and portable device connectivity.
- Disconnection setting:
Disconnects the main unit and the portable device.

- Device INFO display:
Displays device information for the main unit.

Displaying the BT Audio Set selection mode

1 Press the [PHONE/MENU] button for more than one second.

The MENU selection mode is displayed.

2 Press the [SELECT] (Up/Down) button to select FUNC.

3 Press the [ENTER] button.

4 Press the [SELECT] (Up/Down) button to select BT AUDIO Set.

5 Press the [ENTER] button.

The BT Audio Set selection mode is activated.

Switching the Bluetooth audio mode on and off

The Bluetooth audio function can be selected while in the audio mode.

1 Press the [SELECT] (Up/Down) button while in the BT Audio Set selection mode to select ON or OFF.

2 Press the [ENTER] button.

3 Press the [SELECT] (Up/Down) button to select ON or OFF.

ON:

Enables BT-Audio

OFF:

Disables BT-Audio

4 Press the [RTN/BAND] button.

The portable device is set as a Bluetooth audio source.

**ATTENTION**

- The Bluetooth audio (BT-Audio) function can only be selected in the audio mode when the BT Audio Set selection mode is set to ON.
- The default setting for the Bluetooth audio mode is OFF (BT-Audio selection is disabled).

Connecting the main unit and the portable device

1 Press the [SELECT] (Up/Down) button while in the BT-Audio Set selection mode to select Connect.**2 Press the [ENTER] button.**

The "Waiting" message appears on the display.

**ATTENTION**

Press the [RTN/BAND] button to change the portable device to be connected. The BT-Audio Set selection mode is activated again.

3 Input the passcode using the portable device.



The default setting value of the passcode is 1234.

**ATTENTION**

- For details on how to operate the portable device, read its instruction manual.
 - Be sure to perform the connection of the portable device only while the "Waiting" message is on the display.
-

4 When the connection has been completed, the "COMPLETED" message appears on the display.

The portable device is now connected to the main unit.

( and ) appear on the display.)

If the connection has not been successfully completed, the "FAILED" message appears on the display.

**ATTENTION**

- If the portable device is still connected, disconnect it.
- If the connection has not been successfully completed, and the "FAILED" message appears on the display, connect the portable device again, following the procedure from the BT Audio Set selection mode in Step 1.
- The passcode is a password used when connecting the portable device to the main unit.
- When the audio of the cell phone is connected, hands-free can be connected at the same time for some devices. If you want to be able to use the hands-free function, perform the hands-free connection procedure again.

Disconnecting the main unit and the portable device

1 Press the [SELECT] (Up/Down) button while in the BT Audio Set selection mode to select Disconnect.**2 Press the [ENTER] button.**

The "Disconnect ?" message appears on the display.

3 Press the [ENTER] button.



ATTENTION



If you do not want to cancel the connection, press the [RTN/BAND] button. The BT Audio Set selection mode is activated again.

3 Press the [RTN/BAND] button.

The BT Audio Set selection mode is activated again.

4 When the disconnection has been completed, the "COMPLETED" message appears on the display.

The main unit is now disconnected from the portable device.

( and  disappear from the display.)

However,  will not disappear while Bluetooth hands-free is connected.)

Displaying device information for the main unit

The name of the device (main unit), the passcode and the BD ADD (device address) can be displayed.

1 Press the [SELECT] (Up/Down) button while in the BT Audio Set selection mode to select Device INFO.

2 Press the [ENTER] button.

The name of the device and the passcode are displayed.



ATTENTION

Each time the [SCREEN/TEXT] button is pressed, the display changes in the following way.

Device name / passcode ↔ Device name / BD ADD (device address)

MEMO

How to operate the tuner



ATTENTION

- If stations have been stored in the memory, pressing a button from [1] to [6] will enable you to select a station. (Refer to "Manually storing stations into memory" on page 43.)

Listening to the tuner

1 Switch to tuner mode.

For details, refer to "Switching Audio Modes" on page 18.

Tuning to a station

There are both automatic and manual methods (one of each) for storing stations in memory. The main unit can store up to 24 stations in memory. There are 6 stations for AM and 18 stations for FM (6 each for FM1, FM2 and FM3) (initial settings).

1 Press the [RTN/BAND] button briefly (for less than one second) to switch to the desired FM or AM band.

Radio bands will switch from FM1 → FM2 → FM3 → AM in order each time the button is pressed.

2 Press the [SELECT] (Right/Left) button to tune to a station.

Right:
Tunes to higher frequencies.

Left:
Tunes to lower frequencies.

3

Press and hold the [SELECT] (Right/Left) button. The device starts to search for stations automatically.

Right:
Starts searching toward higher frequencies.

Left:
Starts searching toward lower frequencies.



ATTENTION

At times, it may be difficult to maintain optimum reception because the antenna attached to your vehicle is constantly in motion (relative to the broadcast antenna), encountering continuous variation in the strength of the radio signals received. Other factors affecting reception include interference from natural obstacles, buildings, etc.

When an optional HD Radio tuner unit is connected, digital broadcasts have reception priority. (U.S.A. only)

Operations during rotary mode

For the operation method in the Rotary mode, refer to page 19.

Automatically storing stations into memory. (The automatic preset mode: ASM)

- 1 Press the [SELECT] (Up) button for more than two seconds, until you hear a beep.

The automatic preset mode starts.

"ASM ON" will appear on the display, and stations are automatically entered in memory under buttons [1] to [6].

These buttons are called preset buttons.



ATTENTION

- Pressing the preset buttons ([1] to [6]) allows you to make one-touch station selections. The frequency of the selected station is indicated on.
- When a new station is set in memory, the station previously set in memory will be deleted.
- If there are fewer than six receivable stations, the stations set in the remaining buttons will be retained.



CAUTION

If the vehicle's battery is disconnected (for repairs to the vehicle or for removing the main unit), all stations in memory will be lost. In such a case, store stations in the memory again.

Manually storing stations into memory

Store a station to a preset button.

- 1 Press the [SELECT] (Right/Left) button to tune to the station that you want to store in memory.

- 2 Select any button, from [1] to [6], and press it for more than two seconds.

The selected station is now stored in a preset button.

Repeat the above procedure to store additional stations one at a time in buttons [1] to [6], and store them in memory.



CAUTION

If the vehicle's battery is disconnected (for repairs to the vehicle or for removing the main unit), all stations in memory will be lost. In such a case, store stations in memory again.

Preset station scan

This function enables reception of all the stations in the preset buttons for five seconds each.

- 1 Press the [SELECT] (Down) button for more than one second.

"P SCAN" will appear on the display, and stations stored under preset buttons [1] through [6] will be played for five seconds each.

- 2 When your desired station is displayed, press the [SELECT] (Down) button again.

The main unit will stay tuned to the desired station.

Changing the reception sensitivity for automatic scanning

The main unit lets you select the reception sensitivity to be used for automatic scanning of stations. The two sensitivity modes available for this main unit are AUTO mode and DX mode.

<p>AUTO Mode</p>	<p>During automatic scanning, the reception sensitivity switches automatically to one of two levels. Initially the reception sensitivity is set to the low level so that only stations with strong signals are received. If no stations could be received, the reception sensitivity is increased so that stations with weaker signals can also be received.</p>
<p>DX Mode</p>	<p>Because the reception sensitivity for automatic scanning is set to the high level from the start, even stations with weaker signals can be received. (Signal crossover may result in some stations being hard to hear.)</p>

ATTENTION

When an optional HD Radio tuner unit is connected, reception sensitivity is set to the AUTO Mode. The DX Mode is unavailable. (U.S.A. only)

1 Check that the main unit is in standby.

2 Press and hold button [1] and the [☎/MENU] button simultaneously for more than three seconds.

The mode switches between AUTO mode and DX mode each time the buttons are pressed.

Changing the radio band location

The location for the radio bands used between the North American region and the Asia/Australia/Latin region can be switched. The default setting is USA (North America).

ATTENTION

When an optional HD Radio tuner unit is connected, radio band location is set to USA. Other radio band locations are unavailable. (U.S.A. only)

1 Check that the main unit is in standby.

2 Press and hold button [3] and the [☎/MENU] button simultaneously for more than three seconds.

The radio band switches in the order shown below each time the buttons are pressed.

USA → ASIA → AUS → LATIN →
USA ...

When the power is turned on, stations will be searched for automatically, and stored in buttons [1] to [6].

MEMO

How to use the remote control

Precautions in use of the remote control

- Be careful when handling the control, especially because it is small and light. Dropping or striking it hard may damage it, wear out the battery or cause a malfunction.
- Keep the remote control free of moisture, dust and water. Do not subject it to shock.
- Do not place the remote control unit in places where it could be exposed to high temperatures, such as on the dashboard or near a heater vent. Allowing the remote control unit to overheat may warp its case or cause other problems.
- Do not operate the remote control unit while driving because doing so could cause an accident.
- When using the remote control, point it toward the remote control light receptor.
- The light receptor may not operate correctly if it is exposed to bright light such as direct sunlight.
- Remove the batteries from the remote control unit whenever it is not to be used for a long time.

Cleaning the remote control





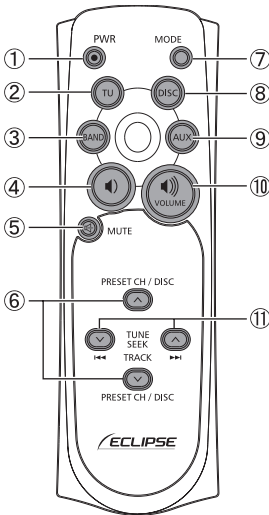



- Use a dry cloth to keep the remote control clean. If the remote control unit gets extremely dirty, clean it with a cloth lightly moistened with diluted liquid detergent.
- In no event should alcohol, benzine or thinner be used. These substances will damage the case or finish.

Remote control



(RMC-105)

No.	Button	Name/Working
①		[PWR] button Turns main unit power ON/OFF.
②		[TU] button Switches to the tuner mode.
③		[BAND] button Switches radio band.
④		[◀] button Decreases audio volume (including hands free mode).
⑤		[MUTE] button Activates and deactivates mute.

No.	Button	Name/Working
⑥		[√ PRESET CH ^] buttons [√ DISC ^] buttons Selects radio preset channels and performs disc mode functions.
		
⑦		[MODE] button Switches audio source mode.
⑧		[DISC] button Switches to DISC mode (CD, CD changer, USB or iPod).
⑨		[AUX] button Switches to AUX mode.
⑩		[] button Increases audio volume (including hands free mode)
⑪		[√ TUNE-SEEK ^] buttons [►► TRACK ◄◄] buttons Selects radio stations and CD tracks.
		

Replacing the battery

WARNING

To prevent accidents, store batteries out of the reach of children. If a child has swallowed one, consult a doctor immediately.

Use two AAA size batteries.

- 1** While pressing the back cover of the remote control unit, slide it in the direction indicated by the arrow to remove it.



- 2** Insert the two batteries as indicated into the battery compartment.

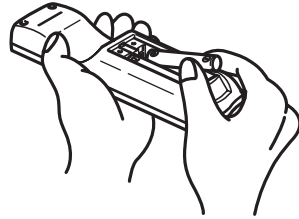

- 3** Slide the back cover in the direction indicated by the arrow to close the battery case.

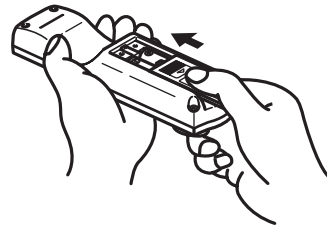

The Bluetooth hands-free function

About the Bluetooth hands-free function

The use of Bluetooth wireless communication technology enables a Bluetooth-compatible cell phone to be able to be used with the main unit. Once the cell phone is connected to the main unit, it is possible to make calls without directly operating the cell phone. Because the connection between the cell phone and the main unit is wireless, communication is possible even when the cell phone is in your bag or pocket. Cable connection and wiring is not necessary.

- The main unit can be used with Bluetooth-compatible cell phones.
- Before using a Bluetooth-compatible cell phone with the main unit, please be sure to perform the Bluetooth registration and connection setting procedures. (For details, refer to "Registering a cell phone" on page 53 and "Connecting a registered cell phone" on page 54.)
- When the cell phone has been connected to the main unit, the Bluetooth connection indicator and the radio wave status/phone connection status indicator appear on the displayed as shown below.

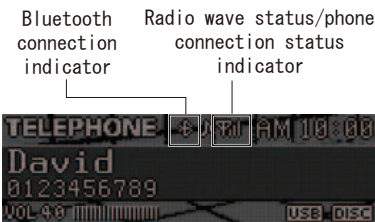

- Once the cell phone has been connected to the main unit, it will remain connected until the connection is cancelled.
- Depending on the version of Bluetooth, some cell phones may not be able to communicate with the main unit.

- Depending on the surrounding environment, the connection may become unstable, and the Bluetooth hands-free function may not be able to be operated from the main unit. In such cases, confirm that the connection status is good by referring to the radio wave status indicator on the display, and then repeat the procedure.
- Some cell phones may not be compatible with the main unit.

ATTENTION

Using Bluetooth may cause batteries in connected devices to drain more quickly.

About the Bluetooth specifications

The Bluetooth-compatible cell phone to be connected to the main unit must be compatible with the following specifications. (However, depending on the model of the cell phone, some of the functions may be limited.)

Supported Bluetooth specifications

Bluetooth Specification Ver.2.0

Supported profile

- HFP (Hands Free Profile) Version 1.5: Profile for connection to Bluetooth-compatible hands-free devices
- OPP (Object Push Profile) Version 1.1: Profile for transmission of address book and schedule

What is Bluetooth?

Bluetooth is a form of short-range wireless communication technology used to connect cell phones and personal computers.

This technology enables hands-free calling and data transmission between Bluetooth-compatible devices.



ATTENTION

Please check with your cell phone manual for Bluetooth operation.



Bluetooth is a registered trademark of Bluetooth SIG, Inc.

WARNING

- For safety reasons, the driver must not operate the cell phone while driving.
- State and local ordinances must be strictly followed when using cell phones.

Selecting the Bluetooth hands-free mode

1 Press the [MENU] button

The Bluetooth hands-free mode is activated.



ATTENTION

- The Bluetooth hands-free mode can be activated from any audio mode.
- At any time the [RTN/BAND] button can be pressed to return to the previous step.

Making a call

This function enables you to dial phone numbers from the main unit, or to make calls using the stored phone numbers (phonebook) and incoming/outgoing call history.

Making a call by dialing a phone number

Calls can be made by dialing phone numbers from the main unit.

Before dialing a phone number directly from the main unit, set Dial Setting of the Phone Setting selection mode to ON. (For details, refer to "Enabling phone numbers to be input directly" on page 57.)

- 1 Press the [MENU] button
- 2 Press the [MODE] button repeatedly until the "Dial Input" is displayed.
- 3 Press the [SELECT] (Up/Down) button to input numbers between 0 and 9.
 - Up:
Increases the number.
 - Down:
Decreases the number.
- 4 Press the [SELECT] (Right/Left) button to move the cursor.
 - Right:
The cursor moves to the right.
 - Left:
The cursor moves to the left.
- 5 Repeat the Steps 3 and 4 to input the phone number.



ATTENTION

A maximum of 28 digits can be input per phone number.

If you input an incorrect number, move the cursor to that number, and input the correct number by following Step 3.

6 Press the [ENTER] button when you have input the phone number.

The input number confirmation screen appears on the display.

7 Press the [ENTER] button.

The input phone number is dialed.

Making a call using preset dial

Calls can be made using the phone numbers stored to the preset dial buttons.

1 Press the [☎/MENU] button

2 Press a preset dial button between [1] and [6].

The phone number and name stored in the selected preset dial button appear on the display, and the number is dialed (two beeps will be heard if no phone number is stored).

Making a call using the incoming/outgoing call history

Calls can be made using phone numbers stored in the incoming/outgoing call history of the main unit.

1 Press the [☎/MENU] button

2

Press the [MODE] button repeatedly until the "Incoming Calls" is displayed. (Incoming call history) message appears on the display.

The incoming call history appears on the display. To make a call from the outgoing call history, press the [MODE] button repeatedly until the "Outgoing Calls" is displayed.

3

While in the call history selection mode, turn the [VOL] button to select the number you want to call.

4

Press the [ENTER] button.

The phone number and name stored in the phonebook appear on the display to confirm the number to be dialed.

5

Press the [ENTER] button.

The phone number on the display is dialed.



ATTENTION

- A maximum of 10 outgoing and 10 incoming call records can be stored in one cell phone. If an attempt is made to store more than 10 call records, the oldest call record will be deleted.
- If the battery of the vehicle is disconnected, the call history stored in the main unit will be deleted.

Making a call using the phonebook

Calls can be made using the phone numbers stored in the phonebook of the main unit.

- 1** Press the [/MENU] button
- 2** Press the [MODE] button repeatedly until the "Phonebook" is displayed.
- 3** While in the phonebook selection mode, turn the [VOL] button to select the number you want to call.
- 4** Press the [ENTER] button.

The phone number and name stored in the phonebook appear on the display to confirm the number to be dialed.

- 5** Press the [ENTER] button.

The phone number on the display is dialed.

Making a call from the cell phone

Calls can be made using a cell phone which is connected to the main unit.

- 1** Make a call using the cell phone.

ATTENTION

- If the phone number dialed from the cell phone has been stored in the phonebook of the main unit, the name and phone number will appear on the display.
 - Depending on the cell phone, you may have to use the cell phone to talk even when the call has been made from the main unit.
-

Receiving a call

Calls can be received while in any source mode. There is also an automatic answering function to answer automatically. For details on answering calls automatically, refer to "Setting Auto Answer" on page 56.

- 1** When the phone rings, press the [ENTER] button or the [SELECT] button.

A phone connection is made, and you can start talking.

Hanging up (refusing a call)

Calls can be terminated or refused.

- 1** Press the [/MENU] button

The phone call is terminated.

ATTENTION

Calls which have been refused are also stored in the memory.

Adjusting the volume

The volume of the ring tone and the voice volume can be adjusted.

For safety reasons, do not adjust the volume of the ring tone or the voice volume while driving.

Adjusting the ring tone volume

Adjusting the volume of the ring tone while the phone is ringing.

- 1** Turn the [VOL] button to adjust the volume.

To increase the ring tone volume:

Turn the [VOL] button to the right.

To decrease the ring tone volume:

Turn the [VOL] button to the left.

Adjusting the voice volume

Adjust the voice volume while the call is in progress.

1 Turn the [VOL] button to adjust the volume.

To increase the volume:
Turn the [VOL] button to the right.

To decrease the volume:
Turn the [VOL] button to the left.

Storing phone numbers in preset dial

It may be convenient for you to store phone numbers that you call regularly in preset dial. A maximum of 6 phone numbers from the call history or the phonebook can be stored in one cell phone's preset dial.

1 Displaying the call history or the phonebook.

(See page 50 to display call history). Select the phone number using the rotary dial. Press enter to confirm the phone number to be stored.

2 Press and hold the preset dial button between [1] and [6] that you want to store a number in, until you hear a beep.

The displayed phone number from the call history or the phonebook is stored in preset dial.

Setting the Bluetooth hands-free function

A variety of settings that can be used when operating the cell phone can be made from the Bluetooth hands-free Phone Setting mode.

- Registration setting:
To register a cell phone.
- Select Phone setting:
To select a registered cell phone, and connect, disconnect, or delete it.

- Phone Book setting:
To store data from the phonebook of the cell phone in the phonebook of the main unit.
- Auto Answer setting:
To set the cell phone to Auto Answer.
- Ring tone setting:
To set the ring tone.
- Auto Connect setting:
To connect a registered cell phone.
- Device INFO display setting:
To display device information for the main unit.
- Dial setting:
To enable a phone number to be input using the main unit.
- Delete setting:
To delete data from the incoming/outgoing call history, preset dial, or phonebook of the main unit.
- Change Code setting:
To change the passcode.

Displaying the Phone Setting selection mode

1 Press the [☎/MENU] button for more than one second.

The MENU selection mode is displayed.

2 Press the [SELECT] (Up/Down) button to select FUNC.

3 Press the [ENTER] button.

4 Press the [SELECT] (Up/Down) button to select Phone Setting.

5 Press the [ENTER] button.

Phone Setting selection mode is activated.

Registering a cell phone

Cell phones can be registered in the main unit. There are two methods that can be used to register a cell phone in the main unit.

The cell phone itself can be used or search for cell phones using the main unit. A maximum of five cell phones can be registered in the main unit. Priority of connection will always be in sequential order from 1 to 5. As cell phones are added and deleted, the order will always go by the numbered sequence.

Registering using a cell phone

If a cell phone is currently connected, it must be disconnected prior to registration of additional cell phones.

1 Press the [SELECT] (Up/Down) to select Registration within the Phone Setting mode.

2 Press the [ENTER] button.

ATTENTION

NO ENTRY will be displayed if available. If not, a double beep will be heard if the phone registration memory is not available or full.

3 Press the [SELECT] (Up/Down) button to select Allow Connect.

4 Press the [ENTER] button.

The "Waiting" message appears on the display.

5 Use the cell phone to input the passcode.

The default passcode is 1234.

ATTENTION

- For details on how to operate the cell phone, read its instruction manual.

- Be sure to perform the registration of the cell phone only while the "Waiting" message is on the display.

6 When the registration has been completed, the "COMPLETED" message appears on the display.

The cell phone is now registered to the main unit

( and  appear on the display.)

If the registration has not been successfully completed, the "FAILED" message appears on the display. Repeat the registration procedure.

ATTENTION

- To register another cell phone to the main unit, press the [RTN/BAND] button twice after Step 6. Perform the registration procedure from the registered cell phone selection mode in Step 1.
- You cannot register a cell phone that has already been registered.
- The hands-free function and the audio function of the cell phone can be connected at the same time for some cell phones.

Searching for cell phones to be registered

1 Press the [SELECT] (Up/Down) to select Registration within the Phone Setting mode.

2 Press the [ENTER] button.

ATTENTION

NO ENTRY will be displayed if available. If not, a double beep will be heard if the phone registration memory is not available or full.

3 Press the [SELECT] (Up/Down) button to select Device Search.

4 Press the [ENTER] button.

"Searching" will be displayed.



ATTENTION

"FAILED" will be displayed if cell phone cannot be registered. Repeat Search procedure.

5 Press the [SELECT] (Up/Down) button to select the device name of the cell phone you want to register.



ATTENTION

Each time the [SCREEN/TEXT] button is pressed, the display changes in the following way, and you can register the cell phone using the device address (BD ADD) as well.
Device name ↔ Device address (BD ADD)
If the device name cannot be obtained during the search, "UNKNOWN" is displayed.

6 Press the [ENTER] button.

"Waiting" will be displayed.

7 Use the cell phone to input the passcode.

The default passcode is 1234.

8 When the registration has been completed, "COMPLETED" will be displayed.

The cell phone is now registered.

(and appear on the display.)

"FAILED" will be displayed if registration is not successful. Repeat Search procedure.

Delete a registered cell phone

1

Press the [SELECT] (Up/Down) button while in the Phone Setting selection mode to select Select Phone.

2

Press the [ENTER] button.

3

Press the [SELECT] (Up/Down) button to select cell phone to be deleted.

4

Press the [ENTER] button.

5

Press the [SELECT] (Up/Down) button to select Delete.

6

Press the [ENTER] button.

The "Delete ?" message appears on the display to confirm the cancellation.

7

Press the [ENTER] button.

8

"COMPLETED" will be displayed when deletion is successful.



ATTENTION

When a cell phone is deleted, all data associated will also be deleted (including history, preset dial, and phonebook) from the main unit.

Connecting a registered cell phone

1

Press the [SELECT] (Up/Down) button while in the Phone Setting selection mode to select Select Phone.

2

Press the [ENTER] button.

3 Press the [SELECT] (Up/Down) button to select the cell phone to be connected.

4 Press the [ENTER] button.



5 Press the [SELECT] (Up/Down) button to select Connect.

6 Press the [ENTER] button.

The "Waiting" message appears on the display.

7 "COMPLETED" will be displayed.

The cell phone is now connected to the main unit.

( and  appear on the display.)

"FAILED" will be displayed if registration is not successful. Repeat the connection procedure.

ATTENTION

Cell phones that have not been registered cannot be connected.

Disconnecting a cell phone

1 Press the [SELECT] (Up/Down) button while in the Phone Setting selection mode to select Select Phone.

2 Press the [ENTER] button.

3 Press the [SELECT] (Up/Down) button to select the cell phone to be disconnected.

4 Press the [ENTER] button.

5 Press the [SELECT] (Up/Down) button to select Disconnect.

6 Press the [ENTER] button.

The "Disconnect ?" message appears on the display to confirm the disconnection.

7 Press the [ENTER] button.

8 "COMPLETED" will be displayed when disconnection is successful.

Registering phone number in the phonebook

Phone numbers can be registered in the phonebook of the main unit by transferring the phonebook data from the cell phone.

A maximum of 500 phone numbers can be registered for each cell phone.

1 Press the [SELECT] (Up/Down) button while in the Phone Setting selection mode to select Phonebook.

2 Press the [ENTER] button.

The "DATA Receiving" message appears on the display.

3 Transmit phonebook data using your cell phone.

4 "COMPLETED" will be displayed when data transfer is successful.

"FAILED" will be displayed if data transfer is not successful. Repeat the transmit procedure.

 ATTENTION



Number of phone numbers that can be registered in the phonebook

- If there is no space remaining in the main unit for phonebook data, the "MEMORY FULL" message appears on the display when an attempt is made to transfer data from the cell phone.
- Some cell phones cannot transfer all of the phonebook data at once. In this case, transfer one data at a time.
- If the battery terminal of the vehicle is disconnected, the phonebook data registered in the main unit will be deleted.

Setting Auto Answer

When there is an incoming call, the phone can be set to answer it automatically five seconds after the phone starts ringing.

1 Press the [SELECT] (Up/Down) button while in the Phone Setting selection mode to select Auto Answer.

2 Press the [ENTER] button.

3 Press the [SELECT] (Up/Down) button to select ON or OFF.

ON:

Auto Answer is activated

OFF:

Auto Answer is disabled

 ATTENTION

The default setting for Auto Answer is OFF (Auto Answer is disabled).

Setting the ring tone

The ring tone can be set on or off for incoming calls. Ring tone is set ON by default.

1 Press the [SELECT] (Up/Down) button while in the Phone Setting selection mode to select Ring Tone.

2 Press the [ENTER] button.

3 Press the [SELECT] (Up/Down) button to select ON or OFF.

Setting Auto Answer for registered cell phones

Cell phones which have been registered to the main unit will be connected automatically, if the main unit and the Bluetooth are in an area where connection is possible.

Auto answer is set ON by default and may not be available for all cell phones.

1 Press the [SELECT] (Up/Down) button while in the Phone Setting selection mode to select Auto Connect.

2 Press the [ENTER] button.

3 Press the [SELECT] (Up/Down) button to select ON or OFF.

ON:

Connects automatically.

OFF:

Must be connected manually.

Displaying device information for the main unit

The name of the device (ECLIPSE BT), the passcode (default setting - 1234), and the BD ADD (device address) can be displayed.

1 Press the [SELECT] (Up/Down) button while in the Phone Setting selection mode to select Device INFO.

2 Press the [ENTER] button.

The name of the device and Passcode will be displayed. Pressing the [SCREEN/TEXT] button will toggle between Passcode and BD ADD.

Enabling phone numbers to be input directly

The default setting is OFF.

1 Press the [SELECT] (Up/Down) button while in the Phone Setting selection mode to select Dial Setting.

2 Press the [ENTER] button.

3 Press the [SELECT] (Up/Down) button to select ON or OFF.

Deleting data

Phonebook, Call History, Preset Dial, and All Data can be deleted.

ATTENTION

If there is no cell phone connected, the data in the phonebook cannot be deleted.

Deleting data from the phonebook

1 Press the [SELECT] (Up/Down) button while in the Phone Setting selection mode to select Delete.

2 Press the [ENTER] button.

3 Press the [SELECT] (Up/Down) button to select Phonebook.

4 Press the [ENTER] button.

5 Press the [SELECT] (Up/Down) button to select ALL, a name, or a phone number.

ALL:

Deletes entire phonebook.

Name or phone number:

Only the selected data is deleted.

6 Press the [ENTER] button.

If ALL is selected "DELETE?" and "ALL" will be displayed.

If a name or phone number is selected "DELETE?" and the name or phone number will be displayed.

7 Press the [ENTER] button.

8 When the data in the phonebook has been deleted, "COMPLETED" will be displayed.

Deleting call history

1 Press the [SELECT] (Up/Down) button while in the Phone Setting selection mode to select Delete.

2 Press the [ENTER] button.

- 3** Press the [SELECT] (Up/Down) button to select **Outgoing Calls** or **Incoming Calls**.

Outgoing Calls:
Outgoing call history

Incoming Calls:
Incoming call history

- 4** Press the [ENTER] button.

If **Outgoing Calls** is selected "DELETE?" and "Outgoing Calls" will be displayed.

If **Incoming Calls** is selected "DELETE?" and "Incoming Calls" will be displayed.

- 5** Press the [ENTER] button.

- 6** When the data in the call history has been deleted, "COMPLETED" will be displayed.

Deleting preset dial

- 1** Press the [SELECT] (Up/Down) button while in the Phone Setting selection mode to select **Delete**.

- 2** Press the [ENTER] button.

- 3** Press the [SELECT] (Up/Down) button to select **Preset Dial**.

- 4** Press the [ENTER] button.

"DELETE?" and "Preset Dial" will be displayed.

- 5** Press the [ENTER] button.

- 6** When the data in preset dial has been deleted, "COMPLETED" will be displayed.

Deleting all data

- 1** Press the [SELECT] (Up/Down) button while in the Phone Setting selection mode to select **Delete**.

- 2** Press the [ENTER] button.

- 3** Press the [SELECT] (Up/Down) button to select **ALL**.

- 4** Press the [ENTER] button.

"DELETE?" and "ALL" will be displayed.

- 5** Press the [ENTER] button.

- 6** When the data has been deleted, "COMPLETED" will be displayed.

Changing the passcode

The passcode for the main unit can be changed. 4 to 8 digits must be used. The default setting is 1234.

- 1** Press the [SELECT] (Up/Down) button while in the Phone Setting selection mode to select **Change Code**.

- 2** Press the [ENTER] button.

Passcode and "0*****" will be displayed.

- 3** Press the [SELECT] (Up/Down) button to input numbers between **0** and **9**.

Up:
Increases the number.

Down:
Decreases the number.

- 4 Press the [SELECT] (Right/Left) button to move the cursor.**

Right:

The cursor moves to the right.

Left:

The cursor moves to the left.

- 5 Repeat Steps 3 and 4 to input the passcode to enter the next digit.**

- 6 Press the [ENTER] button when you have input the passcode.**

"NewPasscode?" will be displayed.

- 7 Press the [ENTER] button.**

- 8 "COMPLETED" will be displayed.**

ESN security operating procedure

About ESN

This main unit is equipped with ESN (ECLIPSE Security Network). A music CD (Key CD) which has been registered in the main unit, is necessary for ESN. Without it, none of the functions will operate, even when the battery is reconnected after it has been disconnected for maintenance, or the ignition switch is turned to ACC or ON after it has been turned to OFF. ESN can be set or cancelled using any of the following methods:

- Key CD security

You can register a music CD in the main unit as the "Key CD" to be used to set or cancel the security settings.

How to operate the ESN (Key CD) security

How to program the Key CD

1 Check that the power of the main unit is in standby.

2 While pressing button [6], press the [SCREEN/TEXT] button, and hold both for more than one second.

The "SEC" message appears on the display and changes to the "DISC" message after two seconds.

ATTENTION

- If a CD has already been inserted, a "SEC" message appears, and then the front panel opens and the CD is ejected.
 - If a security is activated, programming the Key CD is not available.
-

3 Press the [**▲** (OPEN/EJECT)] button.

The front panel opens.

4 Insert the Key CD into the disc slot.

A "SEC" message appears, then the Key CD is ejected. The front panel will close automatically.

ATTENTION

- If there is a problem with the inserted CD, an "ERR" message will appear for two seconds and the CD will be ejected. Reinsert the ejected CD.
 - If the "ERR" message appears on the display twice in a row, the "CHANGE" message will be displayed for two seconds. In this case, try another CD.
 - Copy Protected CD and MP3/WMA CD-ROM cannot be programmed for Key CD security.
 - The Security indicator will flash whenever the vehicle's ignition is switched off.
-

How to cancel the Key CD

1 Check that the power of the main unit is in standby.

2 While pressing button [6], press the [SCREEN/TEXT] button, and hold both for more than one second.

The "SEC" message appears on the display and changes to the "DISC" message after two seconds.

3 Press the [**▲** (OPEN/EJECT)] button.

The front panel opens.

**ATTENTION**

If a CD has already been inserted, a "SEC" message appears, and then the front panel opens and the CD is ejected.

4 Insert the Key CD into the disc slot.

"CANCEL" will be displayed and the CD will be ejected. ESN is now deactivated.

**ATTENTION**

If a CD other than the Key CD is inserted, the registration cannot be cancelled. In this case, the "ERR" message is displayed for two seconds, and the CD playback mode is activated.

5 Press the [▲ (OPEN/EJECT)] button.

The front panel closes.

How to change the Key CD**1 First, cancel the existing Key CD.**

Refer to "How to cancel the Key CD".

2 Next, program a new Key CD.

Refer to "How to program the Key CD".

How to resume normal operation (ESN security lock out)

If power is disconnected while ESN security is active (a Key CD was programmed), operation is disabled until power is restored and the main unit unlocked. Follow this procedure to resume normal operation.

1

When the power is turned on after the battery power has been disconnected, the "SEC" message is displayed for two seconds. The message then changes to the "DISC" message. Press the [▲ (OPEN/EJECT)] button.

2

2 Insert the Key CD into the disc slot.

"OK" will be displayed for two seconds and the CD will begin playing.

**ATTENTION**

- If the incorrect CD is inserted, an "ERR_" ("ERR" and error number) message will appear for two seconds, after which the CD will be ejected.
- If the "ERR5" (the 5th time an error has occurred) message appears on the display, the "HELP" message will appear, and the CD will be ejected. When the "HELP" message appears, carry out the operations for ESN security lock out by following the procedure in "What happens if an incorrect CD is inserted?" on page 61.
- You must use the same CD used for Key CD programming; a duplicate CD may not work properly.

X

What happens if an incorrect CD is inserted?**1**

1 After the 5th incorrect attempt, the "HELP" message will be displayed for five seconds.

"HELP" will be displayed for 5 seconds. Then the serial number will be displayed.

2

2 Press the [▲ (OPEN/EJECT)] button to close the front panel.

- 3** While pressing button [6], press the [SCREEN/TEXT] button, and hold both for five seconds.

"SEC" will be displayed for two seconds. Then the six digit rolling code will be displayed.

- 4** Press the [SCREEN/TEXT] button.

"DISC" flashes on the display.

You will have five more attempts to insert correct disc.

- 5** Insert the Key CD into the disc slot.

"OK" will be displayed for two seconds and then the CD will be ejected.



ATTENTION

- If an incorrect CD is inserted, an "ERR_ " ("ERR" and error number) message will appear for two seconds, after which the CD will be ejected.
- This process cancels the protection for ESN main unit.

NOTE

If after 5 tries the correct Key CD is not inserted, the display reads "CALL". Contact Eclipse for assistance.

It is easy to forget the name of your Key CD. Make a note of the album name to remind yourself (refer to page 110).

How to turn the security indicator on/off

Once ESN security is activated, the indicator flashes whenever the vehicle's ignition switch is turned off, warning potential thieves that the main unit is protected. However, if do not want this visible deterrent, it may be turned off.

1

With the main unit in standby, and while pressing button [2], press the [SCREEN] button, and hold both for more than one second.

2

The "IND. FLASH" message or the "IND.-----" message appears on the display.

"IND. FLASH" means the security indicator will flash when the vehicle's ignition switch is off, and "IND.-----" means it will not. Repeat the above steps to reactivate the flash mode.

How to read the Electronic Serial Number

1

Check that the power of the main unit is in standby.

2

While pressing button [4], press the [SCREEN/TEXT] button, and hold both for more than one second.

After the "ESN" message appears on the display, an 8 digit number will appear. This number is the Electronic Serial Number (ESN) of the device. You may use this number to identify your Eclipse CD3200 in the event of theft recovery.

MEMO

How to operate the AUDIO CONTROL

Switching audio control modes

Various audio control modes may be fine-tuned using this procedure.

1 Press the [ENTER] button for less than one second to select the item to be adjusted.

Modes will switch in the order shown below each time the button is pressed.

BASS → MID → TREB → BALANCE → FADER → NON-F*¹ → LOUDNESS → SVC*² → VOL → BASS...

*1: NON-F (non-fader) Output is not affected by the settings of the BASS, MID and TREB.

*2: Setting cannot be made in FM mode.

Mode	Function	Rotary Mode	
		Left	Right
BASS	Adjusts bass level.	Decrease level.	Increase level.
MID (MIDDLE)	Adjusts middle level.	Decrease level.	Increase level.
TREB (TREBLE)	Adjusts treble level.	Decrease level.	Increase level.
SVC (Source Volume Control)	Adjusts different volume levels for each audio mode.	Decrease level.	Increase level.
FADER	Adjusts the audio balance of the front and rear speakers	Emphasizes rear speakers.	Emphasizes front speakers.
BALANCE	Adjusts the audio balance of the right and left speakers	Emphasizes the left speakers.	Emphasizes the right speakers.
NON-F (NON-FADER LEVEL)	Adjusts non-fader level (for subwoofer).	Decrease the sub-woofer level.	Increase the sub-woofer level.
LOUDNESS	The loudness control may be turned on to emphasize low and high frequencies at low volume levels. Loudness boosts bass and treble at low volumes.	Select OFF	Select ON

SVC Setting examples:

The volume for the default FM mode (default value: 40) is used as a reference for storing the differences in volume that have been set for each audio mode.

Audio mode	FM	AM	CD	USB	BT-Audio
Default value (Volume level)	Reference (40)	0 (40)	0 (40)	0 (40)	0 (40)
SVC setting (Volume level)	Reference (40)	SVC setting value -15 (55)	SVC setting value -10 (30)	SVC setting value +5 (45)	SVC setting value -5 (35)
When volume level in FM mode is adjusted from 40 to 45	45	55 → 60	30 → 35	45 → 50	35 → 40
When volume level in CD mode is adjusted from 35 to 60	45 → 70	60 → 80*	60	50 → 75	40 → 65
When volume level in AM mode is adjusted from 80 to 20	70 → 5	20	60 → 0*	75 → 10	65 → 0
When volume level in USB mode is adjusted from 10 to 35	5 → 30	20 → 45	0 → 20	35	0 → 25

*: The volume levels can only be set from 0 (min) to 80 (max). The volume difference can be set within a range of -10 to +20.

How to operate the Sound Adjustment Mode

About Sound Adjustment Mode

The system has several features that allow you to adjust the acoustic characteristics inside the cabin.

Item	Function	Page
PEQ (Parametric EQ)	3-band setting, the frequency, and the Q curve pattern can be adjusted.	69
Position (Position selector)	A preset speaker level for each seat, and the balance can be selected.	70
X-Over (Cross over)	Specified frequency bands are allocated to each speaker for improved sound integration.	70
Non-F setting (Non-fader setting)	The sub-woofer phase can be switched.	71

About parametric EQ

A variety of materials are used inside a vehicle to manufacture the seats and windows, and because these materials absorb and reflect sound in different ways, the parametric equalizer lets you adjust the peaks and dips of the frequency characteristics inside the vehicle to compensate for this.

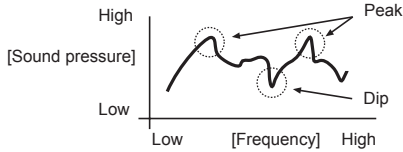

An “equalizer” is a function that corrects these peaks and dips in order to flatten the frequency characteristics. However with a normal graphic equalizer, the median frequency and the Q (sharpness and band width) are fixed, so that when neighboring bands are corrected, there is a limit to the amount by which distortion in the peak and dip characteristics can be corrected. A “parametric equalizer” lets you adjust the median frequency, Q (sharpness and band width) and gain to variable levels, so that you can make fine adjustments to spot areas of the frequency band.

[Parametric equalizer characteristics]

1. Median frequency can be varied.

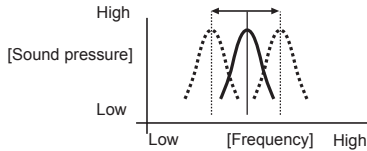

2. Gain can be varied.

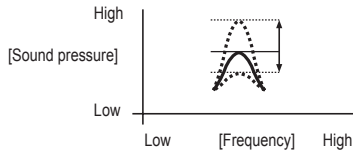

3. Q (sharpness/band width) can be varied.

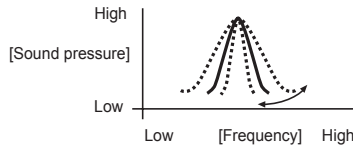

About position selector

From the preset speaker level and Balance/Fader value, the position selector easily provides the listener optimum phase by selecting the seat position.

About crossover

The frequency band that is stored by audio media such as CDs is a fairly wide range from 20 Hz to 20 kHz, and it is difficult for a single speaker to be able to play back all frequencies in such a wide range.

Because of this, several speakers can be used, with different frequency bands (such as treble, medium and bass) allotted to each speaker so that wide frequency ranges can be played back. The “Crossover” function is used to allot the frequency ranges that are to be played back by each speaker in accordance to the installed speaker units and the layout of the speakers, in order to obtain the maximum level of performance from the speakers and to provide the most stable frequency characteristics.

The crossover function includes a high-pass filter (HPF) for playing back treble sounds, and a low-pass filter (LPF) for playing back bass sounds. In addition, the HPF and LPF are used in combination in order to play back sounds in the mid range.

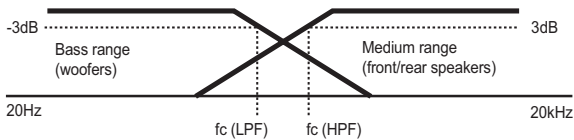

For example, when adjusting the HPF, frequencies that are lower than the specified frequency are progressively dampened, rather than simply not being played back at all. The “slope” adjustment function is the function that is used to adjust these dampening characteristics.

The slope characteristics of a filter are such that with larger slope values (for example 12 dB/oct), the slope becomes steeper, and so the amount of sound mixing in with neighboring bands becomes less so that only the target band is played back. However, it also causes the merging of sound between speakers to become poorer and can result in greater distortion.

- The crossover function is a filter that allocates the specified frequency bands.
- A high-pass filter (HPF) is a filter that cuts out frequencies that are lower than the specified frequency (bass range) and allows higher frequencies (treble range) to pass through.
- A low-pass filter (LPF) is a filter that cuts out frequencies that are higher than the specified frequency (treble range) and allows lower frequencies (bass range) to pass through.
- The slope is the signal level at which frequencies that are one octave higher or one octave lower are dampened.

Switching the sound adjustment mode

1 Press the [/MENU] button for more than one second.
The Menu selection mode is activated.

2 Press the [SELECT] (Up/Down) button to select SOUND.

3 Press the [ENTER] button.
The sound selection mode is activated.

4 Press the [SELECT] (Up/Down) button to select a setting item.
Each time the button is pressed, the setting item changes.

PEQ ↔ Position Sel ↔ X-Over ↔ Non-F Phase ↔ PEQ ...

5 Press the [ENTER] button.
The adjustment mode is switched.

Parametric equalizer adjustment (PEQ)

1 Press the [SELECT] (Up/Down) button to select PEQ.

2 Press the [ENTER] button.
The PEQ setting mode is activated.

Setting preset EQ

1 Press a button from [2] to [6] while the PEQ setting mode is activated.
Pressing the button allows you to toggle through preset EQ modes as follows:

Button	Mode	Patterns
[2]	DEFEAT	No EQ adjustments
[3]	POWER	The pattern that emphasize the bass range.
[4]	SHARP	The pattern that emphasize the treble range.
[5]	VOCAL	The pattern that emphasize the middle range.
[6]	CUSTOM	Custom pattern



ATTENTION

Custom EQ will be overwritten if the value for BASS, MIDDLE and TREBLE are adjusted in the audio control mode. (For details, Refer to "How to operate the AUDIO CONTROL" on page 64.)

XII

Adjusting the median frequency and the Q curve

Frequency level and Q curve for 3 bands (BASS, MIDDLE and TREBLE) can be adjusted separately. Q curve pattern can be chosen from Narrow, Normal, MidWide or Wide for BASS, Narrow or Normal for MIDDLE, and Normal for TREBLE.

1 Press the [ENTER] button to select the band to be adjusted.

Each time the button is pressed, the band changes in the following order.

BASS → MIDDLE → TREBLE → ...

2 Press the [SELECT] (Up/Down) button to adjust the Q curve pattern.

Each time the button is pressed, the Q curve pattern changes in the following order.

When BASS is selected:

WIDE ↔ MidWIDE ↔ NORMAL ↔ NARROW ↔ WIDE ↔ ...

When MIDDLE is selected:

NORMAL ↔ NARROW ↔ NORMAL ↔ ...

When TREBLE is selected:

NORMAL (Fixed)

3 Press the [SELECT] (Right/Left) button to adjust the frequency.

Each time the button is pressed, the frequency changes in the following order.

When BASS is selected:

60Hz ↔ 80Hz ↔ 100Hz ↔ 120Hz ↔ 60Hz ↔ ...

When MIDDLE is selected:

700Hz (fixed)

When TREBLE is selected:

7.5kHz ↔ 10kHz ↔ 12.5kHz ↔ 15kHz ↔ 7.5kHz ↔ ...



ATTENTION

- The median frequency and the Q curve you set are used for BASS, MIDDLE and TREBLE in the audio control mode. (For details, Refer to "How to operate the AUDIO CONTROL" on page 64.)
- When the median frequency and the Q curve are adjusted, CUSTOM EQ is also updated.

Position selector

The sound field can be adjusted for the listener's seat position.

1 Press the [SELECT] (Up/Down) button to select Position Sel.

2 Press the [ENTER] button.

The position selector setting mode is activated.

3 Press the [ENTER] or [SELECT] (Up/Down/Right/Left) button to select the position you want.

When each button is pressed, the position is changed as follows.

ENTER:

OFF

Up:

FRONT

Down:

REAR

Right:

FRONT-RIGHT

Left:

FRONT-LEFT

Crossover adjustment (X-Over)

Specified frequency bands are allocated to each speaker for improved sound integration.

1 Press the [SELECT] (Up/Down) button to select the X-Over.

2 Press the [ENTER] button.

The crossover setting mode is activated.

3 Press the [ENTER] button to select LPF or HPF.

Each time the button is pressed, the setting item changes in the following order.

LPF*1 ↔ HPF*2

*1: The cut-off frequency is 80Hz.

*2: The cut-off frequency is 100Hz.

4 Press the [SELECT] (Up/Down) button to select Slope ON or OFF.

When it is ON, the slope is 12dB/oct.

Non-fader phase (Non-F Phase)

The merging of sound between the front and rear speakers and the woofer can be improved by selecting the phase. Switch the phase to a phase which lets the speakers combine without any disharmony.

1 Press the [SELECT] (Up/Down) button to select Non-F Phase.

2 Press the [ENTER] button.

The mode will change to the non-fader phase mode.

3 Press the [SELECT] (Up/Down) button to select Normal or Reverse.

Up:

Normal

Down:

Reverse

Making changes with Display Adjustment Mode

This mode lets you adjust the display brightness, change the display type, etc.

Switching the Display Adjustment Mode

- 1 Press the [/MENU] button for more than one second.
The Menu selection mode is activated.

- 2 Press the [SELECT] (Up/Down) button to select DISP.

- 3 Press the [ENTER] button.
The display adjustment mode is activated.

- 4 Press the [SELECT] (Up/Down) button to select a setting item.
When the button is pressed, the setting item changes in the following order.

Bright ↔ Illumination ↔ DISP Type ↔
DISP Data ↔ Scroll Type ↔
Bright ↔ ...

- 5 Press the [ENTER] button.
Switches among the adjustment modes.

Switching the brightness (Bright)

Default setting is maximum brightness (5).

- 1 Press the [SELECT] (Up/Down) button to select Bright.

- 2 Press the [ENTER] button.
The bright setting mode is activated.

- 3 Press the [SELECT] (Right/Left) button to adjust the brightness.

Right:
Increases the brightness level.
Left:
Decreases the brightness level.

- 4 Press the [ENTER] button.
The selected settings will take effect.

Changing illumination color

You can change the button illumination color in the following way.

- 1 Press the [SELECT] (Up/Down) button to select Illumination.

- 2 Press the [ENTER] button.
The illumination setting mode is activated.

- 3 Press the [SELECT] (Up/Down) button.
Press the [SELECT] (Up/Down) button to set illumination color as follows:

Blue/Red ↔ Blue/Green ↔ Blue/Amber
↔ All Red ↔ All Green ↔ All Amber ↔
Blue/Red ↔ ...

- 4 Press the [ENTER] button.
The selected settings will take effect.

Changing display type (DISP Type)

The display type (Background or Sound meter) can be changed.

1 Press the [SELECT] (Up/Down) button to select DISP Type.

2 Press the [ENTER] button.

The display type setting mode is activated.

3 Press the [SELECT] (Up/Down) button to select a setting item.

When the button is pressed, the setting item changes in the following order.

Background ↔ Sound Meter ↔
Background ↔ ...

4 Press the [ENTER] button.

Switches among the adjustments modes.

Changing Background (Background)

1 Press the [SELECT] (Up/Down) button to select Background.

2 Press the [ENTER] button.

The background setting mode is activated.

3 Press the [SELECT] (Up/Down) button to select a setting item.

When the button is pressed, the background changes in the following order.

Motion picture1 ↔ Motion picture2 ↔
Motion picture1 ↔ ...

4 Press the [ENTER] button.

The selected settings will take effect.

Changing the sound meter (Sound Meter)

The sound meter type can be changed.

1 Press the [SELECT] (Up/Down) button to select Sound Meter.

2 Press the [ENTER] button.

The sound meter type setting mode is activated.

3 Press the [SELECT] (Up/Down) button to select a setting item.

Each time the button is pressed, the analyzer type changes in the following order.

Type 1 ↔ Type 2

4 Press the [ENTER] button.

The selected settings will take effect.

Importing display data (DISP Data)

Screens can be downloaded from the ECLIPSE website (E-ISERV) and used instead of the pre-set motion pictures. Download the data by following the instructions on the ECLIPSE website (E-ISERV). After you have downloaded the data onto your PC, copy it to a CD-R or a USB memory and import it into the main unit. (URL:<http://www.e-iserv.jp>) Applications for creating motion pictures can be downloaded, allowing you to create your own screen. Screens can be created by following the procedure shown below:

Select several pages of images to use in your picture.



Access The ECLIPSE website.
(URL: <http://www.e-iserv.jp>)



Download ECLIPSE' s original image editing software (Cutting Board) following the instructions provided by the website.



Using the image editing software (Cutting Board), adjust image size to fit the display. To edit images follow the instructions provided with the editing software.



Convert your edited images into moving pictures following the instructions provided by the image editing software (Cutting Board).



Copy the images to a CD-R or a USB memory.



Import into the main unit.

1 Press the [SELECT] (Up/Down) button to select DISP Data.

2 Press the [ENTER] button.

The display data import mode is activated.

3 Press the [SELECT] (Up/Down) button to select the media type.

4 Press the [ENTER] button.

- When using a CD-R:
"INSERT DISC" is displayed, and the front panel opens automatically. If a CD has already been loaded into the main unit, it will automatically eject.
- When using a USB memory:
"CONNECT USB" is displayed until a USB memory is connected to the main unit. When a USB memory containing data has already been connected, the unit starts reading data immediately after pressing the [ENTER] button.

5 Insert the selected media.

6 Press the [▲ (OPEN/EJECT)] button to close the front panel.

7 Press the [SELECT] (Up/Down) button to select a file.

8 Press the [ENTER] button.

9 Press the [SELECT] (Up/Down) button to select the image data you want to overwrite.

10 Press the [ENTER] button.

Start importing the data into the main unit. If the data has already been imported, it will be overwritten. When the data has been imported, the "Completed" message appears. The front panel will open automatically, and the CD-R will be ejected. Press the [▲ (OPEN/EJECT)] button to close the front panel.

⚠ CAUTION

On the CD-R or USB memory, if there is no file whose data type is the one you selected, the "NO DATA" message will be displayed and return to the previous screen.

📖 ATTENTION

- When playing a music file in USB memory, E-iSERV data stored in the USB memory cannot be read into the main unit.
- To load data into the main unit, you have to make a special folder. For detailed information about how to make the folder, refer to the E-iSERV manuals.

⚠ CAUTION

- Do not turn the ignition switch or the power to the main unit ON or OFF (or remove the front panel of the main unit) while data reading is in progress. Data reading will be interrupted and data may be damaged.
- Only the [VOL] button can be operated while the system is reading data.

Changing the scroll type (Scroll Type)

The scroll type of the text display can be changed.

1 Press the [SELECT] (Up/Down) button to select the Scroll Type.

2 Press the [ENTER] button.

The scroll type setting mode is activated.

3 Press the [SELECT] (Up/Down) button to select the scroll type.

Each time the button is pressed, the scroll type changes in the following order.

Once ↔ Repeat

Once:

Scrolls the text once before changing to a fixed display.

Repeat:

Repeats scrolling the text.

The selected settings will take effect.

Making changes with Function Mode

A variety of settings can be changed.

Switching the Function Mode

- 1 Press the [/MENU] button for more than one second.

The Menu selection mode is activated.

- 2 Press the [SELECT] (Up/Down) button to select FUNC, and then press the [ENTER] button.

The function mode is activated.

- 3 Press the [SELECT] (Up/Down) button to select a setting item.

When the button is pressed, the setting item changes in the following order.

STATION NAME*1 ↔ DISC TITLE*2 ↔
GUIDE TONE ↔ Clock ON/OFF ↔
Clock Adjust ↔ Demo ↔ HD RADIO*3
↔ AUX ON/ OFF*4 ↔ AUX Sens*4 ↔
Steering SW ↔ SIRIUS ID*5 ↔ XM ID*6
↔ Phone Setting*7 ↔ BT Audio Set*8

*1: Cannot make settings other than for tuner operation.

*2: Cannot make settings other than for CD/CD changer operation.

*3: This setting can only be chosen when an optional HD Radio tuner unit is connected. (Refer to page 86 for details on HD Radio operation.)

*4: Refer to page 101 for detail on AUX operation.

*5: This setting can only be chosen when an optional SIRIUS Satellite radio tuner unit is connected. (Refer to page 94 for details on SIRIUS Satellite radio operation.)

*6: This setting can only be chosen when an optional XM Satellite radio tuner unit is connected. (Refer to page 90 for details on XM Satellite radio operation.)

*7: For details, refer to "Setting the Bluetooth hands-free function" on page 52.

*8: For details, refer to "Bluetooth audio setup" on page 38.

Setting a station name/disc title

The name of the station being received, or the title of the CD being played can be set.

ATTENTION

Not available with HD-Radio or SAT radio.

- 1 Press the [SELECT] (Up/Down) button to select Station Name or Title.

Station Name or Title will be selected based on the current audio mode settings.

- 2 Press the [ENTER] button.

The title setting mode is activated.

- 3 Press the [SCREEN/TEXT] button to select the character type.

Pressing the button will switch types from [ABC] (upper-case alphabet characters) to, [123] (numeric characters) and then [!@#] (symbols).

4 Press the [SELECT] (Right/Left) button to select the positions where characters will be input.

The character will be inserted where the cursor is flashing.

Right:

Advances the cursor to the right.

Left:

Returns the cursor to the left.

5 Press the [SELECT] (Up/Down) button to select characters.

Up:

Moves the character forward in its type.

Down:

Moves the character backward in its type.

[Symbol] First character [!]
 ! ↔ “ ↔ # ↔ \$ ↔ % ↔ & ↔ ' ↔ (↔) ↔ * ↔ + ↔ , ↔ - ↔ . ↔ / ↔ : ↔ ; ↔ < ↔ = ↔ > ↔ ? ↔ @ ↔ ' ↔ _ ↔ ! ↔ ...

[Upper-case alphabet characters] Initial value [A]
 A ↔ B ↔ C ↔ ... ↔ X ↔ Y ↔ Z ↔ A ↔ ...

[Numeric characters] Initial value [1]
 1 ↔ 2 ↔ 3 ↔ ... ↔ 8 ↔ 9 ↔ 0 ↔ 1 ↔ ...

6 Press the [ENTER] button to save the title.

 **ATTENTION**

- To change the type of character to be entered, repeat steps 3 and 5.
- A maximum of 16 characters may be entered per title.
- 30 titles can be stored.
- When the data storage area is full, the "FULL DATA" message appears. If new data is input, the older data will be deleted.

Deleting a station name/disc title

1 Press the [RTN/BAND] button for more than two seconds while the title setting mode is activated.

The station name/disc title that is displayed at this point will be deleted.

Setting the guide tone

The main unit is set at the factory to emit a beep tone in response to button operation. The guide tone feature may be disabled in the following procedure:

1 Press the [SELECT] (Up/Down) button to select Guide Tone.

2 Press the [ENTER] button.

The guide tone setting mode is activated.

3 Press the [SELECT] (Up/Down) button to select Guide Tone ON/OFF.

Setting clock display (Clock ON/OFF)

Switches the clock display to ON/OFF.

1 Press the [SELECT] (Up/Down) button to select Clock ON/OFF.

2 Press the [ENTER] button.

The clock display setting mode is activated.

- 3 Press the [SELECT] (Up/Down) button to set the clock display to ON or OFF.**



ATTENTION

The clock display can also be turned on and off by pressing the button [6] while the power is turned off.

Setting time (Clock Adjust)

This main unit uses the 12-hour display notation.

- 1 Press the [SELECT] (Up/Down) button to select Clock Adjust.**

- 2 Press the [ENTER] button.**

The clock setting mode is activated.

- 3 Press the [SELECT] (Right/Left) button to select the item to be adjusted.**

Right:

Minutes will be switched.

Left:

Hours will be switched.

- 4 Press the [SELECT] (Up/Down) button to adjust the time.**

Up:

Turns the time forward.

Down:

Turns the time back.

- 5 Press the [ENTER] button.**

Switching demonstration screen display (Demo)

Demonstration screen display settings can be performed. Default setting is ON.

If the demonstration screen display is set to ON, operation, motion picture, and other screens will be displayed in succession.

If you press a button while the demonstration screens are being displayed, the demonstration screens will be cancelled and the audio operation screen will be displayed. If you do not operate the status display function within 15 seconds, the display will return automatically to the demo screen.

- 1 Press the [SELECT] (Up/Down) button to select Demo.**

- 2 Press the [ENTER] button.**

The demo display setting mode is activated.

- 3 Press the [SELECT] (Up/Down) button to select Demo ON/OFF.**

Setting the steering remote function (U.S.A. only)

The vehicle's factory loaded steering remote becomes inoperable when the CD3200 is installed. The ECLIPSE website (E-iSERV) provides software that enables steering remote operation even with the installation of the main unit. Import this software into your CD3200.

For details, contact the store from which you purchased your main unit. Depending on your vehicle's make and model, material downloaded from the website may not be compatible with your steering remote. Consult the store from which you purchased your CD3200 about compatibility and set-up procedures. Software for the steering remote can be downloaded and imported into the main unit as follows:

Access The ECLIPSE website.
(URL: <http://www.e-iserv.jp>)



Download the steering remote software following instructions provided on the ECLIPSE website (E-iSERV). (Because material available on the website may not be compatible with the steering remotes found on some automobiles, make sure to check the website for details about compatibility.)



Copy the downloaded software to CD-R or a USB memory.



Import into the main unit.



The steering remote can be operated.

Reading steering remote data (U.S.A. only)

The steering remote data that has been downloaded from E-iSERV (website) to a USB memory or CD-R can be loaded into the main unit and save there.

1 Press the [SELECT] (Up/Down) button to select Steering SW.

2 Press the [ENTER] button.

The steering remote setting mode is activated.

3 Press the [SELECT] (Up/Down) button to select the media type.

4 Press the [ENTER] button.

When using a CD-R:

"INSERT DISC" will be displayed and the front panel will open automatically.

When a USB memory is used:

The "CONNECT USB" message will be displayed until the USB memory is connected.

5 Insert the CD-R or connect the USB memory to save the steering remote data.

6 Press the [▲] (OPEN/EJECT) button to close the front panel.

7 Press the [SELECT] (Up/Down) button to select a file.

8 Press the [ENTER] button.

The CD-R or USB memory data is read. While it is reading, "READING" is displayed.

If the data can be read successfully, "COMPLETED" will appear on the display. When using CD-R data, the CD-R will automatically eject when reading is complete.



ATTENTION

- To load data into the main unit, you have to make a special folder. For detail information about how to make the folder, refer to the E-iSERV website.
 - This function is available only for vehicles equipped with steering remote with an interface that operates by detecting voltage
 - When playing a music file in USB memory, E-iSERV data stored in the USB memory cannot be read into the main unit.
-



CAUTION

- Do not turn the ignition switch or power to the main unit ON or OFF (or remove the front panel of the main unit) while data reading is in progress. Data reading will be interrupted and data may be damaged.
- Only the [VOL] button can be operated while the system is reading data.

Compatibility with various switches

The compatibility of the main unit's various modes and the steering remotes installed on your vehicle are as follows:

Switch Name*1	Button function	Mode						
		Tuner	Disc/USB mode	AUX	iPod	Power OFF	BT-Audio mode	BT-TEL mode
TRACK+	Press briefly	TUNE UP	TRACK UP	—	TRACK UP	—	TRACK UP	—
	Press and hold	SEEK UP*2	FAST UP	—	FAST UP	—	FAST UP	—
TRACK-	Press briefly	TUNE DOWN	TRACK DOWN	—	TRACK DOWN	—	TRACK DOWN	—
	Press and hold	SEEK DOWN*2	FAST DOWN	—	FAST DOWN	—	FAST DOWN	—
VOL+	Press briefly	Increases the volume	Increases the volume	Increases the volume	Increases the volume	—	Increases the volume	Increases the volume (ring tone/speakers' voices)
	Press and hold	Gradually increases volume	Gradually increases volume	Gradually increases volume	Gradually increases volume	—	Gradually increases the volume	Increases the volume gradually (ring tone/speakers' voices)
VOL-	Press briefly	Decreases the volume	Decreases the volume	Decreases the volume	Decreases the volume	—	Decreases the volume	Decreases the volume (ring tone/speakers' voices)
	Press and hold	Gradually decreases volume	Gradually decreases volume	Gradually decreases volume	Gradually decreases volume	—	Gradually decreases the volume	Decreases the volume gradually (ring tone/speakers' voices)
MODE	Press briefly	Switches to the next mode	Switches to the next mode	Switches to the next mode	Switches to the next mode	Power ON in the last mode	Switches to the next mode	Switches to the next mode
	Press and hold							
MUTE	Press briefly	MUTE	MUTE	MUTE	MUTE	—	MUTE	—
	Press and hold	—	—	—	—	—	—	—
POWER	Press briefly	Power OFF	Power OFF	Power OFF	Power OFF	Power ON in the last mode	Power OFF	Power OFF
	Press and hold	—	—	—	—	—	—	—

XIV

Various Settings

Switch Name ^{*1}	Button function	Mode						
		Tuner	Disc/USB mode	AUX	iPod	Power OFF	BT-Audio mode	BT-TEL mode
ON HOOK	Press briefly	—	—	—	—	—	—	ON HOOK
	Press and hold	—	—	—	—	—	—	—
OFF HOOK	Press briefly	The TEL mode is activated.	The TEL mode is activated.	The TEL mode is activated.	The TEL mode is activated.	The TEL mode is activated.	The TEL mode is activated.	OFF HOOK
	Press and hold	—	—	—	—	—	—	—

*1: Switch names change depending on vehicle make and model.

*2: If a SIRIUS/XM satellite radio tuner (purchased separately) is connected, categories can be switched when in the satellite mode.

MEMO

How to operate the main unit with an optional CD changer connected

This section covers the operation of an optional CD changer that is connected to the main unit.

Listening to a CD

1 Switch to CD changer mode.

For details, refer to "Switching Audio Modes" on page 18.

Advancing to the next track or returning to the beginning of the track being played

1 Press the [SELECT] (Right/Left) button for less than one second.

Right:

Advances to the next track.

Left:

Returns to the beginning of the track being played.

(Repeat pressing for previous tracks.)

Operations during rotary mode

1 Turn the [VOL] button.

Turn to the right:

Advances to the next track.

Turn to the left:

Return to the beginning of the track being played.

Repeat turning for previous tracks.

Fast Forward/Rewind

Fast forward or rewind the song currently being played.

1 Press and hold the [SELECT] (Right/Left) button.

Right:

Fast forward.

Left:

Rewind.

Playing the beginning of tracks (SCAN)

1 Press the [4 SCAN] button.

Pressing the button for less than one second causes the changer to move up to the next track and play it for 10 seconds, then move up to the next track and play it for 10 seconds, and so on, on one CD, until the button is pressed again.

Press the button for longer than a second to play the first 10 seconds of the first track of every CD loaded.



ATTENTION

- To continue playing a desired track, press the button again to stop scanning.
 - After the entire disc is scanned once, ordinary playback starts from the point where scanning started.
-

Repeating the same track (REPEAT)

1 Press the [5 RPT] button.

Pressing on the button for less than one second causes the changer to repeat the track currently being played, until the button is pressed again. Press the button for longer than a second to repeat all tracks on the CD being played.

Press the button for more than one second to repeat all the tracks on the CD being played.

Playing tracks in random order (RANDOM)

1 Press the [6 RAND] button.

Pressing on the button for less than one second causes the changer to play the tracks on the currently playing CD in random order, until the button is pressed again.

Press the button for longer than a second to play tracks from all of CDs loaded in the currently selected changer, in random order. Tracks can be repeated during random play. This is not an abnormal occurrence.

ATTENTION

- During random playback, press the [5 RPT] button to repeat the track being played. To cancel the repeat play (and return to random play), press the [5 RPT] button again.

- When any of the functions - "Playing the beginning of tracks", "Repeating the same track" or "Playing tracks in random order" - is selected, a message such as "SCAN", "ALL SCAN", "REPEAT", "ALL REPEAT", "RANDOM" or "ALL RANDOM" will appear on the display to verify the current function.
- Random play is not cancelled even if a magazine is ejected.

Skipping to the next or previous CD

1 Press the [SELECT] (Up/Down) button.

Up:

Selects the next higher number disc.

Down:

Selects the next lower number disc.

Specifying a CD to play

A CD of your choice is directly selectable out of the loaded discs.

1 Press the [MODE] button for more than one second.

2 Press a button from [1] to [6].

Buttons	1	2	3	4	5	6
CD	1	2	3	4	5	6
	7	8	9	10	11	12

To select a CD from nos. 7 to 12, press the desired button considerably longer.

3 Press the [MODE] button for more than one second to exit the direct selection mode.

How to operate the tuner with an optional HD Radio tuner connected (U.S.A. only)

About HD Radio

If the optional HD Radio tuner unit is connected, terrestrial digital broadcasts can be received. When terrestrial digital broadcasts are received, the FM reception has the same sound quality as a CD, and the AM reception has the same sound quality as conventional FM sound. Depending on the reception status, HD Radio may also be able to receive analog broadcasts, which means reception is still possible in regions with no digital coverage.

There are both automatic and manual methods (one of each) for storing stations in memory. The main unit can store up to 24 stations in memory. There are 6 stations for AM and 18 stations for FM (6 each for FM1, FM2 and FM3) (initial settings).

See "How to operate the tuner" on page 42 for information on the following operations:

- Listening to the tuner
- Tuning to a station
- Entering stations into memory automatically (The automatic preset mode: ASM)
- Manually setting stations into memory
- Preset station scan

During digital broadcast reception, the "DIGITAL" message appears on the display.

Switching between displays when receiving HD Radio

During digital reception, the name of the station being received and other information can be displayed.

1 Press the [SCREEN/TEXT] button for more than one second.

Each press will switch the display items in the following sequence:
station name → title* → artist* → album* → genre.

*: Depending on the nature of the broadcast, no information may be shown.

HD Radio reception settings

The HD Radio reception method can be selected. When the HD Radio tuner is connected to this main unit for the first time, it will be set at [AUTO] (automatic digital/analog selection).

1 Press the [MENU] button for more than one second.

The Menu selection mode is activated.

2 Press the [SELECT] (Up/Down) button to select FUNC, and then press the [ENTER] button.

The function mode is activated.

3 Press the [SELECT] (Up/Down) button to select HD Radio.

4 Press the [ENTER] button.

The reception setting screen is displayed.

5 Press the [SELECT] (Up/Down) button to select Auto or OFF.

In the [Auto] setting, the selection is switched between digital and analog reception automatically. In areas where digital reception is not possible, reception is automatically switched to analog to avoid loss of reception. While receiving the digital broadcast, the "DIGITAL" message appears on the display. This is cleared during analog reception.

In the [OFF] setting, reception is always analog.

How to operate the tuner with an optional XM satellite radio tuner connected (U.S.A./CANADA only)

About XM satellite radio

If the optional XM satellite radio tuner unit is connected, satellite radio broadcasts can be received.

With XM satellite radio, over 170 channels are available including music, sports, news, and entertainment programs.

The channel can be selected from categories such as ROCK and DANCE, or by selecting individual channels manually.

Reception of XM satellite radio is fee based; you have to subscribe to it.

It is possible to subscribe through the XM radio website.

URL: <http://www.xmradio.com>



ATTENTION

- For details on the settings and operation of the XM satellite radio tuner unit, refer to the XM satellite radio unit owner's manual.
 - The main unit will accept up to 24 stations in memory.
-

Selecting the radio mode

1 Switch to the XM satellite radio mode.

For details, refer to "Switching Audio Modes" on page 18.

Selecting a channel

1

Press the [RTN] button for less than one second to switch to the desired XM band.

The radio bands will switch from XM1 → XM2 → XM3 → XM4 in order each time the button is pressed.

2

Press the [SELECT] (Right/Left) button to tune to a channel.

Right:
Selects a higher channel.

Left:
Selects a lower channel.

3

Press the [SELECT] (Right/Left) button for more than one second to start an automatic channel search.

Reception is enabled for all channels within the currently selected category.

(Refer to page 89 for details on "Category selection".)

Right:
Starts searching for higher channels.

Left:
Starts searching for lower channels.

Operations during rotary mode

1 Turn the [VOL] button to the left or right.

Turn to the right:
Tunes to higher channels.

Turn to the left:
Tunes to lower channels.

Category selection

The channel can be selected from among categories such as ROCK and DANCE.

Consult the XM website for the details of the categories.

1 Press the [SELECT] (Up/Down) button for less than one second.

The category will switch in the order shown below each time button is pressed.

Up:
Advances to the next category.

Down:
Returns to the previous category.

Direct channel selection

The channel can be selected by inputting the channel directly.

1 Press the [MODE] button for more than one second.

The mode will change to the direct channel selection mode.

2 Press the [SELECT] (Right/Left) button to select the channel number.

Right:
Advances to the next number.

Left:
Returns to the previous number.

3 Press the [SELECT] (Up/Down) button to select the channel number to be input.

Each time the button is pressed, the channel number changes in the following order.

0 ↔ 1 ↔ 2 ↔ 3 ↔ 4 ↔ 5 ↔ 6 ↔ 7 ↔
8 ↔ 9 ↔ 0 ↔ ...

4 Press the [ENTER] button.

Reception starts.

Manually setting channels into memory

This section covers the storing of stations in the memory of numbered buttons.

1 Press the [SELECT] (Right/Left) button to tune to the channel to be stored in the memory.

2 Select any button, from [1] to [6], and press it for more than two seconds.

The tuned channel is now memorized and set in the button selected. Repeat the procedure to set additional manually tuned channels into memory, in turn, for buttons [1] to [6]. These buttons are called the preset buttons.



ATTENTION

If the vehicle's battery is disconnected (for repairs to the vehicle or when removing the main unit), all channels stored in memory will be lost. In such cases, set the channels into memory again.

Preset channel scan

This function enables the reception of all the channels in the preset buttons for five seconds each.

- 1 Press the [SELECT] (Down) button for more than one second.**

[P SCAN] will appear on the display, and channels set in preset buttons [1] through [6] will be received for five seconds each.

- 2 To stop the preset scan mode at the desired channel, press the [SELECT] (Down) button again.**

The main unit will stay tuned to the desired channel.

Switching displays when using the XM satellite radio

- 1 Press the [SCREEN/TEXT] button for more than one second.**

Each time the button is pressed the display item changes in the following order:

channel name → category name → title → name → channel name → …

ATTENTION

If there are no names, the "NO DATA" message will appear.

Displaying the XM ID

Displays the XM ID. The XM ID is necessary when subscribing to programs, etc.

- 1 Press the [PHONE/MENU] button for more than one second.**

The Menu selection mode is activated.

- 2 Press the [SELECT] (Up/Down) button to select FUNC, and then press the [ENTER] button.**

- 3 Press the [SELECT] (Up/Down) button to select XM ID.**

- 4 Press the [ENTER] button.**

The XM ID is displayed.

MEMO

How to operate the tuner with an optional SIRIUS satellite radio tuner connected (U.S.A./CANADA only)

About SIRIUS satellite radio

If the optional SIRIUS satellite radio tuner unit is connected, satellite radio broadcasts can be received.

With SIRIUS satellite radio, over 130 channels are available, including music, sports, news, and entertainment programs.

The channel can be selected from categories such as POP and ROCK, or by selecting individual channels manually.

Reception of SIRIUS satellite radio is fee based; you have to subscribe to it.

It is possible to subscribe through the SIRIUS radio website.

URL: <http://www.sirius.com>



ATTENTION

- For information about the operation and set-up of the SIRIUS satellite radio tuner unit, see the SIRIUS satellite radio unit's owner's manual.
 - The main unit will accept up to 24 stations in memory.
-

Selecting the radio mode

1 Switch to the SIRIUS satellite radio mode.

For details, refer to "Switching Audio Modes" on page 18.

Selecting a channel

1

Press the [RTN] button for less than one second to switch to the desired SR band.

Each time the button is pressed, the radio band changes in the order SIRIUS1 → SIRIUS2 → SIRIUS3 → SIRIUS4.

2

Press the [SELECT] (Right/Left) button to tune to a channel.

Right:

Selects a higher channel.

Left:

Selects a lower channel.

3

Press the [SELECT] (Right/Left) button for more than one second to start an automatic channel search.

Reception is enabled for all channels within the currently selected category. (Refer to page 93 for details on "Category selection".)

Right:

Starts searching for higher channels.

Left:

Starts searching for lower channels.

Operations during rotary mode

1

Turn the [VOL] button to the left or right.

Turn to the right:

Tunes to higher channels.

Turn to the left:

Tunes to lower channels.

Category selection

The channel can be selected from among categories such as POP and ROCK.

Consult the SIRIUS website for the details of the categories.

1 Press the [SELECT] (Up/Down) button for less than one second.

The category will switch in the order shown below each time button is pressed.

Up:

Advances to the next category.

Down:

Returns to the previous category.

Direct channel selection

The channel can be selected by inputting the channel directly.

1 Press the [MODE] button for more than one second.

The mode will change to the direct channel selection mode.

2 Press the [SELECT] (Right/Left) button to select the channel number.

Right:

Advances to the next number.

Left:

Returns to the previous number.

3 Press the [SELECT] (Up/Down) button to select the channel number to be input.

Each time the button is pressed, the channel number changes in the following order.

0 ↔ 1 ↔ 2 ↔ 3 ↔ 4 ↔ 5 ↔ 6 ↔ 7 ↔
8 ↔ 9 ↔ 0 ↔ ...

4 Press the [ENTER] button.

Reception starts.

Manually storing channels into memory

This section covers the storing of stations in the memory of numbered buttons.

1 Press the [SELECT] (Right/Left) button to tune to the channel to be stored in the memory.

2 Select any button, from [1] to [6], and press it for more than two seconds.

The tuned channel is now memorized and stored in the button selected. Repeat the procedure to stored additional manually tuned channels into memory, in turn, for buttons [1] to [6]. These buttons are called the preset buttons.



ATTENTION

If the vehicle's battery is disconnected (for repairs to the vehicle or when removing the main unit), all channels stored in memory will be lost. In such cases, store the channels in memory again.

Preset channel scan

This function enables the reception of all the channels in the preset buttons for five seconds each.

1 Press the [SELECT] (Down) button for more than one second.

[P SCAN] will appear on the display, and channels stored in preset buttons [1] through [6] will be received for five seconds each.

- 2 To stop the preset scan mode at the desired channel, press the [SELECT] (Down) button again.**

The main unit will stay tuned to the desired channel.

Switching displays when using the SIRIUS satellite radio

- 1 Press the [SCREEN/TEXT] button for more than one second.**

Each time the button is pressed the display item changes in the following order:

channel name → category name → title → artist → channel name → ...



ATTENTION

If there are no names, the "NO DATA" message will appear.

Displaying the SIRIUS ID

Displays the SIRIUS ID. The SIRIUS ID is necessary when subscribing to programs, etc.

- 1 Press the [MENU] button for more than one second.**

The Menu selection mode is activated.

- 2 Press the [SELECT] (Up/Down) button to select FUNC, and then press the [ENTER] button.**

- 3 Press the [SELECT] (Up/Down) button to select SIRIUS ID.**

- 4 Press the [ENTER] button.**

The SIRIUS ID is displayed.

MEMO

How to operate the main unit with an optional Interface Adapter for iPod connected

An iPod can be connected to the main unit using the optional Interface Adapter for iPod (iPC-106), allowing you to listen to iPod music files and operate some iPod functions from the main unit. For details on connecting the Interface Adapter for iPod, as well as settings and other information, refer to the OWNER'S MANUAL of the Interface Adapter for iPod.

iPod is for legal or right holder-authorized copying only. Don't steal music. iPod is a trademark of Apple Computer, Inc., registered in the U.S. and other countries.

Listening to iPod music files (If an iPod is not connected)

1 Connect the iPod using the optional Interface Adapter for iPod.

The iPod will begin playing once it is connected.

ATTENTION

- The iPod will begin playing the music file it was playing before being connected. If the main unit cannot detect the music file that was playing previously, it will begin playing from the first music file.
 - When the iPod is connected using the optional iPod Interface Adapter, the "ECLIPSE" message will be displayed on the iPod. While the "ECLIPSE" message is displayed, the iPod cannot be operated directly.
-

CAUTION

- Disconnect headphones and all other accessories from the iPod before connecting it to the optional Interface Adapter for iPod. Failure to do so may make it impossible to operate the iPod from the main unit.
- If the iPod's equalizer has been customized, the sound output may be distorted when it is connected to the optional Interface Adapter for iPod.

Listening to iPod music files (If an iPod is connected)

1 Switch to the iPod mode.

For details, refer to "Switching Audio Modes" on page 18.

Advancing to the next music file or returning to the beginning of the music file being played

1 Press the [SELECT] (Right/Left) button for less than one second.



Right :

Advances to the next music file.



Left :

Returns to the beginning of the music file being played. (Repeat pressing for previous music files.)

Fast forward/rewind

1 Press and hold the [SELECT] (Right/Left) button.



Right :

Fast forwards.



Left :

Rewinds.

Searching for a music file

The iPod search mode can be operated from the main unit.

1 Press the [MODE] button.



The search mode is activated.

2 Turn the [VOL] button to select the search mode item.



Search mode items are selected in the following order.

Playlists ↔ Albums ↔ Artists ↔ Genres ↔ Songs ↔ Playlists

3 Press the [ENTER] button.



The following information is displayed according to the selected search mode item.

Playlists:

The playlist selected on the iPod is displayed

Artists:

Artist names are displayed

Albums:

Album names are displayed

Songs:

Music file names are displayed

Genres:

Genre names are displayed

4 Turn the [VOL] button to select the desired search mode item, and then press the [ENTER] button.



If SONGS is selected, the selected song will be played. If another search mode item is selected, continue the selection process until you have selected a song.

All files in the selected list (playlist, artist, album or genres) will be played back and repeated.

After selecting the desired search mode item (ARTIST, ALBUM or GENRES), press button [1] to play back all files in that item. No files can be played back even if button [1] is pressed after selecting PLAY LIST.

5 Press the [SELECT] (Up/Down) button.



(Up):

10 tracks backward



(Down):

10 tracks forward

ATTENTION

- Each search item mode will display information in the following order before displaying music file information.

Search mode	Display order
Playlists:	Playlists → Songs
Artists:	Artists → Albums → Songs
Albums:	Albums → Songs
Genres:	Genres → Artists → Albums → Songs
Songs:	Songs

- The ALL option on iPod is displayed in the Playlists search mode. Select Playlists to play back all files.

Repeating the same music file (REPEAT)

1 Press button [5].

RPT

5 :

Pressing this button causes the iPod to repeat the music file currently being played, until the button is pressed again.

Playing music files in random order (SHUFFLE)

1 Press button [6].

RAND

6 :

Pressing this button for more than one second causes the iPod to play the music files on the album currently being played in random order, until the button is pressed again.

Press the button for less than one second to play all the iPod music files currently being played in random order.

ATTENTION

- When either of the functions- REPEAT or RANDOM is selected, a message such as "RPT", "ALL-RAND" or "RAND" appears on the display to verify the current function.
 - REPEAT and RANDOM both operate in the same manner as the REPEAT and SHUFFLE modes on iPod.
-

Displaying text

The display can be switched to show the album name, the artist name and the song name.

1 Press the [SCREEN/TEXT] button for more than one second.

TEXT

SCREEN :

The album name, the artist name and the song name are scrolled and displaying, the information is displayed in the following order.

Song → Artist → Album → Song...

ATTENTION

- Text recorded with characters other than alphanumeric characters and symbols cannot be displayed.
 - Characters that cannot be displayed are displayed as * (asterisks).
 - If there is no text stored in a music file, the "NO DATA" message will appear.
-

MEMO

Others

Connecting a portable audio player to the AUX jack

Use a commonly available accessory cable with an RCA connector or an optional AUX105 to connect a portable audio player to the AUX (auxiliary) jack of this system.

There are 2 connection terminals on this main unit; one for the RCA connector and the other for the optional LAN cable (AUX 105). The default setting for AUX is OFF.

1 Turn on the portable audio player and start its play function.

The AUX mode is activated.

For details, refer to "Switching Audio Modes" on page 18.

ATTENTION

- While the AUX mode is activated, actions such as turning off the audio player or pulling out the connection cord may cause noise spikes that can damage the system speakers. Be sure to avoid this possibility by turning off system power or switching from the AUX mode to another mode before shutting off or disconnecting the portable audio player.
 - Audio output levels for the various devices that can be connected using this method will differ. Carefully adjust the volume until the output level of the connected player is known.
 - Before using a portable audio player in a vehicle, read the player's operation manual carefully and confirm problem-free operation in the vehicle before proceeding.
 - When you connect an optional LAN cable (AUX 105) to the main unit, other optional equipment that uses E-LAN cannot be connected.
-

Switching the AUX mode on and off

1 Press the [MENU] button for more than one second.

The Menu selection mode is activated.

2 Press the [SELECT] (Up/Down) button to select FUNC, and then press the [ENTER] button.

The function mode is activated.

3 Press the [SELECT] (Up/Down) button to select AUX ON/OFF.

The AUX ON/OFF mode is activated.

4 Press the [SELECT] (Up/Down) button to select the ON/OFF mode.

Press the button to switch the mode as follows:

Up:

Mode is ON

Down:

Mode is OFF

The selected settings will take effect.

Switching the input system

When using an optional AUX cord (AUX105), the main unit can be switched between RCA input and optional AUX cord (AUX105) input.

1 Press the [MODE] button for more than one second.

The system will switch between RCA input and optional AUX cord input each time the button is pressed.

RCA input (INPUT) ↔ Optional AUX cord (SUB INPUT)

Changing auxiliary input sensitivity

The sensitivity of the auxiliary mode can be changed.

- 1 Press the [MENU] button for more than one second.**

The Menu selection mode is activated.

- 2 Press the [SELECT] (Up/Down) button to select FUNC, and then press the [ENTER] button.**

The function mode is activated.

- 3 Press the [SELECT] (Up/Down) button to select AUX Sens.**

The AUX sensitivity mode is activated.

- 4 Press the [SELECT] (Up/Down) button to select the sensitivity mode.**

Pressing the button allows you to toggle through sensitivity modes as follows:

Low ↔ Mid ↔ Hi ↔ Low ↔ ...

The selected settings will take effect.

If you have a question:



[RESET] button

Check the items mentioned below before attempting to troubleshoot problems.

CAUTION

If a problem occurs, for instance when the main unit does not respond to any button presses, or the display doesn't work correctly, press the [RESET] button using a paper clip or similar item. Pressing the [RESET] button will delete all the entries from memory. The settings will return to those made at the factory prior to shipment.

Displayed information (for troubleshooting)

The information listed in the chart below is displayed to show the status of the CD, USB memory, XM Radio, Sirius Radio, iPod, CD changer or Bluetooth, etc. Refer to the chart for details of the appropriate remedial action to be taken.

Information	Explanation and remedial action
INFO 1 CD PLAYER SHUTTER IS OPEN	Close the shutter.
INFO 2 NO DISC IN THE MAGAZINE	There is no disc in the magazine or player. Load a disc into the magazine. (Load a music disc.)
INFO 3 DISC IS DIRTY OR DAMAGED	The loaded disc is dirty or upside down. Check its orientation and whether it is clean.
INFO 5 CD PLAYER AND CD CHANGER MECHANICAL FAILURE IS OCCURRING	<ul style="list-style-type: none"> The CD player and CD changer are inoperative for some reason. Go through the magazine removal procedure. If the magazine fails to eject, have your dealer fix the problem. For the CD player, press and hold the [▲] (OPEN/EJECT) button for more than 5 seconds. If no response, contact your dealer.
INFO 6 INTERNAL TEMPERATURE OF CD PLAYER AND CD CHANGER IS HIGH (PICKUP UNIT PROTECTION)	<ul style="list-style-type: none"> The temperature in the CD player and CD changer is too high for operation. Wait till they cool down. Resume playback after the "High temperature sensed and CD stopped" display disappears. If the CD still cannot be played, have your dealer fix the problem.

Information		Explanation and remedial action
INFO 7	INTERNAL POWER SUPPLY FAILURE IS OCCURRING	<ul style="list-style-type: none"> Turn the ACC off, and then turn it on again to resume the operation. If this condition persists, please contact your dealer.
LOAD		The CD changer is in the process of verifying the presence of CDs after a magazine has been inserted into the CD changer.
FILE ERR	NO VALID FILE IN CD-R OR USB MEMORY	Confirm the file.
NO SUPPORT DEVICE	USB MEMORY FORMAT NOT SUPPORTED	Confirm the USB memory standards.
USB ERR	PROBLEM WITH DATA TRANSMISSION	Confirm the USB memory connection.
ANTENNA	XM ANTENNA IS DISCONNECTED	Connect the XM antenna.
NO SIGNAL	XM Satellite RADIO SIGNAL RECEPTION FAILURE	Move to a place where a good signal can be received.
OFF AIR	NO BROADCASTING ON SELECTED CHANNEL	Select another channel.
CHANNEL---	UNRECEIVABLE CHANNEL OR NO AVAILABLE CHANNEL IN SELECTED CATEGORY	Select another channel.
INVALID	NO RECEIVABLE CHANNEL	Select another channel.
ANTENNA	Sirius ANTENNA IS DISCONNECTED	Connect the Sirius antenna.
CALL 888-539-SIRIUS	NO SUBSCRIPTION TO THE SELECTED CHANNEL	Subscribe to Sirius to receive Sirius Satellite radio services.
ACQUIRING	Sirius Satellite RADIO SIGNAL RECEPTION FAILURE	Move to a place where a good signal can be received.
NO iPod	iPod IS NOT CONNECTED	Make sure the iPod is connected correctly.
READING...	iPod IS TRANSMITTING DATA	Wait until the message disappears before operating.
NO DATA	NO MUSIC FILES STORED IN iPod	Check the files stored in the iPod.
ERROR1	iPod STOPS TRANSMITTING DATA FOR SOME REASON	Check the iPod connection.
ERROR2	iPod SOFTWARE NOT SUPPORTED	Check the iPod software.
OUTGOING ERROR	TRANSMISSION IS IMPOSSIBLE.	Check whether the cell phone is connected and confirm the condition of the cell phone.
FAILED	CONNECTION ERROR/ERROR	When registering: Check whether the cell phone is Bluetooth-compatible When connecting: Check whether the cell phone has been registered in the main unit.
MEMORY FULL	NO MEMORY SPACE	Delete the phonebook data of the main unit, and then perform the registration again.

When you think there is a malfunction

A slight difference in operation may be mistaken for a malfunction. Please check the items in the following table first.

If the unit does not work, even after the appropriate remedial action has been taken, please contact your dealer.

Mode	Problems	Causes	Remedial action	Refer to page
All	The sound is difficult to hear or cannot be heard at all.	Is the volume sufficient?	Turn up the volume.	18
		Is the muting function activated (MUTE)?	Cancel the muting (MUTE) function.	18
		Is the fader or balance control set to one side?	Readjust the fader and balance controls to normal positions.	64
		Other probable causes include broken or pinched audio-signal wires, a faulty speaker, or a detached connector.	Have your dealer check the problem.	—
	Power does not come on.	Are there too many electrical items installed, causing a lack of available power?	Have your dealer check the problem.	—
		Other probable causes include a run-down car battery, a blown fuse, or pinched or broken power or communication wires.	Have your dealer check the problem.	—
	Frequencies or titles set in memory have been deleted.	Has the car battery been disconnected for repairs or inspections?	Reenter the frequencies or titles into memory.	43
		Are there too many electrical items installed, causing a lack of available power?	Have your dealer check the problem.	—
		Other probable causes include a run-down car battery, a blown fuse, or pinched or broken power or communication wires.	Have your dealer check the problem.	—
	There is no guide tone.	Is the guide tone set to OFF?	Reset the guide tone to ON.	77
	The remote control does not work.	Are the batteries low?	Replace the batteries.	47
		Are the batteries installed correctly? (reversed polarity)	Reinstall the batteries correctly. (correct polarity)	47
		Is direct sunlight hitting the remote control light receptor?	Use the remote control in closer proximity to the receptor.	—
		There may be a malfunction in the remote control unit.	Have your dealer check the problem.	—

Mode	Problems	Causes	Remedial action	Refer to page
CD	The disc cannot be inserted. The disc is ejected as soon as it is inserted. The disc cannot be ejected. The disc cannot be changed.	Has an extra label or sticker been applied to the disc?	Do not apply labels or stickers to the disc.	22
		Are there rough edges, deformations or damaged areas on the disc?	Try inserting another disc. Remove any burrs. Do not use deformed or damaged discs.	22
	The sound skips. The sound is intermittent. The sound quality is poor.	Is the disc damaged?	Try another disc. Do not play damaged discs.	22
		Is the disc clean?	Clean the disc.	23
		Is the player mounted at a proper angle? Is the player mounted loosely?	Have your dealer check the problem.	—
		Are you driving over a rough surface?	Avoid playback while driving over rough surfaces.	14
	The disc cannot be ejected.	If unknown	Press the [▲] (OPEN/EJECT) button for longer than five seconds with the front panel opened.	—
	Tuner	No stations can be received. Static noise is received.	Is the antenna retracted?	Extend the antenna.
Is the tuner correctly tuned to a station?			Tune to a station.	42
Are you driving outside the service area of your preset stations?			Tune to a local station. (Please note, there may be no local stations servicing the area where you are currently driving.)	42
Are you operating other units, such as a computer or a mobile phone, in your vehicle at the same time as your main unit?			Avoid operating other units while using the main unit.	—
Other probable causes include deterioration of the antenna or broken antenna wires.			Have your authorized Eclipse dealer check the problem.	—

Specifications

<GENERAL>

Power Supply	14.4V DC (11-16V)
Current Drain	3A
Dimensions (W x H x D)	
In-Dash Main unit	7" x 2" x 6-1/8" (178 x 50 x 155mm)
Mass (weight)	Approx. 1.7kg
Usage temperature range	-20°C to +65°C (-4°F to +149°F)
Storage temperature range	-40°C to +85°C (-20°F to +185°F)

<FM TUNER>

Frequency Range	
USA:	87.75 to 107.9MHz (0.2MHz step)
Asia:	87.5 to 108MHz (0.05MHz step)
Australia:	87.5 to 108MHz (0.1MHz step)
Latin America:	87.75 to 107.9MHz (0.1MHz step)
Usable Sensitivity	15dBf
50dB Quieting Sensitivity	24dBf
Frequency Response	30 to 15,000Hz,± 3dB
Stereo Separation	38dB (1kHz)

<AM TUNER>

Frequency Range	
USA:	530 to 1,710kHz (10kHz step)
Asia:	522 to 1,629kHz (9kHz step)
Australia:	522 to 1,710kHz (9kHz step)
Latin America:	530 to 1,710kHz (10kHz step)
Usable Sensitivity	22µV

<CD SECTION>

Frequency Response	20Hz to 20kHz, ±3dB
Wow & Flutter	Below measurable limits
Stereo Separation	80dB
S/N Ratio (A-weighted)	95dB
Dynamic Range	95dB
Total Harmonic Distortion	0.008%

<USB MEMORY SECTION>

Frequency Response	20Hz to 20kHz, ±3dB
S/N Ratio (A-weighted)	95dB
Total Harmonic Distortion	0.008 %

<Bluetooth Audio>

Bluetooth Specification
Output
Profile

Bluetooth Specification Ver.2.0
Power class 2 (Max +4dBm)
A2DP Ver.1.0
AVRCP Ver.1.0

<Bluetooth Handsfree>

Bluetooth Specification
Output
Profile

Bluetooth Specification Ver.2.0
Power class 2 (Max +4dBm)
HFP Ver.1.5
OPP Ver.1.1

<AUDIO AMPLIFIER>

Power Output

14W x 4 (20Hz to 20kHz, 1% THD, 4Ω,
Vcc=14.4V)

Output Level/Impedance
Loudness

Maximum of 50W x 4
5V/55Ω line-out impedance
+10dB at 100Hz/+6dB at 10kHz

How to contact customer service

Should the product require service, please contact the following Eclipse dealer near your house.

<U.S.A/CANADA>

Fujitsu Ten Corp. of America
19600 South Vermont Avenue, Torrance, CA 90502
Phone: 1-800-233-2216 (Information)

<AUSTRALIA>

Fujitsu Ten (Australia) PTY LTD.
89 Cook Street Port Melbourne, Victoria 3207 Australia
Phone: 1800 211 411
Fax: 03 9646 8084

<MALAYSIA>

CSE Automotive Technologies Sdn. Bhd.
Level 5, Axis Plaza, Jalan U1/44, Glenmarie, 40150 Shah Alam,
Selangor D.E., Malaysia
Phone: 03-5569-4200
Fax: 03-5569-4201

<SINGAPORE>

Cobara Singapore Pte Ltd
#07-02 King's Centre 390, Havelock Road Singapore 169662
Phone: 6737 2568
Fax : 6737 9538

<KOREA>

J & TED TRADE
Toy Bldg 2F, 1815 San Kyuk 2 Dong, Buk Gu, Daegu, Korea
Phone: (053) 382-8248
Fax: (053) 382-8249

<TAIWAN>

Sentrek Taiwan, LTD.
1, 9F, Lane 155, Section 3, Peishen RD., Shenkeng, Taipei Hsien, 222
Taiwan, R.O.C.
Phone: 02-2662-8110
Fax: 02-2662-8117

<INDONESIA>

PT. Anugrah Valova Electrindo.
Jl.Bukit Gading Raya Blok P 21-22, Kelepa Gading Barat, Jakarta 14240
Phone: (021) 4585-2857
Fax: (021) 4586-5710

<THAILAND>

Safe-T-Cut (Thailand) Co., Ltd.
114/9 Soi Suwansawadi, Thungmahamek, Rama 4 Rd., Sathorn,
Bangkok 10120, Thailand.
Phone: 02-671-9610-12
Fax: 02-671-9614

IMPORTANT

**RECORD YOUR “KEY CD
(SECURITY CODE)”
HERE...**

**STORE YOUR “KEY CD
(SECURITY CODE)” ALONG
WITH YOUR OWNER'S
MANUAL.**

