



OWNER'S MANUAL



AVN726E

DVD-Video / USB Multi-Source Receiver /
7" Wide Screen Monitor / Navigation /
Built-in Bluetooth® wireless technology



We appreciate your purchase of this main unit.
Please read through this manual for correct operation.
We suggest that after reading it you keep this manual
in a safe place for future reference.

The symbols described below are found in this instruction manual as well as on the device itself to insure its proper and safe usage and to prevent injury or damage to property. Make sure you understand the meaning of these symbols before reading the rest of this manual.

Precautions for Use

The following symbols will precede information useful for preventing damage to the main unit as well as for its smooth operation.

WARNING

This sign indicates a situation in which incorrect handling through disregard of a sign might result in death or serious personal injury.

CAUTION

This sign indicates a situation in which incorrect handling through disregard of a sign might result in personal injury or may result solely in damage to property.

IMPORTANT

Follow this advice to prevent malfunctions or damage to the main unit. Perform the indicated action in the event of a malfunction.

ATTENTION

Useful information for the smooth operation of the main unit.

CHECK

Facts to keep in mind when operating the main unit.

- Please read all materials such as manuals and warranties that have come with the product. ECLIPSE will not be responsible for unsatisfactory product performance due to failure to follow these instructions.
- Changes to product specifications may result in differences between content of the manual and features of the product.

CAUTION

There is the possibility that the touch switches of the display screen may not operate correctly if condensation forms inside them. In such a case, do not attempt to operate them until the condensation has disappeared.

Before Use

1. Safety precautions.....	14
2. Viewing this Document.	18
3. About This Receiver	19
Control Names and Operations.....	19
Panel buttons	19
Touch switch	20
About touch switch operations	20
Turning the POWER ON or OFF	21
Turn on the power	21
Turn off the audio	21
Loading/Unloading a Disc	22
Loading a disc	22
Unloading a disc	23
Adjusting the Display Angle.....	24
About “SD memory card” slot.....	25
About Modes of this Receiver	26
Starting each Mode	27
Navigation screen.....	27
Audio operations screen.....	27
About screen display	27
Operation Conditions of this Receiver	28
4. Main Unit Settings	29
Camera Setting	29
Guide Tone Setting.....	30
Color Pattern Setting.....	30
Button Illumination Setting.....	31
Navi Voice Output Setting	32
VTR Input Setting	32
Screen Adjustment and Setting	33
Picture quality adjustment screen display	33
Switching between night picture and day picture.	34
Hiding screens.....	34
Picture quality adjustment	34

Brightness	34
Color balance (only applies to Video screen).....	34
Color density (only applies to Video screen).....	34
ESN (Eclipse Security Network) Setting	35
ESN setting screen display	35
Operation of ESN security.....	36
Unlocking ESN security lock	36
Cancelling ESN security.....	37
Setting display of security indicator.....	37

5. Bluetooth Hands-Free Operation 38

Using Bluetooth Hands-Free	38
Hands-free screen display.....	38
Registering a cell phone.....	38
Registering from a cell phone	39
Register by searching for cell phone on this receiver	39
Deleting cell phone registration.....	40
Connecting a cell phone.....	41
Cancelling a cell phone connection.....	41
Making a call	42
Entering the telephone number to make the call.	42
Calling from call history.....	42
Calling from the telephone book	43
Receiving a call	44
Ending a call (call refusal).....	44
Adjusting the ringtone volume.....	44
Adjusting the talking volume.....	44
Hands-free settings	45
Auto Answer settings	45
Ringtone settings	45
Auto Connect settings	45
PIN Code setting	45

Starting Out

1. About GPS Navigation	46
Before Using the GPS Navigation.....	46
Simple mode and Advanced mode	46
Viewing Navigation Screen	46
Screen switches and other operations	46

Operation

1. Navigation Overview	48
Navigation Menu.....	48
Navigation Details Setting Screen	48
Settings menu	48
Quick Menu	50
Route menu.....	51
Management menu	51
User data management.....	52
Map screen settings	52
Route planning option	53
Road Types Used for Route Planning:.....	54
Route calculation methods:.....	54
Navigation settings.....	55
Regional settings.....	55
Time and Time Zone Settings	56
Warning settings.....	56
Menu settings.....	57
Track log settings	57
TMC settings	58
Safety Mode settings	58
Trip information screen.....	58
Trip computer screen	60
Screen Adjustment and Setting	61
Day screen and night screen	61
Screen color in tunnels.....	61
Volume settings	61
Map Display.....	62
Present location display	62
Cursor menu.....	63
Position menu.....	65
Checking vicinity information.....	65
Map menu operations.....	66
Map screen status information and hiding operation	68
Using the Cursor (at selected position)	72
Present location and route tracking	73
Returning to normal Map screen	73
Position determination (Cursor)	74
Displaying original position in cursor menu	74

Switching to desired scale	74
Enabling smart zoom	75
Fine-tuning Smart Zoom	75
Driving track display	75
Using logs	75
Recording the travelled path (creating a Track Log)	76
Simulating a Track Log on the map	76
Changing the color of a Track Log	77
Saving route	77
Loading saved route	78
Map screen	78
About roads	82
3D Object types	82
Managing facilities information	82
Itinerary display	84
Route editing	85
Route information screen	85
Facility information, storage, and revision	87
Saving POIs	87
Managing POIs	87
Managing saved search criteria	87
Using Keyboard Screen	88

Navigation Guidance

1. Navigation Guidance	89
Destination Setting	89
Setting from Map Scroll	89
Setting from Address	90
Entering Address	90
Entering addresses for repeating house number allocation	91
Entering address without knowing district or suburb	92
Selecting from intersection	93
Selecting from city center	94
Selecting from ZIP code	95
Entering quick address	96
Setting from Favorites	96
Setting from Facility Information	96
Selecting from facility information	96
Select from saved facility information search criteria	98

Setting from History	98
Setting from Coordinates	98
Search Menu	99
Display route (in accordance with screen)	99
Traffic	99
Route Search and Advanced Search	100
Creating multiple destinations (adding intermediate points)	100
Creating multiple destinations (adding new destination)	101
Deleting an intermediate point from the route	102
Detour menu.....	102
About Destination History	102
Managing history	102
Deleting Destination History	102
Deleting active route	102
Managing saved routes	103
Managing Track Logs	103
Demonstration (Demo)	104
Viewing a route demonstration	104
2. Storing Locations	105
Managing Favorites	105
3. What to Do When...	106
About GPS Satellite Quality and Status	106
About Speed Warnings	107
About Road Safety Cameras	107
Saving road safety cameras	107
Camera warning	108
Road Safety Camera types	108
Road Safety Camera directions	109

Optional Features

1. Rear View Camera Operations	110
Imaging with the Rear View Camera	111
When camera is set to AUTO	111
When camera is set to MANUAL	111

What to Do When...

1. Display of Connection Status Information	113
Display of Connection Status Information	113
2. Accuracy and Error	114
About measurement accuracy	114
About GPS Satellite Quality and Status	114
About Errors in Present Location Display	115
About Correction of Vehicle Position Detection by Map Matching	115
About Accuracy of Present Position Display and Route Guidance	115
About Road and Place-Name Data.....	117
About Route Guidance	117

Starting Out

1. Before Use.....	119
About Discs.....	121

Operation

1. Switching Audio Source	124
Switching the Audio Source.....	124
Display of Audio Operations Screen	124
Stopping audio mode.....	124
2. Source Operations Screen.....	125
3. Volume Control	127
Main Volume Control.....	127
4. Adjusting sound quality.....	128
Display of Audio Settings Screen	128
Adjusting audio balance	128
Sub-Woofers Settings	129
Setting sub-woofer level.....	129
Switching the phase	129

Setting low pass filter	130
Setting Loudness	130
Setting Source Volume Control	131
Adjusting Sound Quality.....	132
Adjusting sound quality	132
Storing sound quality.....	132
Use a preset sound quality.....	133
5. Screen Settings.....	134
Switching Between Screen Modes	134

Other operations

1. About Remote Control	135
Remote Control Operations.....	135
Precautions for use	135
About cleaning.....	135
Remote control.....	135
Exchanging Batteries.....	136

Audio Operations

1. Using Radio.....	137
Using Radio	137
Listening to Radio	137
Tune a Desired Station.....	137
Manual Tuning.....	137
Auto Tuning.....	138
Selecting from preset switch	138
Selecting Radio Band.....	138
Saving Station in Memory.....	139
Manual saving	139
Automatic saving.....	139
2. Using HD Radio	140
Using HD Radio	140
Listening to Radio	140

Select Desired Station.....	141
Manual Tuning.....	141
Auto Tuning.....	141
Selecting from preset switch	141
Selecting a Radio Band.....	141
Saving Station in Memory.....	142
Manual Saving.....	142
Automatic saving.....	142
Displaying title information	143
Obtaining Tag Information	143
Receiving Sub-channel Broadcasts	144
3. How to Use SIRIUS Satellite Radio	145
Using SIRIUS satellite radio	145
Listening to SIRIUS Satellite Radio	145
Checking SIRIUS ID.....	146
Changing SIRIUS Band.....	146
Selecting Channel to Listen to.....	146
Selecting from category.....	146
Manually selecting channel	147
Automatically selecting channel	147
Selecting a channel by entering it directly.	147
Saving Channels.....	148
Selecting Preset Channel	148
Displaying Information about Current Broadcast	149
4. How to Use XM Satellite Radio	150
Using XM Satellite Radio	150
Listening to XM satellite radio.....	150
Checking RADIO ID	151
Changing XM Band	151
Selecting Channel to Listen to.....	151
Selecting from category.....	151
Manually selecting channel	152
Automatically selecting channel	152
Selecting a channel by entering it directly.	152
Saving Channels.....	153

Selecting Preset Channel	153
Displaying Information about Current Broadcast	153
5. Using CD Player	155
Using CD Player.....	155
Listening to CD	155
Selecting Track to Listen to.....	155
Fast Forwarding/Rewinding	156
Finding Desired Track.....	156
Repeating Same Track.....	156
Random Play.....	156
6. Using MP3/WMA Player	157
Using MP3/WMA Player	157
Playing MP3/WMA File	157
Selecting desired folder.....	158
Selecting from folder list.....	158
Select from linked folders	159
Selecting Desired Music File	159
Selecting from file name switch.....	159
Select from linked files	160
Fast Forward/Rewind	160
Finding Desired Music File.....	160
Repeating Music File.....	161
Random Play.....	161
About MP3/WMA.....	162
About supported MP3 file standards	162
About supported WMA file standards	162
About ID3/WMA tags.....	163
About supported media types.....	163
About format of discs.....	163
About file names.....	164
Multi-sessions.....	165
About playing MP3/WMA	165
About MP3/WMA playing time display	165
Creating and Playing MP3/WMA Files	165
Downloading from MP3/WMA music sites on the Internet	165

Converting music CD into MP3/WMA files	166
Writing MP3/WMA files on CD-R/RW disc	166
Playing back CD-R/RW	166
7. Using USB Music File Player	167
Using USB Music File Player	167
Playing USB Music Files	167
Selecting Desired Folder	168
Selecting from folder list	168
Select from linked folders	168
Selecting Desired Music File	169
Selecting from file name switch	169
Select from linked files	169
Fast Forward/Rewind	170
Finding Desired Music File	170
Repeating Music File	170
Random Play of Music Files	171
About USB Devices	171
About supported USB memory standards	171
Supported MP3 file standards	171
ID3 tags	171
Format of USB memory	172

Visual operations

1. Before Using the DVD Player	173
Advantages of Digital Versatile Disc (DVD)	173
Multi-Audio Function	173
Multi-Angle Function	173
Subtitle Display Function	173
Discs	174
Types of Playable Discs	174
Region Code of Playable Disc	174
Mark Indicated on Disc	175
Disc Configuration	175
Products equipped with Macrovision	176
Operation Flow	176

2. Using the DVD Player	177
Using the DVD Player.....	177
Watching a DVD Video	177
Video Operations.....	178
Playing a Video	178
Fast Forward/Rewind	178
Fast Forwarding or Rewinding Using Panel Switch	178
Fast Forwarding or Rewinding Using Touch Switches.....	178
Pausing a Video	178
Stopping a Video	179
Disc Menu Operations.....	179
Finding a Desired Video.....	179
Finding by Chapter.....	179
Finding by Title Number	180
Finding by chapter number.....	180
Changing the Touch Switch Display	181
Hiding the Touch Switch.....	181
Relocating the Touch Switch Display	181
Changing the Screen Display and Audio Mode.....	182
Changing the Angle.....	182
Changing the Subtitle Language.....	182
Changing the Audio Language.....	183
Switching DVD setting display.....	184
DVD Player Setting	185
Specifying the Audio Language.....	186
Entering the Code	186
Specifying the Subtitle Language.....	187
Entering the Code	187
Specifying the Menu Language.....	188
Entering the Code	188
Setting display of multi-angle mark	189
Specifying the Parental Screening Level.....	189
Switching the Video Output.....	190
Language Code List	191
3. Using the VTR	192
Using the VTR.....	192
Playing the VTR	192
Changing the VTR Setting Screen	193

4. Using the DivX Player.....	194
Using the DivX Player	194
Playing the DivX	195
Video Operations.....	195
Fast Forward/Rewind	195
Pausing a Video	195
Select the folder to view	196
Select from the folder list.....	196
Select from continuous folder.....	196
Select the file to view	196
Select from file name switch.....	196
Select from linked files	197
Fast Forward/Rewind	197
Repeating a video file.....	197
Random Play.....	198
Changing the Subtitle Language	198
Changing the Audio Language	199
Display DivX VOD code.....	200
Caution display while playing VOD Rental file	201
Switching the Video Output.....	201
About DivX	202
About the DivX standards that can be played back.....	202

How to operate portable audio devices

1. Using the iPod® Player.....	203
Using the iPod Player.....	203
Listening to the iPod	203
Fast Forward/Rewind	204
Selecting the Desired Music or Video File	204
Finding a Desired Music File	204
View the list of playing back.....	205
Setting to the iPod Video Mode.....	206
Select the video file to view from the list	206
Pausing.....	207

Repeatedly Playing the Same Music File	207
Random Play of Music Files	208
Listen randomly from the list that is playing	208
Listen to an album randomly	208
Listen all music files random	209

2. Using Bluetooth Audio 210

Using Bluetooth Audio.....	210
Registration of portable devices	210
Registration from the portable device	210
Register by searching for a portable device on this receiver	211
Connection of the portable device.....	212
Cancelling a portable device connection.....	213
Listening to the portable device.....	213
Stop the playback.....	214
Selecting a Desired Music.....	214
Fast forward / rewind.....	214
Repeating the Same Track.....	214
Random Play.....	215

Others

1. About the Steering Wheel Switches	216
Manual setting of steering wheel switch functions.....	216
Compatibility with Steering Wheel Switches	218

Reference

1. Necessary Information	220
If the Following Messages Appear.....	220
When You Think There Is a Malfunction	224
2. Glossary	226
3. Specifications	227

Safety precautions

WARNING

- Do not modify this system for any uses other than that specified herein. Also, do not deviate from the installation procedures described herein. Eclipse will not be held liable for damages including, but not limited to serious injury, death or property damage resulting from installations that enable unintended operation.
- The main unit requires a 12V DC power supply. The main unit should not be installed in any vehicle which does not have a 12 V power system with a ground-connected negative side. An installation other than the one intended may cause severe damage to the main unit, electric shock or personal injury.
- Never install the main unit where it will interfere with safe operation of the vehicle.
- Never block the drivers' view. Do not install the main unit where it may interfere with operation of the brakes, the steering or safety systems, such as seat belts and air bags.
- Before drilling holes in a vehicle for installation, be sure to confirm the locations of pipes, tanks, electrical wiring, and other vehicle systems and components to ensure that there will be no interference or contact. In addition, apply rust prevention and leak prevention measures at the drilling area. Otherwise, fire or electric shock could occur.
- When installing the main unit, do not remove or alter existing vehicle fasteners, including nuts, bolts, screws, clips, and fittings. Never detach, move or alter existing vehicle wiring, including electrical grounds and straps. Alteration of existing vehicle components may make vehicle unsafe to operate.
- Before installation, remove the negative (-) battery terminal to prevent shocks, electrical arcing, fires, and damage to vehicle wiring and the main unit you are installing.
- Secure wiring with non-conductive tape or plastic ties so that wires do not interfere with vehicle operation, including the brake pedal, gear shifter and steering. Position wires so that they will not be rubbed, abraded, or damaged by moving vehicle components, including power seats.
- To avoid damage to the main unit and vehicle, including fire, never supply power to an installed main unit in a way that will overload the capacity of an existing vehicle circuit. Never leave a power supply wire or connection uninsulated. Always install supplied fuses, circuit breakers, and relays.
- Air bags are a vital part of a safety system. Never install main unit in a way which will alter air bag wiring or interfere with air bag deployment. Air bags must function properly in the event of an accident.
- When installation is complete, test all vehicle electrical systems to ensure they operate correctly, including lights, horn, brake lights, and emergency flashers.
- For your protection, never use a power drill without wearing safety glasses or goggles. Debris or broken drill bits may cause severe eye injuries, including blindness.
- Use electrical tape to insulate the ends of all wires, even if they are not used. Proper insulation prevents arcs, shocks and fires.
- Some devices require the use of batteries. Never install main unit where young children can get access to batteries. If a battery is swallowed, seek immediate medical attention.
- When the vehicle is in motion, never take your eyes off the road to make adjustments to the main unit. To prevent accidents, keep your eyes on the road. Do not lose concentration on your driving when operating or making adjustments to the main unit.
- The driver should not look at the screen while driving. Doing so may result in an accident.

- Do not place foreign objects in the disc insertion slot or iPod/USB input terminal. Fire or shocks may result.
- Do not disassemble or alter this main unit. Doing so may result in an accident, fire or shock.
- Do not let water or foreign objects enter the internal parts of this main unit. Doing so may result in smoke, fire or shock.
- Do not use when main unit is malfunctioning (the screen is not lit or no sound comes out). Doing so may result in an accident, fire or shock.
- Always replace fuses with fuses of identical capacity and characteristics. Never use a fuse with a higher capacity than the original fuse. Using the wrong type of fuse may cause a fire or severe damage.
- If foreign objects or water enters the main unit, smoke or a strange odor may be emitted. If this occurs, stop using the main unit immediately and contact your dealer. Accidents, fire, or shocks may result if you continue to use the main unit under these conditions.
- The driver should not change the Disc or iPod/USB memory while driving. Doing so may result in an accident. You must first stop or park your car in a safe location and then proceed to remove or insert the Disc and/or iPod/USB.
- Plastic bags and wrappings may cause suffocation and death. Keep these objects away from babies and children. Never place bags or wrappings over anyone's head or mouth.
- Be sure to park the vehicle in a safe location and set the parking brake before watching DVDs or videos. For safety reasons, only the sound of DVDs or videos will be emitted while the vehicle is in motion.

Safety precautions

CAUTION

- Wiring and installing this main unit requires expertise and experience. Professional installation is recommended. Consult with your dealer or a professional installation expert. Incorrect wiring may damage the main unit or interfere with safe operation of the vehicle.
- Use only specified accessory parts. Using other parts may cause damage to the main unit or cause parts to dislodge and fall or fly off the main unit.
- Do not install the main unit in places where it may be exposed to dew condensation (around the air conditioning hose, etc.), or in locations where it may come in contact with water, high levels of moisture, dust or oily smoke. If water, moisture, dust or oily smoke enters this main unit, smoke, fires or malfunctions may result.
- Do not install in places subject to direct sunlight or where it may be hit directly by hot air from the heater. This may increase the interior temperature of the main unit, resulting in fires and malfunctions.
- Do not impede the air flow of the heat sink or vents of this main unit. Impeding the air flow will cause the interior of the main unit to overheat, and fires may result.
- Connect as specified in the installation manual. If not connected correctly, fires or accidents may result.
- Install wiring in a manner in which cables will not be pinched by movable parts such as seat rails, and screw parts of the vehicle body. Accidents, fires and shocks may result from disconnection and electrical shorts.
- Install wiring in a manner in which cables will not come in contact with metal parts. The wiring may be damaged by contact with metal parts, resulting in fire and shocks.
- Avoid all contact with hot surfaces when wiring the main unit. High temperatures may damage wiring, causing shorts, arcing and fires.
- When changing the installation location for this main unit, please consult the dealer where you bought it for safety reasons. Expertise is necessary for removal and installation.
- Keep volume to a reasonable level so that you can hear sounds from outside the vehicle, including warning sounds, voices, and sirens. Failure to do so may cause an accident.
- Be careful that your hands and fingers do not get pinched when adjusting the tilting angle or closing the display. Injuries may result.
- Do not put your hands or fingers into the disc insertion slot or iPod/USB input terminal. Injuries may result.
- Do not touch hot parts of the main unit. Fire may result.
- The volume should be set at a moderate level to avoid hearing damage when the main unit is powered on.
- Do not operate when sound such as distortion is being emitted.
- The main unit uses invisible laser light. Do not disassemble or alter this main unit. If any problems occur, contact the dealer where you purchased the main unit. Altering this main unit may cause exposure to laser emissions (which may damage your eyesight), or result in an accident, fire or shocks.
- If the main unit is dropped or the front panel is damaged, turn off the power to the main unit and contact your dealer. If used in this condition, fires or shocks may result.

IMPORTANT

- When there is a lot of vibration – when driving on a bad road for example – the main unit may become inoperable due to it not being able to read data from the disc.
 - In cold temperatures, condensation may accumulate on the lens for readings CDs and DVDs immediately after turning ON the heater. Wait approximately 1 hour for the condensation to evaporate and the device will operate normally.
Contact the store where you purchased the device if normal operation does not resume after several hours.
 - If using this receiver immediately after having purchased it or after having stored it disconnected from the vehicle battery, the present location may not be displayed accurately. Wait a short while and the GPS positioning will correct the displayed position.
 - This device is precision-engineered equipment and the information that you record on it after purchase can be lost as a result of static electricity, electrical noise, vibration and other influences. It is recommended that you keep a separate record of the information you store in the main unit.
 - Note that the following events are not covered by the warranty.
 - ① Corruption or loss of the data stored in the main unit by the purchaser resulting from failure or incorrect operation of the main unit, or any problems associated with it, or due to the effects of electrical noise or other influences.
 - ② Corruption or loss of the data stored in the main unit by the purchaser resulting from misuse of the main unit by the purchaser or a third party.
 - ③ Corruption or loss of data stored in the main unit by the purchaser resulting from failure/repair of the main unit.
- * Please note that by installing or using the main unit, you are regarded as having consented to the points above.

Viewing this Document.

Section title

A title is assigned for each section.

Item title

A number and title is assigned for each item.

Operation title

A title is assigned for each operation .

Detailed operation title

A title is assigned for each detailed operation.

Operation procedure

Describes the operation. Proceed with the operation as per the numerical order.

Operation screen

A screen showing the operation will appear.

• How to operate portable audio devices

Using Bluetooth Audio

Using Bluetooth Audio

A Bluetooth compatible portable audio player ("portable device" hereafter) can be used as a source for this unit by utilizing the Bluetooth wireless communication technology.

To use a Bluetooth compatible portable device with this unit, it is necessary to perform Bluetooth registration and connection settings.

- The Bluetooth compatible portable device to be connected must be a portable device which supports the relevant Bluetooth specification. For the Bluetooth specification supported by this receiver, see Specification. (See page 219)

- Bluetooth is a short-range wireless technology for connecting cell phones, computers and other such devices.



Bluetooth® is a registered trademark of Bluetooth SIG, Inc.

ATTENTION

- This unit can be used with Bluetooth compatible portable devices.
- See the operation manual of the portable device regarding the operation of Bluetooth.
- The connection status may become bad and operation with this unit may not be possible for the Bluetooth audio depending on the

Registration of portable devices

Register a portable device to this receiver. Portable devices can be registered in two ways, from the portable device, or by searching for the portable device on this receiver. Only one portable device can be registered to this unit.

IMPORTANT

Do not perform registration operation of the portable device while driving. Perform the registration operation after stopping the vehicle in a safe location.

Registration from the portable device

1 Press **MENU**.

2 Touch **Bluetooth Audio**.



3 Touch **Pairing**.



CHECK

In this document, the main unit is generally described using the screens which appear when the optional devices are connected.

Navigation is mostly described using the North - upwards 1 screen.

About switch display.

When a panel button is to be pressed, button names are shown as **NAVI** (**AV** , **▲** , etc.).

When a touch switch is to be touched, switch names are shown as **○○○** or **[○○○]**.

About This Receiver

Control Names and Operations

You can operate this receiver by pressing the buttons (panel buttons) or by touching the switches displayed on the screen (touch switches).

■ Panel buttons

Press each panel button to operate it.

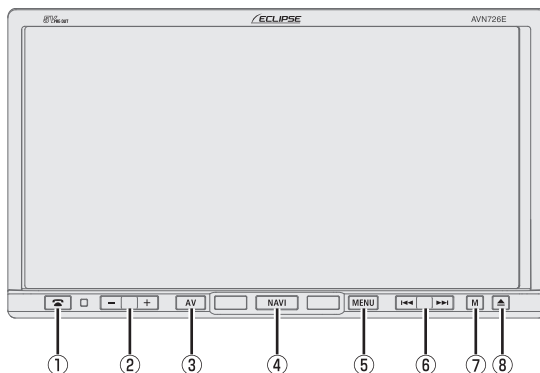

①	Phone button	Press to make a telephone call.
②	VOL button	Press to adjust volume of audio.
③	AV button	Press to display the audio operation screens. Press to adjust the screen image quality or screen brightness. (Press for 1 second or more)
④	NAVI button	Press to display the navigation menu screen.
⑤	MENU button	Press to display the (audio/info) menu screen.
⑥	TUNE/TRACK button	For radio mode: Press to select station manually. Press to select station automatically. (Press for 1 second or more) For CD, MP3/WMA, USB, and iPod mode: Press to select a track or music file. Press to fast forward or fast reverse track or music file. (Press for 1 second or more) For DVD, DivX, and iPod-video mode: Press to select videos or chapters. Press to fast forward or fast reverse videos and chapters. (Press for 1 second or more)
⑦	MUTE button	Press to mute sound.
⑧	OPEN/TILT button	Press to open display or adjust angle of screen.

About This Receiver

■ Touch switch

Touch the switches on the screen to operate.

⚠ IMPORTANT

Touch the touch switches with your finger.

Operating touch switches with the point of hard objects such as ballpoint pens or mechanical pencils can damage screen.

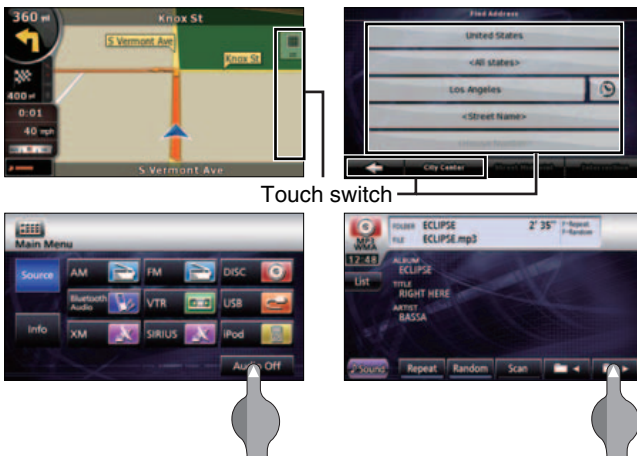

About touch switch operations

- Keep touching the touch switch until “beep” is emitted in response. (When guide tone is set to ON.)
- To protect the screen, touch the touch switch lightly with your finger.
- When there is no response from switch, remove your finger from the screen and touch again.
- Disabled touch switches have their color toned down.
- When the switch function is enabled, the switches return to brighter colors.

Turning the POWER ON or OFF

At ignition, this receiver automatically switches on and displays the Navigation screen*. When the engine is switched off, this receiver switches off.

* The Navigation screen displays your present location. The Audio operations screen displays screen of audio source that was playing on last use.

■ Turn on the power

The Caution screen is displayed automatically. After selecting a language, touch [I Agree] to display the Navigation screen.

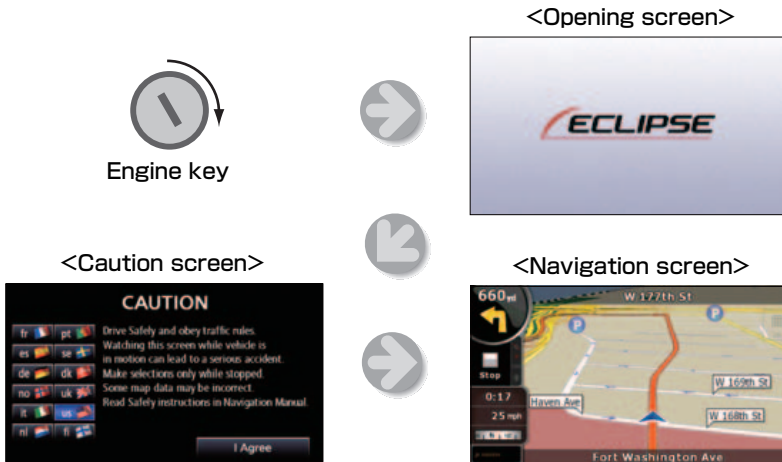

■ Turn off the audio

- Touch **Audio Off** on the Menu screen
(If you are on the Navigation screen, switch to the Menu screen to do this.)

📖 ATTENTION

- To turn off the audio power when the Navigation screen is displayed, first switch to the Source screen,
- When the audio power is turned off, touch the source you wish to change to on the Source screen. For details, see “Switching the Audio Source” on page 124.
- You cannot turn off the navigation power.

About This Receiver

Loading/Unloading a Disc

When you listen to music, insert a CD into the drive slot. Also, when you play a movie, insert its DVD into the slot.

■ Loading a disc

⚠ IMPORTANT

This receiver can play 8cm CDs and 8cm DVDs. To avoid disc problems, insert a disc without using an adapter.

⚠ CAUTION

- You may not be able to open or close the display when the gearshift lever is set to P in an automatic transmission car or 1/3/5 or Ⓒ in a manual transmission car; or when a bottle or a similar object is placed in the cup holder. To open or close the display safely, set the gearshift lever to N (automatic transmission car) or to the Neutral position (manual transmission car) in advance, or empty the cup holder. Make sure that the car is not in motion by applying the parking brake and appropriately stepping on the foot brake in order to prevent damage or injury.
- Do not place a cup or can on the display while the display is opened. Doing so may damage the display.
- When a disc is loaded, do not press **CLOSE** or .

1 Press .

2 Touch **DISC**.

- The display will open to reveal insertion slot.

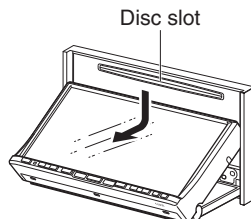

3 Insert a disc into the slot.

- The display will close automatically when the disc is inserted.
- Hold a DVD or CD correctly (by inserting your finger in its center hole and by holding the disc edge by another finger), face the disc label side upward, and insert the disc into the slot.
- When you insert a DVD into slot, its movie will be played in the DVD mode.
- When you insert a CD into slot, its music will be played or the MP3/WMA play will start.

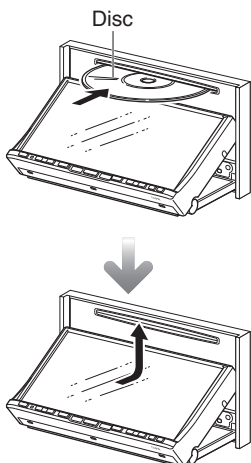

ATTENTION

Press  for a second or more to open the display.

■ Unloading a disc

IMPORTANT

- When unloading a disc, use the following notes.

Automatic transmission (AT) car:

If it is difficult to unload disc when the shift lever is in the P position, shift it to the N position. (If your car has a column shift lever, shift it to the P or N position.)

Manual transmission (MT) car:

If it is difficult to unload disc when the shift lever is in "1", "3", "5" or "R" position, shift it to the Neutral position.

- Take care NOT to close the display when the ejected disc remains in the slot. If this caution is not observed, this receiver or the disc may be scratched.
- Do not attempt to close the front panel by hand. Doing so may damage the display.
- Do not put cups, cans, or any other objects on the display when it is open. Doing so may damage the display.
- Wipe and clean the display immediately if juice or other liquid spills onto it. If it is not cleaned, the display may be damaged.
- To protect the display from heat and dust, keep the display closed except when you load or unload a disc.

About This Receiver

1 Press .

2 Touch **DISC**.

- The disc will be ejected automatically.



3 After removing the disc, touch **CLOSE**.

- Press  to close the display.

Adjusting the Display Angle

When the screen shines due to ambient sunlight, you can adjust the angle of the display.

CAUTION

When adjusting its angle, take care not to pinch your fingers. Otherwise you may hurt yourself or the display may fail.

IMPORTANT

- Do not load a disc when the display is tilted. If this caution is not observed, this receiver or the disc may be scratched.
- When adjusting the display angle, use the following notes.



Automatic transmission (AT) car:

Adjust the display angle so as not to get in the way when shifting the AT lever to any of the P, , or N positions. (If the lever shift is interfered with, do not tilt the display.)

Manual transmission (MT) car:

Adjust the display angle so as not to get in the way when shifting the MT lever to any of the 1/3/5 or  positions. (If the lever shift is interfered with, do not tilt the display.)

1 Press .

2 Touch  or  of the angle adjustment.

●  :

Each touch returns the display from the tilted state by 1 step (5°). (Maximum 7 steps, 35°)

●  :

Each touch tilts the display by 1 step (5°). (Maximum 7 steps, 35°)

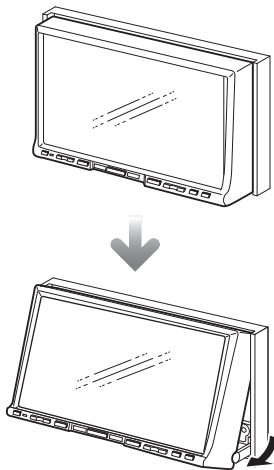

3 After adjusting the angle, press .

ATTENTION

- You can open the display even when it is tilted. When you close the display, it returns to the preset angle.
- If you tilt the display and turn the ignition key OFF, the display will return to the upright position. However, when you turn the ignition key to the ACC or ON position, the display returns to the preset angle.

About “SD memory card” slot

- “SD memory card” slot of this unit is used for map update.
- Once all our map update service are set, we will announce it on our homepage.

ATTENTION



SD Logo is a trademark.

About This Receiver

About Modes of this Receiver

The main modes of this receiver are **MENU**, **Navigation**, and **Audio**.



	Mode	Main functions
1	Navigation (press NAVI)	<ul style="list-style-type: none"> ● Display navigation menu screen ● Set destination, guidance
2	Audio (press AV)	<ul style="list-style-type: none"> ● Receive AM/FM radio ● Receive HD Radio ● Receive SIRIUS/XM satellite radio ● CD, MP3/WMA player operations ● Bluetooth audio player operations ● DVD/DivX player operations ● Display VTR video ● iPod operations ● Picture quality adjustment
3	Main menu (press MENU)	<ul style="list-style-type: none"> ● Displays audio menu Change audio source ● Displays information menu ESN setting Steering mode switch setting Rear View camera setting

* Some of these functions cannot be used when driving.

Starting each Mode

Press the following switches to switch among screens.

Navigation screen

Press **NAVI**.



Audio operations screen

Press **AV**.

(when operating as CD player)*1.



(OFF screen)*2



*1 Displayed when audio function is in operation. For audio operations, see "Switching the Audio Source" on page 124.

*2 Displayed when audio function is OFF.

About screen display

If DISC is loaded or USB or iPod is connected while the Navigation screen is displayed, the screendisplay will appear.

After a short time, the screen display disappears automatically.

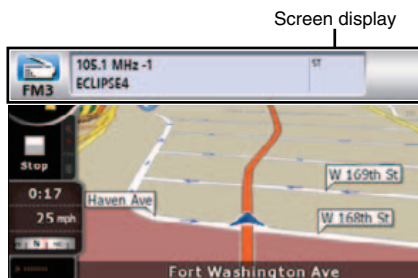

ATTENTION

When the iPod is disconnected, a screen corresponding to the audio source of the preceding mode is displayed.

About This Receiver

Operation Conditions of this Receiver

You can or cannot operate this receiver in the following conditions (the ignition key positions).

○: Operable; ×: Inoperable

Function	Engine switch				Display open
	Turns OFF	ACC	ON, vehicle at rest *1	ON, vehicle in motion	
Navigation/ settings and information	×	○	○	When the vehicle is in motion, some functions become inoperable for safety reasons*2.	×
Audio function	×	○	○	When the vehicle is in motion, some functions become inoperable for safety reasons.	×
Video function	×	○	○	When the vehicle is in motion, some functions become inoperable for safety reasons*3.	×
Loading and unloading of DISC and "SD memory card"/Display angle adjustment	After switching the engine OFF, the display can be closed.	○	○	○	Display angle cannot be adjusted

*1 When parking brake is on.

*2 When safety mode is set to on.

*3 Video not displayed.

ATTENTION

Disabled switches are toned down in color and inoperable. Operating an inoperable switch when the vehicle is in motion may result in the display of an operation prohibited message.

Main Unit Settings

Besides settings for navigation and audio operations, the following settings can be made.

- Rear View Camera Setting (See page 29)
- Guide Tone Setting (See page 30)
- Color Pattern Setting (See page 30)
- Button Illumination Setting (See page 31)
- Navi Voice Output Setting (See page 32)
- VTR Input Setting (See page 32)
- Steering Remote Setting (See page 216)
- Screen Adjustment and Setting (See page 33)
- ESN (Eclipse Security Network) Setting (See page 35)

Camera Setting

Set the camera to the AUTO or MANUAL operation mode.

AUTO is to switch to the camera picture when back gear is selected. MANUAL is to switch to camera picture when **Camera Screen** is touched.

1 Press **MENU**.

2 Touch **Info**.



3 Touch **Setting**.



4 Touch **Auto** or **Manual**.

- On completion, touch **Done** to store the setting and return to the immediately preceding screen.



Main Unit Settings

Guide Tone Setting

You can set the “beep” sound issued on pressing the panel buttons and touching the touch switches.

1 Press **MENU**.

2 Touch **Info**.



3 Touch **Setting**.



4 Touch either **On** or **Off** (mute) to set the guide tone.

- On completion, touch **Done** to store the setting and return to the immediately preceding screen.



ATTENTION

The guide tone is outputted from all speakers.

Color Pattern Setting

You can set the color pattern of the screens.

1 Press **MENU**.

2 Touch **Info**.



3 Touch **Setting**.



4 Touch **1**, **2**, **3**, **4**, or **5** to set the color pattern.

- On completion, touch **Done** to store the setting and return to the immediately preceding screen.



Button Illumination Setting

You can set the button illumination.

1 Press **MENU**.

2 Touch **Info**.



3 Touch **Setting**.



Main Unit Settings

4 Touch **Blue** or **Red**.

- On completion, touch **Done** to store the setting and return to the immediately preceding screen.



Navi Voice Output Setting

Select the Right or Left navigation voice channel.

1 Press **MENU**.

2 Touch **Info**.



3 Touch **Setting**.



4 Touch **Front L** or **Front R**.

- On completion, touch **Done** to store the setting and return to the immediately preceding screen.



VTR Input Setting

Set the video signal.

Auto automatically selects NTSC or PAL.

1 Press **MENU**.

2 Touch **Info**.



3 Touch **Setting**.



4 Touch **Auto**, **NTSC** or **PAL**.

- On completion, touch **Done** to store the setting and return to the immediately preceding screen.



Screen Adjustment and Setting

To make it easier to view the screen, switch between Day and Night based on whether the lights (sidelights, tail lights, license plate light) are on or off.

In some vehicles, this receiver may be unable to detect whether lights are on or off. In this is the case, manually switch between Day and Night.

Picture quality adjustment screen display

CHECK

The Picture quality adjustment screen can be opened from the Navigation screen, the Audio operations screen or the Video screen.

1 Press **AV** for at least 1 second.

2 On completion of the adjustment, touch **Done**.

- For adjustments, see "Picture quality adjustment" on page 34.
- When no operation is performed for around 20 seconds, this receiver selects a setting automatically and returns to the preceding screen.



- For the Navigation screen and Audio screen.

Main Unit Settings



- For the Video screen.

Switching between night picture and day picture.

1 When night picture is displayed, touch **Day**.

- On each touch, the display switches between the night picture and the day picture.

ATTENTION

When the power is switched on, the panel buttons are constantly lit.

Hiding screens

1 Touch **Off** on the Picture quality adjustment screen.

- To bring back the screen, press **NAVI** or **MENU**.

Picture quality adjustment

You can adjust the day picture and night picture independently.



- For the Navigation screen and Audio screen.



- For the Video screen.

Brightness

1 To increase brightness, touch **+**.
To decrease, touch **-**.

- The initial setting for when the lights are switched off is the maximum value (brightest state).

Color balance (only applies to Video screen)

1 To strengthen green, touch **G**. To strengthen red, touch **R**.

Color density (only applies to Video screen)

1 To darken color touch **+**. To lighten, touch **-**.

ESN (Eclipse Security Network) Setting

This receiver has a built-in ESN (ECLIPSE Security Network) function. ESN is a security system which renders the navigation and audio functions inoperable when the battery terminal is disconnected and reconnected.

You can make the security indicator flash when the security system is in operation.



INDICATOR

To operate ESN, register a music CD as a key CD in this receiver.

CHECK

- The flashing of the security indicator works to discourage theft.
- A DVD or MP3/WMA disc cannot be registered as the key CD.
- When setting the security on this receiver, register a music CD. Be sure to store the registered music CD somewhere safe.
- When setting the security, the audio is turned OFF.

■ ESN setting screen display

1 Press **MENU**.

2 Touch **Info**.



3 Touch **ESN**.

- The ESN setting screen is displayed.



Main Unit Settings

■ Operation of ESN security

When ESN security is in operation, the navigation and audio functions of this receiver become inoperable when it is disconnected and subsequently reconnected to the battery terminal of the vehicle.

1 Go to the ESN setting screen, load a music CD into the disc insertion slot.

- For disc insertion, see “Loading/Unloading a Disc” on page 22.

2 Touch **Setup**.



3 Touch **YES**.

- The security system is now [ON].
- Touch **NO** to cancel the security setting and return to the preceding screen.



ATTENTION

The registered music CD is required when unlocking the security. It is recommended to make a note of the registered music CD to remind you of which music CD is registered.

■ Unlocking ESN security lock

When you disconnect and then reconnect the battery terminal, the Program reading screen and the Opening screen are displayed first, followed by the Security screen.

1 Insert the registered music CD in the disc insertion slot.

- For disc insertion, see “Loading/Unloading a Disc” on page 22.

2 Touch **YES**.

- This receiver verifies the inserted CD against the registered information, and unlocks the security on completion of the verification.



ATTENTION

- If the music CD cannot be verified, you can make a maximum of five attempts to unlock the security. When verification fails, the Customer enquiries screen is displayed.
- When the Customer enquiries screen is displayed, you can no longer operate this receiver. Please contact customer services.

■ Cancelling ESN security

To reapply the ESN security after cancelling, repeat the process of registering a music CD. See “Operation of ESN security” on page 36

1 Go to the ESN setting screen, load a music CD into the disc insertion slot.

- For disc insertion, see “Loading/Unloading a Disc” on page 22.

2 Touch **Cancel**.



3 Touch **YES**.



■ Setting display of security indicator

You can select whether to use the security indicator which flashes when ESN security is in operation.

CHECK

You cannot set the indicator unless you have registered a music CD in this receiver.

1 Touch **Indicator** on the ESN setting screen.

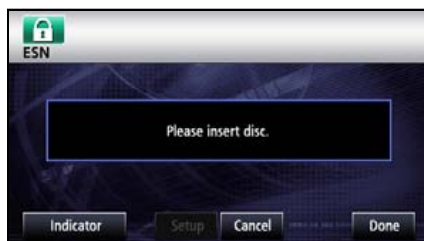

2 Touch **Done**.

Bluetooth Hands-Free Operation

Using Bluetooth Hands-Free

This receiver uses Bluetooth wireless technology to enable use of Bluetooth-supported cell phones. Connection with this receiver allows you to make calls without touching your cell phone. To use a Bluetooth-supporting cell phone with this device, it is necessary to perform Bluetooth registration and connection settings.

- The Bluetooth-supported cell phone to be connected must be a cell phone which supports the relevant Bluetooth specification. For the Bluetooth specification supported by this receiver, see Specification (See page 227).
- Bluetooth is a short-range wireless technology for connecting cell phones, computers and other such devices.



Bluetooth® is a registered trademark of Bluetooth SIG, Inc.



- ① Reception indicator
- ② Battery indicator

Hands-free screen display

1 Press

- The hands-free screen is displayed.
- When a call is in progress, finish the call before pressing .



- Hands-free screen

Registering a cell phone

IMPORTANT

Do not register a cell phone while driving. Be sure to park the vehicle in a safe location and register a cell phone.

Register a cell phone on this receiver. Cell phones can be registered in two ways, from the cell phone, or by searching for the cell-phone on this receiver. Up to 5 cell-phones can be registered. The order of connection precedence is always 1 to 5. When a cell phone is added or deleted, the order of connection precedence is renewed.

Registering from a cell phone

- 1 Touch **Pairing** on the Hands-free screen.



- 2 Touch **Allow Connect.**



- 3 On the cell-phone, enter PIN CODE for this receiver.

- The name of this receiver is ECLIPSE BT.
- The default PIN CODE setting is 1234.
- Perform the cell phone operations with the Device information screen displayed.



- Device information screen

- 4 "Bluetooth Connection Successful" is displayed on completion of registration.

- Registration of the cell phone is now complete.

Register by searching for cell phone on this receiver

- 1 Touch **Pairing** on the Hands-free screen.



- 2 Touch **Device Search.**

- "Searching..." is displayed.



Bluetooth Hands-Free Operation

- 3** Select the device name of the cell phone you wish to register

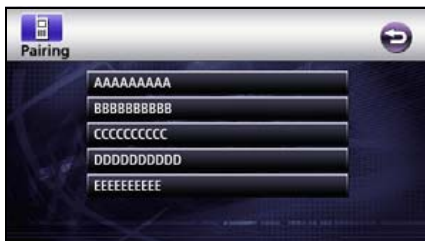

- Search screen

- 4** Enter the PIN CODE on the cell phone.

- The default PIN CODE setting is 1234.
- Perform the cell phone operations with the Device information screen displayed.



- Device information screen

- 5** "Bluetooth Connection Successful" is displayed on completion of registration.

- Registration of the cell phone is now complete.

ATTENTION

- When registration fails, "Bluetooth Connection Failed" is displayed. In this case, repeat the registration operations.
- For cell phone-side operations, consult the instruction manual that came with your cell phone.

Deleting cell phone registration

Delete a cell phone registered on this receiver.

- 1** Touch **Select** on the Hands-free screen.



- 2** Select the cell-phone for deletion



- 3** Touch **Delete**.

- 4** "Bluetooth Connection Successful" is displayed on completion of deletion.

- Deletion of the cell phone is now complete.

ATTENTION

When a cell phone registration is deleted, all call histories and contact data stored on this receiver are also deleted.

■ Connecting a cell phone

Connect a cell phone registered on this receiver.

- 1 Touch **Select** on the Hands-free screen.



- 2 Select the cell-phone for connection.



- 3 Touch **Connect**.

- 4 "Bluetooth Connection Successful" is displayed on completion of connection.

- Connection of the cell phone to this receiver is now complete. (The reception indicator and battery indicators are displayed on the screen.)

ATTENTION

- When connection fails, "Bluetooth Connection Failed" is displayed. In this case, repeat the connection operations.
- Note that you cannot connect unregistered cell phones.

■ Cancelling a cell phone connection.

- 1 Touch **Select** on the Hands-free screen.



- 2 Select the cell phone for which to cancel connection.



- 3 Touch **Disconnect**.

- 4 "Bluetooth Connection Successful" is displayed on completion of cancellation.

- Connection cancellation for the cell phone is now complete. (The reception indicator and battery indicator disappear from the screen.)

Bluetooth Hands-Free Operation

ATTENTION

If the vehicle's battery is disconnected (for repairs to the vehicle or for removing this unit), all the Registered cell-phone, phone book and all call history in the memory will be lost. In such a case, redistilling cell-phone in the memory again.

■ Making a call

⚠ IMPORTANT

Do not make a call while driving. Be sure to park the vehicle in a safe location and make a call.

You can make calls from this receiver by entering a telephone number, or using a stored number (phone book) or incoming/outgoing call history. Note, however, that you cannot make calls from a cell phone that has not been connected.

Entering the telephone number to make the call.

1 On the Hands-free screen, touch **0**, and **1** through **9** to enter the telephone number.

- You can enter telephone numbers of up to 24 digits.
- Touch **Clear** to delete single digit of the entered number.



2 On completion, touch .

- A call is made to the entered number.



Calling from call history

1 Touch **History** on the Hands-free screen.



2 To call from the incoming call history, touch **Incoming Calls**. To call from the outgoing call history, touch **Outgoing Calls**.

- Touch **Delete All** to delete the list data of display mode.



3 Select name or telephone number to call from history.

- Touch ▲ or ▼ to see other names or telephone numbers.

4 Touch .

- Makes a call to the selected telephone number from the history.



Calling from the telephone book

1 Touch **Phone book** on the Hands-free screen.



2 Select person (name or telephone number) to call.

- Touch ▲ or ▼ to see other names or numbers.

Touch **ABC**, **DEF**, **GHI**, **JKL**, **MNO**, **PQRS**, **TUV**, **WXYZ**, or **0-9** to display names starting with the corresponding letters or telephone numbers starting with the corresponding numbers.

- Touch **Data Transfer** to transfer the telephone book to this receiver. Touch **Cancel** to cancel data transfer.



3 Touch .

- Makes a call to number of selected person.



ATTENTION

The incoming and outgoing call histories can store 10 calls for each registered cell phone. For more than 10 calls, the oldest call is deleted.

Bluetooth Hands-Free Operation

■ Receiving a call

You can receive incoming calls in any source mode. When a call arrives, the Calling screen is displayed automatically.

1 When you hear the ringtone, touch .

- You are connected and able to talk. .



● Calling screen

ATTENTION

You can also receive calls automatically. See “Auto Answer settings” on page 45

■ Ending a call (call refusal)

You can end a telephone conversation and refuse calls.

1 Touch  on the Calling screen.

- The call will end.



● Calling screen



ATTENTION



Refused calls are stored in the incoming call history.

■ Adjusting the ringtone volume

CHECK

Make adjustments to the ringtone during ringing.

1 Adjust the volume by pressing  and .

-  : Increase ringtone volume
 : Decrease ringtone volume



ATTENTION



Sound is not emitted unless the ringtone is set to ON.

■ Adjusting the talking volume.

CHECK

Make adjustments to the talking volume when talking.

1 Adjust the volume by pressing  and .

-  : Increase talking volume
 : Decrease talking volume

■ Hands-free settings

You can perform settings for hands-free operation on the Phone setting screen.

- 1 Touch **Setting** on the Hands-free screen.



- 2 On the Phone setting screen, you can perform the following settings using the settings switches.



Phone setting screen

Item	Function
Auto Answer	For setting automatic call acceptance
Ringtone	For setting ringtone
Auto Connect	For setting automatic connection between registered cell phone and this receiver.
Change Code	Touch Change Code to change the PIN CODE.

Auto Answer settings

Start talking five seconds after arrival of incoming call.

- 1 Touch **On** or **Off**.

Ringtone settings

For setting to emit the cell-phone ringtones.

- 1 Touch **On** or **Off**.

Auto Connect settings

For setting automatic connection between registered cell phone and this receiver.

- 1 Touch **On** or **Off**.

PIN Code setting

For changing the PIN CODE.

- 1 Touch **Change Code**.

- 2 Enter over a 4–digit under a 8–digit number.

- Each touch of **Clear** deletes a single character.



- 3 Touch **Done**.

About GPS Navigation

Before Using the GPS Navigation

Simple mode and Advanced mode

The two operating modes of Navigation mainly differ in the menu structure and the number of available features. The controls and screen layouts are the same.

- **Simple mode:** You have easy access to the most important navigation functions and the basic settings only. The rest of the settings are set to values that are optimal for typical use.
- **Advanced mode:** You have access to the full functionality of Navigation.
Switching from Simple mode to Advanced mode: From the start screen (Navigation menu), touch [Settings], [Advanced Mode].
- **Switching from advanced to Simple mode:** From the start screen (Navigation menu), touch [Settings], [Simple Mode].

Viewing Navigation Screen

Screen switches and other operations

When using Navigation, you usually touch the switches on the touch screen.

You only need to confirm selections or changes in Navigation if the application needs to restart. Otherwise, Navigation saves your selections and applies the new settings without confirmation as soon as you use the controls.

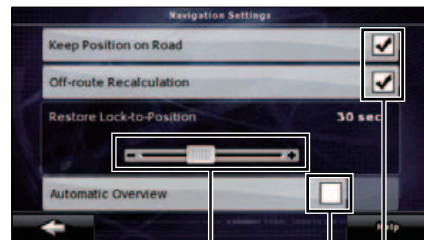
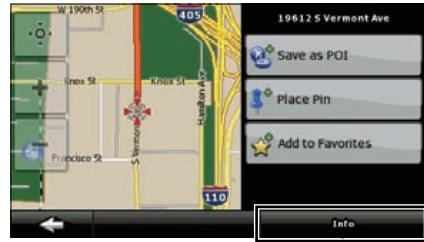

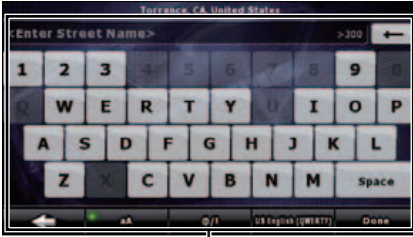

Type	Example	Description	How to use
Virtual keyboard	⑥	Alphabetic and alphanumeric keyboards to enter text and numbers.	Each key is a touch screen switch.

Type	Example	Description	How to use
Touch switch	①	Touch to initiate a function, to open a new screen, or to set a parameter.	Only one touch is required.
Icon	②	Shows status information.	Some icons also function as switches. Only one touch is required.
List	③	When you need to select from several options, they appear in a list.	Move between pages by touching the switches of ③.
Slider	④	When a feature has several different unnamed values, Navigation shows an indicator on a gauge for displaying and setting a value from a range.	<ul style="list-style-type: none"> ● Drag the handle to move the slider to its new position. ● Touch position of handle on slider. Move your finger.
Check switch	⑤	When there are only two options, a checkmark shows whether the feature is enabled.	Touch to turn the switch on or off.

Navigation Overview

Navigation Menu



This is the Navigation menu. From here, you can access the following screens. Touch the following switch on map screen: [Menu]

Screen	Touch switch	Description
Map	[Map]	The Map screen.
Find	[Find]	Select destination (for example an address or a POI) or use the search engine of Navigation for any other reason (for example to look for the phone number of a POI).
Route	[Route]	Manage an active route (obtain information relating to route, modify or delete route or part of route.) Also, plan route without GPS reception.
Manage	[Manage]	Manage user data such as saved locations (POI, Favorites, Pins, and History), saved routes, and Track Logs.
Settings	[Settings]	Manage the behavior of Navigation, including the map layout during navigation, language and warnings.

Navigation Details Setting Screen

■ Settings menu

You can configure the program settings, and modify the behavior of Navigation. Touch the following switches: [Menu], [Settings]

The Settings menu has two pages of submenus. Touch  to access the other options.





Touch switch	Description	Reference
[Map Screen]	You can fine-tune the appearance and content of the Map screen.	52
[Route Planning]	These settings determine how routes will be calculated.	53
[Navigation]	You can control how Navigation behaves during navigation.	55
[Sound]	You can adjust the voices of Navigation.	61
[Regional]	These settings allow you to customize the application for your local language, measurement units, time and date settings and formats, as well as to choose the voice guidance profile you prefer.	55
[Warnings]	You can enable some useful warnings, and disable the touch screen in a moving vehicle with Safety Mode.	56
[Menu]	You can modify the look and behavior of the Menu screens.	57
[Track Logs]	You can set up automatic Track Log saving and fine-tune related settings.	57
[Traffic INFO]	You can check connecting information of SIRIUS Traffic.	58
[About]	This screen has no navigation feature. It merely provides information about the maps and licenses included with your navigation system.	None
[Simple Mode]	You can switch to Simple Mode. In Simple Mode only a few of the above settings are available. The remaining settings are set to the optimal values for typical use.	46



Navigation Overview

■ Quick Menu



The Quick menu is a selection of controls that are frequently needed during navigation. It is opened from the Map screen. Touch the following switches on the map: 

Touch the switch in the Quick menu to start the Map screen immediately. Switches are on when lit up.

Name	Main function (single touch)	Function (touch and hold)
	3D buildings can be displayed on the map. Use this switch to suppress them temporarily.	Opens 3D settings.
	Turn Track Logs on and off. This function can also be controlled from the Manage Track Logs screen.	Opens Manage Track Logs screen.
[GPS]	Opens the GPS Data screen, which includes satellite information, data coming from the GPS receiver, and a shortcut to the GPS Setting screen if needed.	No action
[TMC]	When a SIRIUS Traffic receiver is connected to Navigation, this switch opens the list of Traffic messages.	No action

■ Route menu

Save, load and edit your routes. Touch the following switches: [Menu], [Route]

Touch switch	Description	Reference
[Route Info]	Opens a screen with useful route data.	85
[Itinerary]	You can browse the driving instructions that Navigation follows during navigation. You can exclude maneuvers or streets to adjust the route to your preferences.	84
[Edit Route]	Modify routes: Delete route points or modify their order.	85
[Load Route]	You can load a previously saved route for navigation.	78
[Save Route]	You can save the active route for later use.	77
[Delete Route]	You can delete the active route and all the route points (start point, via points, and destination). If you later decide that you need the same route, you will have to rebuild it from scratch.	102
[Settings]	Opens the Route settings screen with controls to modify the road types used for route calculation and the route calculation method.	53
[Fly Over]	You can run a demonstration of the route at high speed.	104
[Simulate]	You can run a demonstration of the route at normal speed.	104

■ Management menu

You can manage the content that this unit stores. Touch the following switches: [Menu], [Manage]

Touch switch	Description	Reference
[Save Routes]	Renaming or deleting saved routes	103
[Track Logs]	Recording, simulating, renaming or deleting Track Logs, assigning them a color to be shown on the map	103
[POI]	Creating, updating or deleting POIs Creating, updating or deleting POI groups Modifying POI visibility setting	82
[History]	Deleting histories	102
[Favorites]	Renaming or deleting Favorites	105
[Saved Search Criteria]	Creating, renaming or deleting saved search criteria	87
[User Data Management]	You can manage the data you have saved and the settings you have made in the program.	52

Navigation Overview

■ User data management

You can manage settings implemented for saved data (Pins, POI, Favorites, History, and Track Logs) and programs. Touch the following switches :[Menu], [Manage], [User Data Management]

Touch switch	Description
[Remove Pins]	You can add Pins to locations on the map using the [Place Pin] switch from the Cursor menu(See page 63). Touch this switch to remove all Pins from the map.
[Back Up User Data]	All user data and the current settings will be saved on the inserted memory card. There is always one backup file. If you perform a backup later, the previous backup will be overwritten with the new information.
[Restore User Data]	All user data and settings will be overwritten with the information stored in the backup file. Data and settings created after the latest backup will be lost.
[Delete User Data]	All user data will be deleted, and settings will return to their factory defaults. This unit will restart.
[Reset All Settings]	All settings will return to their factory defaults, but no user data will be deleted. This unit will restart.

■ Map screen settings

You can fine-tune the appearance and content of the Map screen. Touch the following switches: [Menu], [Settings], [Map Screen]

Touch switch	Description
[3D Settings]	Use 3D settings to determine which of the present 3D objects are shown on the map, and adjust the level of 3D visual detail. The options are as follows: <ul style="list-style-type: none"> ● Landmarks: Landmarks are 3D artistic or block representations of prominent or well-known objects. 3D landmarks are only available in selected cities and countries. ● Elevated roads: Complex intersections and vertically isolated roads (such as overpasses or underground tunnels) are displayed in 3D. ● Building visibility: Full 3D city building data that represents actual building size and position on the map. Building data is limited to the city centers of major cities in the US. ● Terrain detail: 3D terrain map data shows changes in terrain, elevations or depressions in the land when you view the map. Use it to plot the route map in 3D when you navigate.
[Color Profiles]	Navigation is able to show the map and the menus in different colors during the day and night. Select the color profiles to be used in each mode, and the daytime and night color profiles interlock lighting and lighting out of vehicle.
[Elevation on 2D Map]	You can display 3D information on 2D map. These top-down maps can display elevation by colors and shading.

Touch switch	Description
[Street Names During Navigation]	Street names and POI icons can get in the way on the map during navigation. With this switch you can suppress these map elements when Navigation is following your position on the map. If you move the map, both the street names and POI icons reappear immediately.
[Lane Information]	Some maps contain lane information to help you position your car in the upcoming intersection. This setting tells Navigation whether to display this information at the top or at the bottom of the map. You can prevent the display of lane information.

■ Route planning option

These settings determine how routes will be calculated. Touch the following switches: [Menu], [Settings], [Route Planning]

Touch switch	Description
[Road Types Used for Route Planning]	To make the route fit your needs, you can also set which road types are, where possible, to be considered for and excluded from the route. Excluding a road type is a preference. It does not necessarily mean total prohibition. If your destination can only be accessed using some of the excluded road types, they will be used but only as much as necessary. In this case a warning icon will be shown on the Route Information screen, and the part of the route not matching your preference will be displayed in a different color on the map.
[Route Calculation Method]	You can choose from different route types. The routing method can be changed temporarily while creating the route: When selecting the destination, touch [Routing Methods] in the Cursor menu. Touch [Routing Methods].
[Use Traffic Information]	When traffic messages are received, this setting tells Navigation whether to use that information in route planning.
[Recalculate To Avoid Traffic]	This setting determines how Navigation uses the received Traffic information in route recalculation: <ul style="list-style-type: none"> ● Automatic: When route recalculation becomes necessary based on the received Traffic events, Navigation recalculates the route automatically. ● Manual: When route recalculation becomes necessary based on the received Traffic events, Navigation notifies you, but you can decide whether to recalculate the route or not. ● Disabled: Traffic events are only taken account when the route is recalculated in an off-route situation.

Navigation Overview

Road Types Used for Route Planning:

Type	Description
[Unpaved Roads]	Navigation excludes unpaved roads by default: Unpaved roads can be in a bad condition and usually you cannot reach the speed limit on them.
[Highways]	You might need to avoid highways when you are driving a slow car or you are towing another vehicle.
[Ferries]	Navigation includes ferries in a planned route by default. However, the map does not necessarily contain information about the accessibility of temporary ferries. You might also need to pay a fare on ferries.
[Cross-border Planning]	In some cases the route calculated according to your other navigation and route preferences will lead through another country. If you wish to always stay within the same country, turn this option off.
[Permit Needed]	You might need a permit or permission from the owners to use certain roads or to enter certain areas. Navigation excludes these roads from the route calculation by default.
[Pre-use Toll]	By default Navigation includes toll roads (pay roads where there is a per-use charge) in the routes. If you disable toll roads, Navigation plans the best toll-free route.
[Period Charge]	Charge roads are pay roads where you can purchase a pass or vignette to use the road for a longer period of time. They can be enabled or disabled separately from toll roads.
[Carpool/HOV]	This control appears only when navigating in the USA. You should check whether you are allowed to use carpool lanes before enabling this road type.

Route calculation methods:

Option	Description
Fast	Gives the quickest possible route if you can travel at or near the speed limit on all roads. Usually the best selection for fast and normal cars.
Easy	Results in a route with fewer turns. With this option, you can make Navigation take, for example, the freeway instead of series of smaller roads or streets.
Economical	Look for trade off of speed and shortness with cost. Navigation calculates as if it were calculating the Fast route, but it takes other roads as well to save on fuel costs.
Short	Gives a route that has the smallest total distance of all possible routes between the route points.

■ Navigation settings

You can control how Navigation behaves during navigation. Touch the following switches: [Menu], [Settings], [Navigation]

Touch switch	Description
[Keep Position on Road]	This feature allows car drivers to always correct GPS position errors by matching the vehicle position to the road network. By turning off this feature, you also turn off the GPS position error filtering. The position shown on the map will be subject to all position errors and position fluctuations.
[Off-route Recalculation]	This switch tells Navigation whether to automatically recalculate the route when you deviate from it. When this feature is switched off, it is necessary to start route recalculation manually. Otherwise, navigation will stop until you return to the recommended route. Setting a point other than the current GPS position as the start point of the active route will automatically disable this feature.
[Restore Lock-to-Position]	If you have moved or rotated the map during navigation, this feature moves the map back to your current GPS position and re-enables automatic map rotation after the given period of inactivity.
[Automatic Overview]	This feature switches the map view to Overview mode when the next route event is far away. Overview is a zoomed out 2D view to let you see the surrounding area. You have the following controls for Automatic Overview: <ul style="list-style-type: none">● Turn Distance for Overview: The map view will be switched to Overview mode if the next route event is at least as far as this value.● Default Zoom Level: Overview mode will appear with this zoom level. You can scale the map in Overview mode but when Overview appears again, this zoom level will be applied.

■ Regional settings

These settings allow you to customize the application for your local language, measurement units, time and date settings and formats, as well as to choose the voice guidance profile you prefer. Touch the following switches: [Menu], [Settings], [Regional]

Touch switch	Description
[Program Language]	This switch displays the current written language of the Navigation user interface. By touching the switch, you can select a new language from the list of available languages. Changing this setting causes the application to restart. Be aware of this before you make the change.
[Voice Profile]	This switch displays the current voice guidance profile. By touching the switch, you can select a new profile from the list of available languages and speakers. Touch any of these to hear a sample voice prompt. Just touch OK when you have selected the new spoken language.

Navigation Overview

Touch switch	Description
[Units]	You can set the distance units to be used by the program. Navigation may not support all the listed units in some voice guidance languages. If you select a measurement unit not supported by the chosen voice guidance language, a warning message will appear.
[Set Date & Time Format]	You can set the data and time format. A variety of international formats are available.
[Time and Time Zone Settings]	You can access time and time zone settings. Navigation helps you with correcting the device time to ever accurate GPS time. Navigation can also help you set the time zone based on your current GPS position.

Time and Time Zone Settings

Touch switch	Description
[Auto Time Correction to GPS]	Use this feature to synchronize the clock of your device to the highly accurate time provided by the GPS receiver.
[Use Auto Time Zone]	Use this feature to synchronize the time zone of the clock of your device to the time zone based on your current GPS position. This is useful if you travel abroad.
[Set Time Zone]	Set time zone manually if you do not want to synchronize the time zone automatically. This allows you to use Auto Time Correction and apply a time zone offset to obtain the desired time.

The clock function of this unit interlocks GPS signal.

The clock may be out of order when not receiving GPS signal.

■ Warning settings

You can enable some useful warnings, and disable the touch screen in a moving vehicle with Safety Mode. Touch the following switches: [Menu], [Settings], [Warnings]

Touch switch	Description
[Warn When Speeding]	<p>Maps may contain information about the speed limits of the road segments. Navigation is able to warn you if you exceed the current limit. This information may not be available in your district (ask your local dealer). Also, this information may not be completely accurate for all roads on the map. This setting lets you decide whether you wish to receive the warnings. You can set the relative speeding level at which the application warns you (100% represents the current speed limit):</p> <ul style="list-style-type: none"> ● In built-up areas ● Elsewhere: at all other locations <p>There are two types of warnings. You can turn them on or off independently:</p> <ul style="list-style-type: none"> ● Audible warning: A voice message is played using the selected voice guidance profile. ● Visible warning: A symbol with the speed limit appears in the corner of the map (for example: )

Touch switch	Description
[Speed Camera Warning]	This feature allows you to receive a warning when approaching a Road Safety Camera. You must ensure on your own liability that using this feature is legal in the country where you intend to use it. The options are as follows: <ul style="list-style-type: none"> ● Audible Warning: Plays back buzzer sound as you approach a camera. You can also limit the warning to playing when you are over the speed limit on approach. ● Visual warning: The type of the camera and the monitored speed limit appear on the Map screen as you approach.
[Safety Mode]	Safety Mode disables the touch screen above 10 km/h (6 mph) to keep your attention on the road. While driving, you will not be able to set a new destination or change settings. The only screen control that remains enabled is the gesture that puts you back on the Map screen.

■ Menu settings

You can modify the look and behavior of the Menu screens. Touch the following switches: [Menu], [Settings], [Menu]

Touch switch	Description
[Animation]	You can activate and deactivate the Menu animations. When animation is turned on, switches on Menu and keyboard screens are animated.
[Background]	You can choose the image to be used as the menu background image.

■ Track log settings

You can set up automatic Track Log saving and fine-tune related settings. Touch the following switches: [Menu], [Settings], [Track Logs]

Touch switch	Description
[Update Interval]	This determines how often track points will be saved. Position information is normally received once a second from the GPS. If you do not need such a detailed log, you can increase this number to save Track Log space.
[Enable Auto-saving]	When auto-saving is enabled, you do not need to turn Track Log saving on and off manually. Navigation will automatically start recording the Track Log as soon as GPS position is available.
[Track Log Database Size]	This figure shows how much memory is used by the automatically saved Track Logs.
[Track Log Max. Size]	You can set the maximum database size for the automatically saved Track Logs. When the limit is reached, the oldest automatically saved Track Logs will be deleted.
[Create NMEA/SIRF Log]	Independently of the normal Track Log, you can instruct Navigation to record the native GPS data received from the GPS device. This information is saved as a separate text file on the memory card and cannot be played back by Navigation.

Navigation Overview

■ TMC settings

You can set up the connection to the SIRIUS Traffic receiver. Touch the following switches: [Menu], [Settings], [Traffic INFO]

■ Safety Mode settings

This feature is available in Advanced mode only.

Touch the following switches: [Menu], [Settings], [Warnings], [Safety Mode]

■ Trip information screen



The Trip information screen has both route and travel data you might need during your journey. It can be opened directly from the Map screen by touching the Trip Data field.



The fields on this screen are continuously updated while the screen is open.

When you open the screen, all route data fields contain information about reaching your final destination. Touch [Next Via Point] to have the fields relating to your route display data for the next via point. Touch the switch repeatedly to toggle between the two options.





You have the following data and functions on this screen:

Name	Description	Function
 	Shows whether the route data fields are displaying information about the final destination (checkered flag) or about the next via point (yellow flag).	None
Field next to the flag	Shows the name or number of the current street or road.	None
Turn Preview	Shows the type and distance of the next route event.	None
Compass	Shows the current heading.	Touch this field to show it on the Map screen in one of the Trip Data fields.

Name	Description	Function
Speedometer	Shows the current speed both graphically and as a number.	Touch this field to show it on the Map screen in one of the Trip Data fields.
Distance Remaining	Shows distance remaining to final destination.	Touch this field to show it on the Map screen in one of the Trip Data fields.
Time Remaining	Shows the time needed to reach the final destination of the route based on information available for the remaining segments of the route. The calculation cannot take into account traffic jams and other possible delays.	Touch this field to show it on the Map screen in one of the Trip Data fields.
Arrival Time	Shows the estimated arrival time at the final destination of the route based on information available for the remaining segments of the route. The calculation cannot take into account traffic jams and other possible delays.	Touch this field to show it on the Map screen in one of the Trip Data fields.
GPS Time	Shows the current time corrected with time zone offset. The accurate time comes from the GPS satellites, and the time zone information either comes from the map or is set manually in Regional settings.	Touch this field to show it on the Map screen in one of the Trip Data fields.
Altitude	Shows elevation if it is provided by the GPS receiver.	Touch this field to show it on the Map screen in one of the Trip Data fields.
Speed Limit	Shows the speed limit of the current road if the map contains it.	Touch this field to show it on the Map screen in one of the Trip Data fields.
Trip Computer		Opens a new screen with three resettable Trip Computers.
Next Via Point		Touch this switch to change the content of the Route Data fields to show information about the next via point. If you touch the previous switch, this one replaces it.
[Destination]		Touch this switch to have the Route Data fields show information about the final destination again.

Most of the fields on this screen have a symbol next to them. This symbol shows whether the field it is attached to is shown on the map as Trip Data. It also shows the position of the data as follows:

Navigation Overview

Symbol	Description
	This value is not shown on the Map screen.
	This value appears on the Map screen in the Trip Data area. This is the value at the top.
	This value appears on the Map screen in the Trip Data area. This is the value in the middle.
	This value appears on the Map screen in the Trip Data area. This is the value at the bottom.

■ Trip computer screen

The Trip computer screen provides collected trip data. Touch [Trip Computer] on the Trip information screen to open the Trip computer screen.

The fields on this screen are continuously updated while the screen is open.

You can switch between trips, pause and resume a trip, or reset.

You have the following functions on this screen:

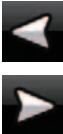
Name	Description
[Pause]	Pauses the trip currently shown on the screen. Values on the screen stop changing.
[Reset]	Resets all counters of the currently shown trip. The collection of trip data is restarted only when Navigation receives a position from the GPS.
	Cycles through all trips.

ATTENTION

If the vehicle's battery is disconnected (for repairs to the vehicle or for removing this unit), all the Trip Computer history (Average Speed, Total time, etc) in the memory will be lost.

Screen Adjustment and Setting

■ Day screen and night screen

This unit uses different color profiles during the day and during the night.

- Daytime colors are similar to those of paper road maps.
- The night color profiles use dark colors for large objects to keep the average brightness of the screen low.

This unit offers different daytime and night color profiles. You can switch the daytime and night color profiles based on lighting and lighting out of vehicle.

■ Screen color in tunnels

When entering a tunnel, the colors of the map change. All buildings disappear, and large objects (such as surface waters or forests) and empty areas between roads become black. However, roads and streets keep their original colors from the daytime or night color scheme currently in use.

After leaving the tunnel, the original colors return.

■ Volume settings

You can adjust the sounds of Navigation. Touch the following switches: [Menu], [Settings], [Sound]

Touch switch	Description
[Voice Guidance Volume]	The slider adjusts the loudness of voice prompts. At the left-end, you cannot hear the voice guidance. At the right-end, the volume is high.
[Dynamic Volume]	When driving at high speed, the noise in the car may be too loud to clearly hear the voice guidance and other sounds. Using Dynamic Volume you can instruct Navigation to increase the volume when your speed exceeds a given minimum, and reach its highest volume at the given maximum speed.
[Dynamic Volume Settings]	You can adjust a maximum and minimum speed of speed range to volume up.

Navigation Overview

Map Display







■ Present location display

Access from the Navigation menu by touching [MAP].



For further information about the Map screen, see “Map screen” on page 78.

Navigation displays the route as follows.

Symbol	Name	Description
	Current GPS position	Your present position displayed on the map.
	Cursor (selected map position)	The location selected in the Find menu, or a map point selected by touching the map.
	Start point	<p>The first point of the route.</p> <p>Normally, if GPS position is available, it is used as the start point of the route. If there is no valid GPS position, Navigation uses the last known GPS position as the start point.</p> <p>When you are using a saved route, Navigation asks you if you want to use your GPS position or the first point in the saved route as the start point.</p> <p>You can also modify the start point in the Cursor menu. If you do so, automatic off-route recalculation needs to be turned off to keep the selected point as the start point.</p> <p>If automatic off-route recalculation is disabled for any of the above, touching the  icon in the Turn Preview field not only initiates route recalculation from the current GPS position, but also re-enables the automatic off-route recalculation.</p>
	Via point	The via points are intermediate destinations. You can place as many via points as you want.
	Destination (end point)	The last point of the route, the final destination.







Symbol	Name	Description
	Route color	The route stands out against the map, both in daytime and night color modes. The active leg of the route is always displayed in a brighter shade than the inactive (upcoming) legs.
	Active leg of the route	The section of the route on which you are driving. If no via points have been added (destination only), the entire route becomes the active leg. When via points have been added, the active leg is the section of the route from the present location to the next route point (the next via point or the final destination if there are no more via points).
	Inactive leg of the route	Upcoming sections of the route. Each of these becomes active when you arrive at the corresponding via point.
	Streets and roads that are excluded from the navigation	You can select whether or not to use certain road types. (See page 53) However, when Navigation cannot avoid such roads, the route will include them, showing them in a different color to the route.

■ Cursor menu

As soon as you select a location in the Find menu, the map appears with the Cursor menu which provides possible actions for the selected point.

Alternatively, touch the map to make the control switches appear. Touch again to place the Cursor, a radiating red dot. Now touch again to open the Cursor menu with a list of options.

Since the Cursor menu only displays a portion of the map, the menu initially includes only a few switches. Touch [More Options] to open all options.

Touch switch	Description
	Closes the Cursor menu, and returns to the previous screen.
	Zooms out the map.
	Zooms in the map.
	You can move the map and zoom in and out while the Cursor menu is open. Touch anywhere on the map to place the Cursor in a new location. Use this switch to return the Cursor to the position it occupied at when the Cursor menu was opened.
	Displayed at the Cursor when it is at the position it occupied when Cursor menu was opened.
	Displayed at the Cursor if it has been relocated since the Cursor menu was opened.

Navigation Overview

Touch switch	Description
[Info]	Opens a new screen showing the address of the Cursor and nearby POIs.
[More Options]	Opens the full-screen Cursor menu with all the available options.
[Set as Destination]	Creates a new route with the Cursor as the destination. The previous route (if one exists) is deleted.
[Remove Destination]	When the cursor is at the destination or nearby, this switch replaces the previous switch, and the present location disappears from the route. The last via point is promoted as destination, or if there are no via points, the route is deleted.
[Insert as Via]	The Cursor is added to the active route as an intermediate route point, a point to be reached before the destination. If the route already includes via points, the Edit route screen will open. This screen shows where on the route the via point will be displayed.
[Remove Via]	When the cursor is at or near one of the via points, this switch replaces the previous switch, and the selected via point disappears from the route. The route is recalculated without the deleted point.
[Continue]	Adds Cursor to the end of the route as new destination. The previous destination is demoted, and becomes the last via point.
[Routing Methods]	This switch resembles [Set as Destination]. Here, however, a new screen opens, and routes are calculated using all available calculation methods (fast, short, economical, easy). Observe the results, and choose one of the routes to navigate.
[Set as Start]	The Cursor becomes the start point of the route. This means that the route is not started from the current GPS position, and Automatic Off-route Recalculation needs to be turned off to keep the selected point as the start point.
[Remove Start]	When the cursor is at the start point or nearby, this switch replaces the previous switch and the start point disappears from the route. The current GPS position is again used as the start point, and Automatic Off-route Recalculation is re-enabled.
[Save as POI]	The Cursor is saved as a user POI. Select the POI group, name the POI, select a suitable icon, and enter a phone number and additional information as appropriate.
[Place Pin]	Map locations can be marked with Pins. Unlike POIs, Pins have no names and other details, only colors to let you tell them apart on the map.
[Remove Pin]	When the cursor is at or near a pin, this switch replaces the previous switch, and you can delete the pin.
[Add to Favorites]	Adds Cursor location to list of frequently visited destinations, or Favorites. You can name the Favorite.
[Save as Camera]	The Cursor is saved as the location of a Road Safety Camera (speed camera or red light camera). A new screen appears where you can set the type of the camera, the direction of the measured traffic, and the speed limit checked.
[Edit Camera]	If the Cursor is at or near a Road Safety Camera, this switch replaces the previous one, and opens a new screen where you can edit the details of the camera.

■ Position menu

When you follow the recommended route on the map (the Cursor is the current GPS position), the Position menu replaces the Cursor menu. It does not contain switches that modify the current route, as the GPS position is not useful as a route point.

To open Position, touch [Position].

■ Checking vicinity information

- If you are interested in the details of your present position during navigation:

1 Check the bottom line of the map. It shows the current street and house number information.

2 For details, touch [Position] to open the Position menu.

3 Touch [Info]. The address, coordinates and a list of nearby POIs are displayed.

- You can check the details of any other location by selecting it on the map:

1 Touch the map anywhere to open the map control switch.

2 Touch the desired location on the map. The Cursor (📍) appears there. The address of the location is displayed at the bottom of the map.

3 For further details, touch [Cursor] to open the Cursor menu.



4 Touch [Info]. The address, coordinates and a list of nearby POIs are displayed.

- It is even easier if you select the desired point in the Find menu. Then the Cursor menu opens automatically. Just touch [Info].







Navigation Overview











■ Map menu operations

Position marks on map



- Current GPS position:  (See page 62)
- Selected location (Cursor):  (See page 63)

The following controls help you modify the map view to best suit your actual needs. Most of these controls appear with a single touch of the map, and disappear after a few seconds of inactivity.

Action	Touch switch	Description
Moving the map with drag&drop	None	You can move the map in any direction: Touch and hold the map, and move your finger in the direction in which you want to move the map. If GPS position is available and you have moved the map,  switch appears. Touch this switch to return to the GPS position.
Opening/closing map control switches		Touch this switch to show or hide the following map control switches: <ul style="list-style-type: none"> ● Zoom in/out ● Rotate left/right (3D map only) ● Tilt up/down (3D map only) ● Zoom preset switches (2D map only) ● Tilt and zoom preset switches (3D map only) ● Return to GPS position switch ● Smart Zoom
Zooming in and out	 	Changes how much of the map is displayed on the screen. Navigation uses high-quality vector maps that let you see the map at various zoom levels, always with optimized content. Street names and other text is always shown in the same font size and correctly orientated. You can restrict the view to required streets and objects. The limits on zooming differ for the 2D and 3D map viewing modes.
Tilting up and down	 	Changes the vertical view angle of the map in 3D mode.



Action	Touch switch	Description
Rotating left and right	 	<p>Changes the horizontal view angle of the map in 3D mode.</p> <p>When GPS position is available, Navigation always rotates the map so its top faces your direction of travel (Track-Up orientation). You can turn away from Track-Up with these switches.</p> <p>If GPS position is available and you have rotated the map, the  switch appears. Touch this switch to re-enable the automatic map rotation.</p>
Viewing modes	  	<p>The following map perspectives are provided in Navigation:</p> <ul style="list-style-type: none"> ● Perspective view (3D) ● Classic top-down view (2D) ● North up <p>The icon always shows the mode the switch switches to:</p> <p>In 3D mode,  is displayed. Touch to switch to 2D mode. In 2D mode,  is displayed. Touch to switch to North up mode. In North up mode,  is displayed. Touch to switch to 3D mode.</p>
Smart Zoom		<p>Navigation can automatically rotate, scale and tilt the map and give you the optimal view:</p> <ul style="list-style-type: none"> ● When you approach a junction, it will zoom in and raise the view angle to let you easily recognize your maneuver. ● If the next junction is at a distance, Navigation zooms out and lowers the view angle to show you the road in front of you. <p><u>Touch this switch once to enable Smart Zoom.</u></p> <p><u>Touch and hold this switch once to set the zoom limit on Smart Zoom.</u></p>
Return to normal navigation (Return to GPS position with automatic map rotation)		<p>Touch this switch to move the map back to the current GPS position. If the map has been rotated in the 3D mode, automatic map rotation is also re-enabled.</p>



Navigation Overview

Action	Touch switch	Description
Zoom preset (Advanced mode only)		<p><u>Touch the preset switch once to set the zoom level to a fixed predetermined value.</u> Smart Zoom is disabled. These switches are available in 2D mode.</p> <p><u>Touch and hold the desired switch to set the zoom value as the current zoom level, or reset to an original value.</u></p>
Tilt and Zoom preset (Advanced mode only)		<p><u>Touch the preset switch once to set the zoom level to a fixed predetermined value.</u> Smart Zoom is disabled. These switches are available in 3D mode.</p> <p><u>Touch and hold the desired switch to set the zoom value as the current zoom level, or reset to an original value.</u></p>
Map scale		Navigation shows the scale of the map in 2D mode.
Fit to screen	[Fit to screen]	<p>This switch is not shown on the Map screen. It is available on the following screens:</p> <ul style="list-style-type: none"> ● Plan on map screen: When you have an active route, you can display it in its full length on the map. ● Track information screen: A Track Log can be displayed in its full length on the map.



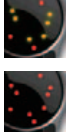



■ Map screen status information and hiding operation

The following information appears in the rounded field in the top left corner, the Turn Preview field. When you touch this area, the result depends on what information is currently shown.

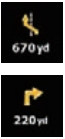

Icon	Information	Details	Action
	There is no active route in Simple mode.	When there is no active route in Simple mode, this icon is displayed in the Turn Preview field.	Touch this area to open Find Address.
	There is no active route in Advanced mode.	If there is no route to be navigated in Advanced mode, this icon appears in the Turn Preview field.	Touch this area to open Find.
	There is no valid GPS position.	If an active route exists, and there is no valid GPS position, the view of the sky above you is shown with colored dots for each satellite. Some dots need to turn green to allow navigation.	Touch this area to open the Route information screen.

Icon	Information	Details	Action
	If the icon is a static picture, route calculation is needed.	GPS position and an active route are available, but automatic off-route recalculation is switched off, and you deviated from the route.	Touch this area to make Navigation recalculate the recommended route.
	This icon indicates that route calculation is in progress.	Navigation is calculating or recalculating the route.	Nothing happens if you touch this area of the screen.
	Next route event (Next action)	GPS position and an active route are available, and you are navigating the recommended route. This area gives you information about the type and distance of the next route event.	Touch this area to open the Route information screen.







The following area appears next to the above described rounded area. When you touch this area, the result depends on what information is currently shown.

Icon	Information	Details	Action
	There is no valid GPS position.	If there is no valid GPS position, this symbol appears here.	Touch this area to open the GPS Data screen to check the signal status or the connection settings.
	Traffic restriction	When GPS position is available but there is no route to be navigated, any traffic restrictions at upcoming intersections are shown here.	Nothing happens if you touch this area of the screen.
	Second route event (maneuver after next maneuver)	When GPS position and an active route are both available, this field shows the route event that follows the next route event shown in the above described area.	Touch this area to open the Itinerary screen with the turn by turn guidance instructions.
	Approaching a Road Safety Camera	This icon appears when you are approaching a Road Safety Camera, and the warning for cameras is enabled in Settings.	Touch this area to suppress the audible camera warning.
	Stops the running simulation	This icon is displayed during fly overs, route simulation and Track Log playback.	Touch this area to stop the simulation.
	Recalculating route	During route recalculation, this field shows the recalculation progress between 0% and 100%.	Nothing happens if you touch this area of the screen.

Navigation Overview





Icon	Information	Details	Action
	Indicator strip	<ul style="list-style-type: none">  Track Log recording  TMC status 	Nothing happens if you touch this area of the screen.







The following symbols appear in the Indicator strip:

	Navigation records a Track log when GPS position is available.
	Track log recording is disabled.
	No SIRIUS Traffic receiver is connected or SIRIUS Traffic is turned off.
	A SIRIUS Traffic receiver is connected and a SIRIUS Traffic data is received.
	There are new, unread Traffic events.
	A part of the route is bypassed based on Traffic events.
	A part of the route is mentioned in Traffic events but it has not been bypassed (for example, even the best detour would be too long) or could not be bypassed (for example, the destination is on a congested street).



There are two fields reserved on the Map screen to display the next two maneuvers (route events that are listed in the Itinerary). Both the type of the event (turn, traffic circle, exiting freeway, etc.) and its distance from the current GPS position are displayed.

Most of these icons are very intuitive and known as road signs. The following table lists some of the frequently shown route events. The same symbols are used in both fields:

Icon	Description
	Turn left.
	Turn right.
	Turn back.
	Bear right.

Icon	Description
	Turn sharp left.
	Keep left.
	Continue straight in the intersection.
	Enter traffic circle. The number of the exit is shown in the circle, but only for the next turn.
	Enter freeway.
	Exit freeway.
	Board ferry.
	Leave ferry.
	Approaching the next via point.
	Approaching the destination.





The following information is displayed in three fields displayed on the Map screen. Touch this area to open the Trip Information screen, and select from values displayed in the three fields. When there is no active route, these fields show the following information. : Current speed, compass and current time.

Icon	Type	More information
	Compass	Shows the direction of your heading both when the map is automatically rotated (3D) and when the map is always facing North (2D).
	Speed information	There are speed values that can be shown. <ul style="list-style-type: none"> ● Current speed ● Speed limit on the current road
	Time information	There are time values that can be shown. <ul style="list-style-type: none"> ● Current GPS time ● Time remaining to the destination ● Time remaining to the next via point ● Estimated arrival time at the destination ● Estimated arrival time at the next via point

Navigation Overview

Icon	Type	More information
	Distance information	<p>There are distance type values that can be shown.</p> <ul style="list-style-type: none"> ● Distance remaining to destination ● Distance remaining to next via point ● Current altitude

GPS reception quality shows the current accuracy of the position information.

Icon	Description
	GPS receiver not connected. GPS navigation is not possible.
	Navigation is connected to the GPS receiver, but the signal is too weak and the receiver cannot determine the GPS position. GPS navigation is not possible.
	<p>GPS navigation is not possible.</p> <p>Only a few satellites are received. Position information is available, but elevation (altitude) cannot be calculated. GPS navigation is possible, but the position error may be significant.</p>
	<p>Altitude information is available, the position is a 3D position.</p> <p>GPS navigation is possible.</p>

ATTENTION

Touch the following status field to open the Quick menu (See page 50).

Icon	Status	More information
	GPS position quality	A higher number of lit bars indicates better GPS position accuracy.

■ Using the Cursor (at selected position)

First, place the Cursor at the desired map location with one of the following options:

- Use the Find menu to select a location. The map returns with the selected point (the Cursor) in the middle, and the Cursor menu appears with the available options.
- Touch the screen twice to place the Cursor at the desired location. Touch the cursor to open the [Cursor] menu.

The following actions are available.

Touch switch	Action
[Set as Destination]	On an active route, use the Cursor as the destination by resetting the previous destination.
[Insert as Via]	On an active route, use cursor as via point (intermediate location) before destination (only available in Advanced mode).

Touch switch	Action
[Place Pin]	Marks the map with a Pin at the Cursor (available in Advanced mode only).
[Routing Methods]	Shows the different routes calculated by the available routing methods. Choose the one that best suits your needs (available in Advanced mode only).
[Set as Start]	On an active route, use the Cursor as the start point by resetting the current GPS position (available in Advanced mode only).
[Continue]	On an active route, use cursor as destination with previous destination as via point (only available in Advanced mode).
[Save as POI]	Save Cursor as POI (only available in Advanced mode).
[Add to Favorites]	Saves the Cursor as a Favorite location.
[Save as Camera]	Save Cursor as Road Safety Camera location (only available in Advanced mode).
[Info]	Opens a screen with the name, address and coordinate information of the Cursor, and a list of nearby POIs.



■ Present location and route tracking

When your GPS position is available, Navigation marks your present position with the  icon on the map.

To use the current GPS position, touch [Position]. The Position menu appears and you can save the GPS position as one of the following:

- A Favorite
- A Road Safety Camera
- A POI
- A Map Marker Pin

■ Returning to normal Map screen

When GPS position is available, and you have moved the map (the  icon may have moved or be invisible), or you have rotated the map in 3D mode,  appears. Touch this switch to return the map to the GPS position and re-enable Track-up map orientation (automatic map rotation).

CAUTION

Even if you move the map while you are driving, Navigation continues navigating if there is an active route. It plays the voice instructions and displays the turn preview icons according to your current GPS position.

Navigation Overview

■ Position determination (Cursor)

If you select a location in the Find menu, or you touch the map when the map control switches are visible, the Cursor appears at the selected point on the map. Navigation displays the Cursor with a radiating red dot () to make it visible at all zoom levels, even when it is in the background of a 3D map view.

When the Cursor is set, touch [Cursor]. The Cursor menu appears and you can use the Cursor as one of the following:

- Start point of a route
- A via point in a route
- The destination of a route

You can also search for POIs around the Cursor.

Or you can save the location of the Cursor as:

- A Favorite
- A Road Safety Camera
- A POI
- A Map Marker Pin

■ Displaying original position in cursor menu

When the Cursor menu is open, a special icon () shows the Cursor position the menu was opened.

You can move and zoom the map, and reposition the Cursor. The usual Cursor () appears, and the switches of the Cursor menu initiate actions for this new location.

To return to the original Cursor position, tap . The map jumps back to the position it held when the Cursor menu was opened, and the  icon reappears.

■ Switching to desired scale

Smart Zoom provides much more than just a usual automatic zoom feature.

- **While following a route calculated by Navigation:** When you approach a junction, it will zoom in and raise the view angle to let you easily recognize your maneuver. If the next turn is at a distance, it will zoom out and lower the view angle to be flat so you can see the road in front of you.
- **While driving without an active route:** Smart Zoom will zoom in if you drive slowly and zoom out when you drive at high speed.

Enabling smart zoom

Touch the map to make the map control switches appear, and then touch  to enable Smart Zoom.

Fine-tuning Smart Zoom

Touch the map to make the map control switches appear, and then touch and hold  to open the Smart Zoom settings window. Modify the zoom limits of Smart Zoom as necessary.

■ Driving track display

This unit can log the track that you drive. (See page 103)

A Track Log is a record of the change in GPS position and is independent of the route calculated by this unit.

Track Logs can be recorded, renamed, swapped, shown on the map, exported to a memory card in GPX format, and deleted. (See page 103)

You can instruct this unit to record native GPS data received from the GPS device, independently of the normal Track Log. These logs are saved as separate text files on a memory card, and they cannot be shown or replayed in this unit.

To turn on NMEA/SIRF log saving, touch the following switches: [Menu], [Settings], [Track Logs], [Create NMEA/SIRF Log].

■ Using logs

This unit can record the track (change in GPS position) as you drive.

CHECK

There is no need to select a destination and create a route. Your path is recorded as you travel.

This feature is available in Advanced mode only.

The procedure is explained starting from the Map screen.

Navigation Overview

Recording the travelled path (creating a Track Log)

1 Start driving.

2 Touch the following switches: [Menu], [Settings], [Track Logs]

3 Start recording: Touch [Record].

- You can return to the map and continue driving.

4 Repeat the above steps, then touch [Stop Recording] to stop the recording.

- Navigation labels the Track Log with a time stamp.
(As an alternative, you can touch  in the Quick menu to start, and then again to stop the Track Log recording.)

Simulating a Track Log on the map

1 Touch the following switches: [Menu], [Settings], [Track Logs]

2 Locate the desired Track Log, and then touch  next to it.

3 The map returns, and the Track Log simulation (a life-like replay) begins.

4 You can stop the replay any time by touching [Stop].

Changing the color of a Track Log

1 Touch the following switches: [Menu], [Settings], [Track Logs]

2 Touch the desired Track Log and then touch one of the color switches.

■ Saving route

This feature is available in Advanced mode only.

The procedure is explained starting from the Map screen.

1 Touch the following switches: [Menu], [Route], [Save Route]

2 Enter a name for the saved route, and then touch [Done].

- When saving a route, Navigation saves not only points along the route, but the entire itinerary.
- The saved route might have been influenced by Traffic information. When a route is used at later date, it may seem to be the saved route. However, where necessary, current Traffic information is used to recalculate the new route.
- If you updated your map since you first saved the route, Navigation recognizes the change, and recalculates the driving instructions according to the latest available map information.
- During navigation, Navigation deletes via points that you already left behind together with the road segments used to reach it. If you wish to save the route, you need to do so before starting to navigate.

Navigation Overview

■ Loading saved route

This feature is available in Advanced mode only.

The procedure is explained starting from the Map screen.

- 1 Touch the following switches: [Menu], [Route], [Load Route]
- 2 Touch the route you wish to navigate.
- 3 In the very likely case that the start position of the saved route is different from the current GPS position, you need to confirm whether you want to stop navigating from the current GPS position to use the start point of the loaded route.
 - If you choose to keep the current GPS position as the start point, the route will be recalculated starting from your present position.
- 4 The map appears, and you can start navigating.

■ Map screen

Navigation is primarily intended for land navigation. That is why maps in Navigation look similar to paper road maps. However, Navigation provides much more than regular paper maps. You can customize the look and the content of the map. The most important and most often used screen of Navigation is the Map screen.



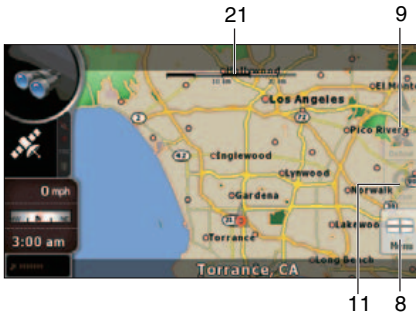
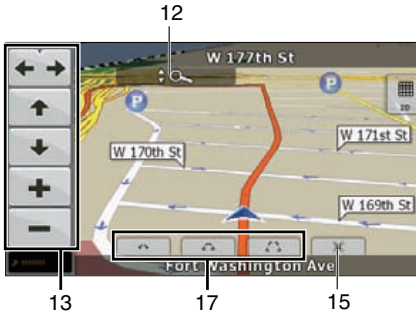

Navigation Overview



20

During navigation, the screen shows route information and trip data (left screens), but when you tap the map, additional switches and controls appear for a few seconds (right screenshot). Most parts of the screen behave as switches.

Symbol	Name	Action
1	Main information. Ex) Next route event.	Opens the Route Information screen.
2	Second upcoming route event	Opens the Itinerary.
3	Trip information screen	Opens the Trip information screen.
4	GPS position quality	Opens the Quick menu
5	Next street	n/a
Top row		
6	Current street and house numbers on left and right	n/a
Bottom row		
7	Map view modes	Switches between 2D, 3D and North up mode.
8	Menu	Opens the Navigation menu.
9	Detour	Opens the Detour screen. There are two ways to modify your route. <ul style="list-style-type: none"> ● The list of saved Search Criteria ● A switch to avoid parts of the route
10	Position menu (appears when navigating a route)	Opens the Position menu.
11	Cursor menu (appears when there is no GPS position or the Cursor is not at the current GPS position)	Opens the Cursor menu
12	Opens/closes the map control switches (touch this switch to display/hide the following map control switches).	<ul style="list-style-type: none"> ● Zoom in/out ● Rotate left/right (3D map only) ● Tilt up/down (3D map only) ● Zoom preset switches (2D map only) ● Tilt and zoom preset switches (3D map only) ● Return to GPS position switch ● Smart Zoom
13	Rotate left, rotate right	Rotates the 3D map left or right
	Tilt up, tilt down	Tilts the 3D map
	Zoom in, zoom out	Scales the map

Symbol	Name	Action
14	Return to GPS position (appears when GPS position is available and you have moved the map)	Touch this switch to move the map back to the current GPS position. If the map has been rotated in 3D mode, automatic map rotation is also re-enabled.
15	Enable Smart Zoom (replaces the Previous switch when there is no GPS position or the map has not been moved).	<u>Touch this switch once to enable Smart Zoom.</u> <u>Touch and hold this switch once to set the zoom limit on Smart Zoom.</u>
16	Zoom preset switch (available in Advanced mode only).	<u>Touch the preset switch once</u> to set the zoom level to a fixed predetermined value. Smart Zoom is disabled. These switches are available in 2D mode. <u>Touch and hold the desired switch</u> to set the zoom value as the current zoom level, or reset to an original value.
17	Tilt preset switch (available in Advanced mode only).	<u>Touch one of the preset switches</u> to set the tilt and zoom level to fixed predetermined values. Smart Zoom is disabled. These switches are available in 3D mode. <u>Touch and hold the desired switch</u> to set the tilt and zoom level to the desired values or reset them to their original values.
18	Current GPS position (on nearest road)	n/a
19	Cursor (selected map location)	n/a
20	Lane information	n/a
20 Orange line	Active route	n/a
21	Map scale (2D map only)	n/a

Navigation Overview

■ About roads

Navigation shows the streets in a similar way to paper road maps.

Their width and colors correspond to their importance. You can easily tell a freeway from a small street.

CHECK

If you prefer not to see street names during navigation, turn them off (See page 52).

■ 3D Object types

To enable and disable 3D pictures, touch the following switches: [Menu], [Settings], [Map Screen], [3D settings]





Navigation supports the following 3D object types:

Type	Description
3D landmarks	Landmarks are 3D artistic or block representations of prominent or well-known objects. 3D landmarks are only available in selected cities and countries.
Elevated roads	Complex intersections and vertically isolated roads (such as overpasses or underground tunnels) are displayed in 3D.
3D buildings	Full 3D city building data that represents actual building size and position on the map. Building data is limited to the city centers of major cities in the US and Europe.
3D terrain	3D terrain map data shows changes in terrain, elevations or depressions in the land when you view the map, and use it to plot the route map in 3D when you navigate.

■ Managing facilities information

You can manage your POIs, and set POI visibility for both your own POIs and the ones that came with the product. Touch the following switches: [Menu], [Manage], [POI]



Touch switch/icon	Description
Switch including name of POI group	Opens the list of the subgroups of this POI group. The new list behaves in the same way.
Switch including the name and address of a POI item	Opens the selected POI for editing. Only the POIs you have created appear in this list.
[Edit]	Opens the selected POI group for editing.
[My POI]	Touch to filter the list to contain only the POIs that you saved.
[All]	Touch to see all POIs in the list.
[New Group]	Creates a new POI group at the given group level.
	Turns the page for a view of new list items.

Touch switch/icon	Description
	This POI group is not shown on the map.
	This POI group and all its subgroups are shown on the map.
	This POI group and some of its subgroups are shown on the map.
	This POI group contains POIs that you saved.

When a POI group is open for editing:

Touch switch	Description
[Off]	Items in the POI group will not be shown on the map.
[Close], [Medium], [Far Ahead], [Satellite]	The distance switches set the zoom level at which to show the items in the POI group on the map.
[Same Visibility in Subgroups]	Subgroups under the edited POI group will inherit the visibility settings of the POI group.
Switch including icon of POI group	Touch this switch to select a new icon for the POI group.
[Rename]	Rename edited POI groups.
[Remove]	Delete edited POI groups. Created POI groups can only be deleted.

When a POI item is open for editing:

Touch switch	Description
Switch including name of POI group	Touch this switch to rename the POI.
Switch including POI icon	Touch this switch to select a new icon for the POI.
	Touch this switch to enter a telephone number for the POI.
	Touch this switch to enter additional information for the POI.
[Delete]	Touch this switch to delete the selected POI.
[Change Group]	Touch this switch to move the POI to another POI group or subgroup.

Navigation Overview

■ Itinerary display

The Itinerary is a list of the route events, which are the driving instructions.





On the Map screen you can display itineraries by the following methods.

- Touch the area between the Turn preview field where the next maneuver is shown and the Travel data field.
- In the Advanced mode, touch the following switches: [Menu], [Route], [Itinerary]

You have the following options on the Itinerary screen:

Touch switch	Description
Any of the list items	Opens the map with the selected maneuver in the middle.
[Mode]	Changes the detail level of the Itinerary. The levels are as follows: <ul style="list-style-type: none"> ● Detailed Instructions: All intersections are listed ● Itinerary: Only significant intersections (the ones announced in voice guidance) are listed ● Roads list: The list of the roads used while navigating the route.
	Moves between pages for additional list items.

When the map is open with a maneuver in the middle:

Touch switch	Description
	Zooms in the map.
	Zooms out the map.
	Moves the map to show the previous or next maneuver.
[Avoid.]	Opens a screen from which you can avoid a part of the route starting from a selected maneuver.



■ Route editing

This feature is available in Advanced mode only.

Touch the following switches: [Menu], [Route], [Edit Route]

A list of route points appears with the start point at the top of the list and the final destination at the bottom. If several via points exist, you might need to scroll between pages.

Touch one of the route points in the list. You have the following options:

Touch switch	Description
	The selected point moves up in the list (becomes a via point to be reached earlier). Repeatedly touching this switch will make this point the start point.
	The selected point moves down in the list (becomes a via point to be reached later). Repeatedly touching this switch will make this point the final destination.
	Reverses the route. The start point becomes the destination, the destination becomes the start point, and the order of the via points is reversed.
[Optimize]	The route is optimized. The start point and the destination remain in position, but the via points are reordered to make the shortest possible route.
[Remove]	Touch this switch to remove the selected point from the route.

As soon as you leave this screen, the route is recalculated automatically, and you can start navigating right away.

■ Route information screen

The Route information screen has all the data and some of the functions you need while you navigate. There are two ways to open this screen:

- Touch the Turn Preview field () to open directly from the Map screen.
- In the Advanced mode, touch the following switches from the Navigation menu: [Route], [Route Info]



In the top section of the screen you see information about the current route. The fields on this screen are continuously updated while the screen is open.

When you open the screen, all fields contain information about reaching your final destination.

Navigation Overview

Touch any of the fields to see data on the via points starting from the first one through the final destination.

This screen includes following data and features:

Name	Description	Function
Route Line	The upper part of this screen shows your planned route as a horizontal line. The point at the left end represents the route starting point and the point at the right end represents the final destination. The flags of the via points along the line are separated by intervals proportional to the distances between them.	Touch this field to change the content of all data fields to via point information.
Estimated Arrival	Shows the estimated arrival time at the final destination of the route based on information available for the remaining segments of the route. The calculation cannot take into account traffic jams and other possible delays.	Touch this field to change the content of all data fields to via point information.
Distance Left	Shows distance left to final destination.	Touch this field to change the content of all data fields to via point information.
Time Left	Shows the time needed to reach the final destination of the route based on information available for the remaining segments of the route. The calculation cannot take into account traffic jams and other possible delays.	Touch this field to change the content of all data fields to via point information.
Method	This field shows how the route was calculated. The route type (fast, short, simple, or economical) is displayed here.	Touch this field to change the content of all data fields to via point information.
Warning icons	In these square fields graphical symbols are displayed in the case that warnings are attached to the planned route. These are warnings, so icons always show information for the whole route, even if the data fields only display values from your present position to a via point.	Touch any of the icons for an explanation.
[Settings]		Opens the Route planning options screen from the Settings menu.
[Plan on Map]		Opens the Map screen designed for route planning.
[Skip Next Via]	Appears only if at least one via point exists.	Deletes the next via point from the route.
[Delete Route]	Only appears when the route contains no via points.	Deletes the active route.

■ Facility information, storage, and revision

A point of interest (POI) is a location that someone might find useful or interesting. Navigation comes with several thousand POIs included. You can create POIs independently in the application.

POI locations are marked on the map with special icons. POI icons are quite large so you can easily recognize the symbol. The icons are semi-transparent. They do not hide the streets and intersections behind them.

POIs are grouped into several levels of categories and subcategories. The icon of POIs that come with the map shows the symbol of the POI category. If you save your own POI, you can select an icon for it independently of the POI category you have put it in.

Saving POIs



To save a POI, place the Cursor () at the desired location, then touch the following switches: [Cursor], [More Options], [Save as POI]

Managing POIs

You can select which POI groups to show and which ones to hide on the map, and from which zoom levels POI icons are visible. At the same place, you can manage your saved POIs. A saved POI can be renamed, moved to a different POI group, its icon can be changed, or a phone number and additional information can be added to it. Touch the following switches: [Menu], [Manage], [POI]

■ Managing saved search criteria

You can manage the list of previously saved search criteria to easily find frequently searched POI types. Touch the following switches: [Menu], [Manage], [Saved Search Criteria]

Touch switch	Description
Switch with the name of the Saved Search Criteria	Touch to rename the saved query.
	Deletes the selected item in the list.
[Clear All]	Deletes the entire list.
	Turns the page for view of other list items.
[<Add new search>]	Touch to save new search criteria. In the same way as you search for POIs, first select the search reference, then select the POI group or subgroup to search in.

Navigation Overview

Using Keyboard Screen

You only need to enter letters or numbers in Navigation when you cannot avoid it. You can type with your fingertips on the full-screen keyboards and you can switch between various keyboard layouts, for example ABC, QWERTY, or numerical.

Task	Description
Switching to another keyboard layout, for example from an English QWERTY keyboard to a Greek character keyboard	Touch [US ENGLISH (QWERTY)] to select it from the list of available keyboard types. Navigation remembers your last keyboard choice and offers it the next time you need to enter data.
Correcting an entry on the keyboard	Delete an unwanted character: Touch  . Touch and hold the switch to delete the entire string.
Entering a space, for example between a first name and a family name or in multi-word street names	Touch [Space].
Entering lowercase or capital letters	Touch [aA] to cycle through entering lowercase letters, initial capitals and all capitals.
Entering symbols	Tap [@/!] to switch to a keyboard offering symbol characters.
Finalizing the keyboard entry	Touch [Done].

Navigation Guidance

You can set up your route in Navigation in several ways:

- if you need a simple route (a route with only one destination and without any intermediate via points), you can select the destination and start navigating to it right away.
- You can plan a multi-point route (available in Advanced mode only).
- You can also plan a route independently of your current GPS position or even without GPS reception (available in Advanced mode only)

Destination Setting

Navigation offers you several ways of choosing your destination and via points (intermediate destinations).

- Use selected location (Cursor) on the Map (See page 89).
- Enter an address or part of an address. For example, enter a street name rather than a house number or the names of two intersecting streets (See page 90).
- Enter an address with ZIP code (See page 95). In this case, there is not need to select a city name. This will speed up the search for a street name.
- Use coordinates (See page 98)
- A Favorite (See page 96)
- A POI (See page 96)
- From a history of set destinations and intermediate points (See page 98)

CHECK

If you are going to use a route later, save it before you start navigating. Touch the following switches: [Menu], [Route], [Save Route]

Setting from Map Scroll

- 1 Locate your destination on the map. Move and scale the map as needed (See page 66).
- 2 Touch the location that you want to select as your destination. The Cursor  appears.
- 3 Touch [Cursor] to open the Cursor menu.
- 4 The map appears with the selected point in the middle. From the Cursor menu, touch [Set as Destination] (Advanced mode). The route is then automatically calculated, and you can start navigating.

ATTENTION

When you wish to use the destination later, save it as a POI from the Cursor menu and then add it to your list of Favorites.

The Cursor menu returns automatically with the same point. Now you can use it as a route point.

Navigation Guidance

Setting from Address

If you know at least a part of the address, this is the quickest way to select the destination of the route.

Using the same screen, you can find an address by entering:

- The exact address, including house number
- A city center
- An intersection
- The midpoint of a street
- Any of the above, starting the search with the ZIP code (See page 95)

■ Entering Address

In some countries, a state name may be included in the address. If any of these countries or a country from the list of country names is selected, 5 lines appear on the screen.



- 1 Touch the following switches: [Find Address] (Advanced mode)

- 2 By default, Navigation proposes the country/state and city where you are. If needed, touch the switch with the name of the country on it, and select a different one from the list. When selecting a new country, you need to either select a state or, to search for a city regardless of your current state, touch [<All states>].

- 3 Even when you do not change countries, you may change state. Touch the state name switch, and select from the list.

- 4 If needed, change the city.

- To select the city from the list of recently used ones, touch the  switch.

- 5 Touch the following switches. After changing the country/state, touch [<City Name>].

- Start entering the city name on the key board.
- After entering a couple of characters, the names that match the string appear in a list.
- Touch [Done] to open a list of results before one appears automatically.

- 6 Pick the city from the list.

7 Touch [<Street Name>].

- Start entering the street name on the keyboard.
- After entering a couple of characters, the names that match the string appear in a list.
- Touch [Done] to open a list of results before one appears automatically.

8 Select the street from the list.

9 Touch [<House Number>].

- Enter the house number on the keyboard.

10 Touch [Done] to finish entering the address.

11 The map appears with the selected point in the middle. From the Cursor menu, touch [Set as Destination] (Advanced mode). The route is then automatically calculated, and you can start navigating.

■ Entering addresses for repeating house number allocation

On some long roads house numbering is restarted at some point. Hence, the same house number can appear twice or even more times on the same road. If this is the case, after entering the house number, you need to select the appropriate address by the district/suburb information.

1 Touch the following switches: [Find], [Find Address] (Advanced mode).

2 By default, Navigation proposes the country/state and city where you are. If needed, touch the switch with the name of the country/state, and select a different one from the list.

3 If needed, change the city.

- To select the city from the list of recently used ones, touch the  switch.

4 Touch the following switches. After changing the country/state, touch [<City Name>].

- Start entering the city name on the keyboard.
- After entering a couple of characters, the names that match the string appear in a list.
- Touch [Done] to open a list of results before one appears automatically.

5 Pick the city from the list.

Navigation Guidance

6 Touch [<Street Name>].

- Start entering the street name on the keyboard.
- After entering a couple of characters, the names that match the string appear in a list.
- Touch [Done] to open a list of results before one appears automatically.

7 Select the street from the list.

8 Touch [<House Number>].

- Enter the house number on the keyboard.

9 Touch [Done] to finish entering the address.

10 A list appears with the matching addresses. Touch the desired one.

11 The map appears with the selected point in the middle. From the Cursor menu, touch [Set as Destination] (Advanced mode). The route is then automatically calculated, and you can start navigating.

■ Entering address without knowing district or suburb

Long roads can run across several districts or suburbs. You may not know what particular house number is located where. In this case, follow the instructions below.

1 Touch the following switches: [Find], [Find Address] (Advanced mode).

2 By default, Navigation proposes the country/state and city where you are. If needed, touch the switch with the name of the country/state, and select a different one from the list.

3 If needed, change the city.

- To select the city from the list of recently used ones, touch the  switch.

4 Touch the following switches. After changing the country/state, touch [<City Name>].

- Start entering the city name on the keyboard.
- After entering a couple of characters, the names that match the string appear in a list.
- Touch [Done] to open a list of results before one appears automatically.

5 Pick the city from the list.

6 Touch [<Street Name>].

- Start entering the street name on the keyboard.
- After entering a couple of characters, the names that match the string appear in a list.
- Touch [Done] to open a list of results before one appears automatically.

7 Instead of selecting one of the streets, touch [Search in All].

8 Touch [<House Number>].

- Enter the house number on the keyboard.

9 Touch [Done] to finish entering the address.

10 A list appears with the matching addresses. Touch the desired one.

11 The map appears with the selected point in the middle. From the Cursor menu, touch [Set as Destination] (Advanced mode). The route is then automatically calculated, and you can start navigating.

■ Selecting from intersection

1 Touch the following switches: [Find], [Find Address] (Advanced mode).

2 By default, Navigation proposes the country/state and city where you are. If needed, touch the switch with the name of the country/state, and select a different one from the list.

3 If needed, change the city.

- To select the city from the list of recently used ones, touch the  switch.

4 Touch the following switches. After changing the country/state, touch [<City Name>].

- Start entering the city name on the keyboard.
- After entering a couple of characters, the names that match the string appear in a list.
- Touch [Done] to open a list of results before one appears automatically.

5 Pick the city from the list.

Navigation Guidance

6 Touch [<Street Name>].

- Start entering the street name on the keyboard.
- After entering a couple of characters, the names that match the string appear in a list.
- Touch [Done] to open a list of results before one appears automatically.

7 Select the street from the list.

8 Touch [Intersection].

- If only a few intersecting streets exist, a list of them appears immediately.
- For longer streets, a keyboard screen appears. Start entering the name of the intersecting street on the keyboard. As you type, if the matching streets can be shown on one screen, a list of them appears automatically.

9 Touch the desired intersecting street in the list.

10 The map appears with the selected point in the middle. From the Cursor menu, touch [Set as Destination] (Advanced mode). The route is then automatically calculated, and you can start navigating.

■ Selecting from city center

The City Center is not the geometric center of the city but an arbitrary point the map creators have chosen. In towns and villages, it is usually chosen to be the most important intersection. In large cities, it is an important intersection.

1 Touch the following switches: [Find], [Find Address] (Advanced mode).

2 By default, Navigation proposes the country/state and city where you are. If needed, touch the switch with the name of the country/state, and select a different one from the list.

3 If needed, change the city.

- To select the city from the list of recently used ones, touch the  switch.

4 Touch the following switches. After changing the country/state, touch [<City Name>].

- Start entering the city name on the keyboard.
- After entering a couple of characters, the names that match the string appear in a list.
- Touch [Done] to open a list of results before one appears automatically.

5 Pick the city from the list.

6 Touch [City Center].

7 The map appears with the selected point in the middle. From the Cursor menu, touch [Set as Destination] (Advanced mode). The route is then automatically calculated, and you can start navigating.

■ Selecting from ZIP code

All of the above address searching possibilities can be performed when entering the ZIP code instead of the city name. The following is an example for a full address.

1 Touch the following switches: [Find], [Find Address] (Advanced mode).

2 By default, Navigation proposes the country/state and city where you are. If needed, touch the switch with the name of the country/state, and select a different one from the list.

3 Touch the City Name switch, and enter the ZIP code.

- Start entering the ZIP code on the keyboard.
- After entering a couple of numbers, matching city names appear in a list.
- Touch [Done] to open a list of results before one appears automatically.

4 Pick the city from the list.

5 Touch [<Street Name>].

- Start entering the street name on the keyboard.
- After entering a couple of characters, the names that match the string appear in a list.
- Touch [Done] to open a list of results before one appears automatically.

6 Select the street from the list.

7 Touch [<House Number>].

- Enter the house number on the keyboard.

8 Touch [Done] to finish entering the address.

9 The map appears with the selected point in the middle. From the Cursor menu, touch [Set as Destination] (Advanced mode). The route is then automatically calculated, and you can start navigating.

Navigation Guidance

■ Entering quick address

- When you are entering the name of a city or a street, Navigation only displays those characters that appear in possible search results. The other characters are grayed out.
- To enter a city or street name, enter a few letters and then touch [Done]. Navigation will display a list including the entered letters.
- You can speed up finding an intersection.
- Search for the rare or less common name first. A few letters should be sufficient.
- If one of the streets is shorter, search for that one first. You can then find the second one faster.
- You can search using both the type and the name of the roads. If the same word appears in several names, for example in the name of streets, roads and avenues, you can obtain the result faster if you enter the first letter of the street type. For example, enter Pi A to obtain Pine Avenue and skip all Pine Streets and Pickwick Roads.
- You can also search in ZIP codes. This is useful when a street name is common and it is used in several districts of a city.

Setting from Favorites

You can select a location that you have already saved as a Favorite to be your destination.

- 1 Touch the following switches: [Find], [Favorites] (Advanced mode).
- 2 Touch the Favorite you wish to set as your destination.
- 3 The map appears with the selected point in the middle. From the Cursor menu, touch [Set as Destination] (Advanced mode). The route is then automatically calculated, and you can start navigating.

Setting from Facility Information

■ Selecting from facility information

You can select your destination from the POIs included with Navigation or from the ones you have previously created.

- 1 Touch the following switches: [Find], [Find POI] (Advanced mode).

2 Select the area in which to search for the POI.

- [Around Address]: The POI will be searched for around a given address.
- [Around Cursor]: The map appears with the Cursor in the middle. Modify the location of the Cursor if necessary, then touch [OK]. The POI will be searched for around the given location.
- [Around GPS Position]: The POI will be searched for around the current GPS position.
- [Around Destination]: The POI will be searched for around the destination of the active route.
- [Along Route]: The POI will be searched for not around a given point, but by the size of the detour it adds to the active route. This is useful when searching for stop offs which can be reached with a minimal detour. Examples of such stop offs include restaurants and gasoline stands.

3 You can narrow the search with the following:

- Select the POI group (e.g. Accommodation), and after that, if needed, select the POI subgroup (e.g. Hotel or Motel).
- To find the POI by its name, touch [Search] , and use the keyboard to enter a part of the name.
- To list all POIs in a given group, touch [List All in this Group].

4 When the list of results appears, you can sort the list.

- [Order by Name]: Sort the list alphabetically (available when you search around a single location).
- [Order by Distance]: Sort the list by the straight-line distance from your present position (available when you search around a single location).
- [Order by Distance]: Sort the list by the distance to drive on the route from your present position (available when you search along the active route).
- [Order by Detour]: Sort the list by the size of the needed detour (available when you search along the active route).

5 Touch the desired POI in the list.

6 Touch [Select].

7 The map appears with the selected point in the middle. From the Cursor menu, touch [Set as Destination] (Advanced mode). The route is then automatically calculated, and you can start navigating.

Navigation Guidance

Select from saved facility information search criteria

You can save POI search criteria in the POI section of the Manage menu. However, Navigation also comes with a number of pre-saved criteria which can be used immediately to search for POIs.

- 1 Touch the following switches: [Find], [Find POI] (Advanced mode).
- 2 Touch [Saved Search Criteria].
- 3 Select one of the saved criteria, and a list of matching POIs appears.
- 4 Touch the desired POI in the list.
- 5 The map appears with the selected point in the middle. From the Cursor menu, touch [Set as Destination] (Advanced mode). The route is then automatically calculated, and you can start navigating.

Setting from History

Past destinations appear in the History.

- 1 Touch the following switches: [Find], [History] (Advanced mode).
- 2 If necessary, move between pages with  to see past destinations.
- 3 Touch the desired item.

- 4 The map appears with the selected point in the middle. From the Cursor menu, touch [Set as Destination] (Advanced mode). The route is then automatically calculated, and you can start navigating.

Setting from Coordinates

This feature is available in Advanced mode only.

- 1 Touch the following switches: [Find], [Find Coordinate]
 - Touch [Coordinate Display Format] to change the format of the displayed coordinates.
- 2 Touch longitude or latitude values to change the coordinates.
- 3 Enter the coordinate values in the WGS84 format: The latitude (N or S) and the longitude (E or W).
- 4 Touch [Done].
- 5 Touch [OK].

- 6 The map appears with the selected point in the middle. From the Cursor menu, touch [Set as Destination] (Advanced mode). The route is then automatically calculated, and you can start navigating.

Search Menu

Select the route destination. Touch the following switches: [Menu], [Find]

Touch switch	Description	Reference
[Find Address]	If you know at least a part of the address, this is the quickest way to find the location.	90
[Find POI]	You can select your destination from the thousands of POIs included with Navigation or from the ones you have previously created.	96
[History]	The destinations that you have already entered in Navigation are available in the History list.	98
[Find Coordinate]	You can select your destination by entering its coordinates.	98
[Favorites]	You can select a location already saved as a Favorite to be your destination.	96
[Plan on Map]	Opens a special 2D Map screen optimized for route planning. The Zoom in, Zoom out and route modifying switches of the Cursor menu appear.	99

■ Display route (in accordance with screen)

The map can be moved and scaled to show the whole line of the route. You do not need to manipulate the map manually. The Plan on Map feature does it for you.

In Advanced mode, the following options are available on Plan on Map.

- From the Find menu: Touch [Menu], [Find], [Plan on Map].
- From the Route information screen: Touch [Menu], [Route], [Route Info], [Plan on Map].
- From the Route Information screen using a shortcut: Touch , [Plan on Map].

■ Traffic

This unit can provide you with even better Routes, if Traffic Message information is available.

If public Traffic data is broadcast at your location, this unit automatically takes into account the Traffic data received. You do not need to set anything in the program. The decoded information will immediately be used in route planning. The moment unit receives traffic information that may affect your route, the program will warn you that it is recalculating the route, and this unit will continue with a new route that is optimal based on the most up-to-date traffic conditions.

Touch the following switches: [Menu], [Settings], [Traffic INFO]

Navigation Guidance

Route Search and Advanced Search

Navigation calculates the route based on your preferences.

Route calculation methods

- Fast
- Short
- Economical
- Easy

Road types

- Unpaved roads
- Permit needed
- Freeways
- Toll roads
- Charge roads
- Ferries
- Cross-border planning
- Carpool (appears only when used in the USA)

This unit automatically recalculates the route if you deviate from the proposed itinerary.

Depending on the type of the Traffic event, This unit also recalculates the route if a Traffic event concerns a part of the recommended route.

For further information about Route Planning options, see "Route planning option" on page 53.

■ Creating multiple destinations (adding intermediate points)

A multi-point route is created from a simple route. Hence, the route must be non-active at first. One of the ways of expanding the route is to keep the destination, and to add via points (intermediate destinations).

This feature is available in Advanced mode only.

1

Select a new location as you did in the previous sections. The new location is added within the route.

2

The map appears with the selected point in the middle. Then the Cursor menu opens automatically.



3

Touch [Insert as Via] to add location as intermediate destination before the final destination on the route.

- To add more points to the route, repeat the above steps as many times as you like.

When you insert via points in a routes which already includes multiple points, the Edit route screen appears automatically. From this screen, you can decide the positions of the intermediate route points. When you enter the screen, the new via point is places as the last via point before the final destination. The new point is the highlighted point in the list.

You have the following options:

Touch switch	Action
	The selected point moves up in the list (becomes a via point to be reached earlier). Repeatedly touching this switch will make this point the start point.
	The selected point moves down in the list (becomes a via point to be reached later). Repeatedly touching this switch will make this point the final destination.
	Reverses the route. The start point becomes the destination, the destination becomes the start point, and the order of the via points is reversed.
[Optimize]	The route is optimized. The start point and the destination remain in position, but the via points are reordered to make the shortest possible route.
[Remove]	Touch this switch to remove the selected point from the route. The route remains as it was before adding the new point.

Every time a new point is added, the route is recalculated automatically and you can start navigating right away.

■ Creating multiple destinations (adding new destination)

A multi-point route is created from a simple route. Hence, the route must be non-active at first. Another way of expanding the route is to add a new destination. The previous destination becomes the last via point of the route.

This feature is available in Advanced mode only.

- 1** Select a new location as you did in the previous sections. The new location is added to the route as a destination.
- 2** The map appears with the selected point in the middle. Then the Cursor menu opens automatically.
- 3** Touch [More Options] to open the full Cursor menu with the additional functions.
- 4** Touch [Continue] to add the point as a new final destination demoting the previous one to the last intermediate destination.

- To add more points to the route, repeat the above steps as many times as you like.

Every time a new point is added, the route is recalculated automatically and you can start navigating right away.

Navigation Guidance

■ Deleting an intermediate point from the route

The simplest way to delete the next route point (next via point) is to touch the Turn Preview field () of the Map screen, then touch [Skip Next Via] to open the Route information screen.

In Advanced mode, you have another option. Touch the following switches: [Menu], [Route], [Route Info], [Skip Next Via].

■ Detour menu

This screen contains quick detour possibilities during navigation. You can touch [Detour] directly from the Map screen.



The options are as follows.

- On the main part of the screen you can see the first page of Saved Search Criteria. Select any of the criteria to quickly receive the list of nearest matching POIs, and instantly plan a new route to the desired one, or insert it as a via point in your active route.
- In Advanced mode more switches appear at the bottom.
- [Avoid]: If you want to bypass a part of the route starting from the next intersection, touch this switch, and select a distance to bypass.
- [Delete Avoids]: If you have used the above function, touch this switch to clear the restrictions from the map.

About Destination History

■ Managing history

You can manage the list of recently used locations. Touch the following switches: [Menu], [Manage], [History]

Touch switch	Description
	Deletes the selected item in the History.
[Clear History]	Deletes entire history.
 	Turn the page to view further items on the list.

Deleting Destination History

■ Deleting active route

The simplest way to delete an active route is to touch the Turn Preview field () of the Map screen, then touch [Delete Route] to open the Route information screen.



In Advanced mode, you have another option. Touch the following switches: [Menu], [Route], [Delete Route]

CAUTION

If via points exist in the active route, you cannot delete the route immediately on the Route information screen. When you repeatedly touch [Skip Next Via] until all the via points have disappeared, [Delete Route] will appear. Touch this switch to cancel the whole route.



■ Managing saved routes

You can manage previously saved routes. Touch the following switches: [Menu], [Manage], [Saved Routes]



Touch switch	Description
Switch with name of saved route	Opens the selected route for editing.
	Deletes the selected route.
[Clear All]	Clears the list of saved routes.
	Turn the page to view further items on the list.

■ Managing Track Logs

You can record Track Logs, then play them back, display them on the map, and view their details. Touch the following switches: [Menu], [Manage], [Track Logs].

Touch switch	Description
[Record]	Starts recording the track that you drive. (You can also start recording a Track Log in the Quick menu.)
[Stop Recording]	Stops the ongoing Track Log recording. (You can also start recording a Track Log in the Quick menu.)
Switch with the name of the Track Log	Shows the details of the selected Track Log.
	Starts a simulated playback of the selected Track Log on the map.
	Turns the page to view further items on the list.

When Track Log details are shown:

Touch switch	Description
Switch with the name of the Track Log	Opens a Keyboard screen to let you rename the Track Log.
	Touch this switch to hide the Track Log on the map. No color will be assigned to the Track Log.
	Touch one of the colored switches to assign a color to the Track Log. The Track Log will be shown on the map in this color.
[Fit to screen]	The map returns with the Track Log. The map is scaled to show the whole Track Log.
[Delete]	Deletes the selected Track Log.
[Export]	Saves the Track Log on the inserted memory card in GPX format.

Navigation Guidance

Demonstration (Demo)

A simulation drives you through the route, following the driving instructions (page). You can choose between a simulation at high speed or at normal driving speed.

For example, using route demonstration, you can check the bridges planned by Navigation. You can then avoid any bridges you do not wish to cross.

■ Viewing a route demonstration

This feature is available in Advanced mode only.



The procedure is explained starting from the Map screen.

- 1** Touch the following switches: [Menu], [Route]
- 2** The Route menu appears. There are two ways of running the route simulation.
 - Touch [Fly Over] to run the simulation at high speed to give you a quick overview of the route.
 - Touch [Simulate] to run the simulation at normal speed and with voice guidance instructions announced. This option is for demonstration purposes, or for checking difficult parts of the route in advance.
- 3** You can stop the simulation by pressing stop at any time [Stop].

Storing Locations

Managing Favorites

You can manage the list of your Favorites. Touch the following switches: [Menu], [Manage], [Favorites]







Touch switch	Description
Switch with name of Favorite	Opens the selected Favorite for editing.
	Deletes the selected item from the list of Favorites.
[Clear All]	Clears the list of Favorites.
	Turns the page for view other items on the list.

What to Do When...

About GPS Satellite Quality and Status

Touch  and the GPS switch to open the GPS Data screen and check the GPS reception status.



Icon	Color	Name	Description
	Green	GPS position quality indicator	Navigation is connected to the GPS receiver and able to obtain GPS position information in 3D. Navigation can calculate both your horizontal and vertical GPS position.
	Yellow		Navigation is connected to the GPS receiver and able to obtain GPS position information in 2D. Only the horizontal position is calculated, Navigation cannot calculate your vertical GPS position.
	Gray		Navigation is connected to the GPS receiver but cannot obtain GPS position information.
	Red		Navigation has no connection to the GPS receiver.
	Green (blinking)	GPS connection quality indicator	Navigation is connected to the GPS receiver.
	Yellow (blinking)		Navigation has no connection to the GPS receiver but it is still trying to establish a connection.
	Red (blinking)		Navigation has no connection to the GPS receiver and is not trying to establish a connection.
Sky blue circle			The virtual sky shows the visible part of the sky above you, with your position as the center. The satellites are shown at their current positions. The GPS receives data from both the green and yellow satellites. Signals from the yellow satellites are only received, while green ones are used by the GPS receiver to calculate your present location.

Icon	Color	Name	Description
n/a		Coordinates	Your current GPS position in WGS84 format.
n/a		Status bars for the satellites	Dark bars are for the yellow and lit bars are for the green satellites. The more satellites your GPS tracks (the green ones), the better is your calculated position.

About Speed Warnings

Maps may contain information about the speed limits of the road segments. This information may not be available in your district (ask your local dealer). Also, this information may not be completely accurate for all roads on the map.

You can configure Navigation to warn you if you exceed the current limit. Touch the following switches. [Menu], [Settings], [Warnings],[Warn When Speeding]. When you exceed the speed limit, the following will occur.

- Visible warning: A symbol with the speed limit appears in the corner of the map (For example: .
- Audible warning: A voice message is played using the selected guidance profile.

About Road Safety Cameras

The location of a Road Safety Camera is a special POI. These cannot be searched like other POIs, and there is a special proximity warning for cameras.

Is this device shipped with a built-in database of Road Safety Cameras?	No
Can you save the Cursor as the location of a Road Safety Camera?	Yes

■ Saving road safety cameras



To save a Road Safety Camera location, place the Cursor () at the desired location, then touch the following switches: [Cursor], [More Options], [Save as Camera]

What to Do When...

■ Camera warning



The warning for Road Safety Cameras can be turned on in Warning Settings. Touch the following switches: [Menu], [Settings], [Warnings], [Speed Camera Warning]



When you approach a Road Safety Camera with the warning enabled, the following happens.

- **Visible Warning:** The type of the camera is displayed in the secondary Turn Preview field (for example ).
- **Audible Warning:** When no speed limit specified for the camera, or your speed is under the specified speed limit, single beeps warn you about the camera.
- If you exceed the speed limit of the camera, the following also happens.
- **Visible warning:** A symbol with the speed limit appears in the corner of the map (for example: .
- **Audible warning:** A special alert sound is played.

■ Road Safety Camera types





There are different types of Road Safety Cameras.

Symbol	Type	Description
	Fixed	Some speed cameras stand by the roadside, looking in one direction, measuring traffic in one or both directions. They measure your current speed. For these speed cameras you can specify the controlled traffic direction and the speed limit. Navigation warns you when you approach these speed cameras in the measured direction. If your speed exceeds the speed limit near the speed camera, Navigation plays a special warning sound.
	Mobile	Some speed cameras are operated from vehicles. They are not constantly in operation and are not set to check a preset speed limit. The warning is similar to fixed speed cameras, but as there is no speed limit given, only the proximity is announced.
	Built-in	Some speed cameras are built into traffic lights. They work like fixed speed cameras, but they are difficult to spot. The warning for proximity and speeding is the same as for the fixed speed cameras.

Symbol	Type	Description
	Section control	<p>These speed cameras work in pairs, and do not measure your current speed but your average speed between the two speed cameras. Both identify your car and record the exact time you pass them. They use the difference between the two points in time to calculate your average speed.</p> <p>Navigation warns you when you approach these speed cameras in the measured direction. The warning continues as you pass the camera and your average speed up to the other of the two cameras is measured. If your average speed exceeds the speed limit between the two speed cameras, you receive the same special warning sound as with the other speed camera types.</p> <p>In the rare case Navigation cannot register the moment you pass the second speed camera (for example, it is placed at the exit of a tunnel where GPS positioning is not yet available) the warning continues. Touch the speed camera symbol displayed on the screen to stop the warning.</p>
	Red light	<p>These cameras check whether traffic lights are being obeyed. The warning is similar to mobile speed cameras. As there is no associated speed limit, only the proximity is announced.</p>

■ Road Safety Camera directions

A speed camera can measure the speed of one direction of the traffic, both directions, or even several directions at an intersection when mounted on a rotating base. Red light cameras measure traffic in the same direction. Navigation warns you only if you are driving in a measured or possibly measured direction. The measured direction of the camera appears with the following symbols.

Symbol	Description
	The camera checks speed in the direction in which you are driving.
	The camera checks speed in the opposite direction to that in which you are driving.
	The camera checks speed in both directions on the road.
	The camera can check speed in any direction.

Rear View Camera Operations

If the separately sold rear view camera is installed, you can play the rearward status on the display on shifting into the back gear.

CAUTION

The rear view camera plays a mirror-reversed video image to give the same view as a rear or side mirror. The way to view the image differs depending on vehicle model. Be careful when using it.

IMPORTANT

When using a high-pressure car-wash machine, take care not to directly turn the nozzles on or around the camera. Doing so may result in the camera falling off.

ATTENTION

- Do not place too much confidence in the rear view camera.
- Use the rear view camera as an additional tool to check for obstacles.
- Raindrops on the camera unit may result in a poor video image being displayed.
- Do not reverse your vehicle while only watching the monitor screen. Be sure to look through the rearview and side mirrors together and carefully check that conditions are safe around and to the rear of your vehicle.
- Do not use this machine in the following conditions.
 - While driving on frozen, slippery or snow-covered roads
 - On non-level surfaces such as slopes
 - When the rear door is not closed completely
 - When tire chains or temporary tires are being used
- When the display is cold, it may be difficult to recognize the contents of the video due to the screening of a darker image or an image lag. Be sure to visually check that conditions are safe around your vehicle while driving.
- The person or obstacle displayed on the screen is different from the actual position or difference due to the characteristics of the camera lens.
- Do not subject the camera unit to a strong impact, for example, hitting the camera unit or impacting the camera unit against a solid object. Doing so may displace the camera position or installation angle, resulting in the rear view camera malfunctioning.
- The camera unit has a waterproof structure. Do not remove, disassemble, or remodel the camera unit. Doing so may result in the rear view camera malfunctioning.
- If you rub or polish the camera cover strongly with an abrasive or brush with hard bristles, it may result in the cover becoming damaged, which may affect the video.
- The camera cover is made of resin. Do not allow any organic solvents, body wax, oil film remover, or glass coating solvent to come in contact with the camera cover. If such a material adheres to the cover, immediately wipe off it.
- If the temperature changes rapidly as a result, for instance, of spilling of hot water on the camera unit when it is cold, the rear view camera may malfunction.
- Hitting the camera unit may result in the rear view camera malfunctioning due to a camera failure. Have your authorized dealer check the problem early.
- Do not direct the camera lens at a brightly sunlight image for a long period of time. Doing so may result in a baking phenomenon occurring.
- The photograph shows an example. The range displayed on the screen varies depending on the vehicle model.

- When you change to back gear, the screen will turn white and then the image will quickly return to the screen.
- If the camera unit is exposed to strong light such as sunlight or headlights, a vertically-oriented white zone may appear.
- If the camera is used for a long period of time, white scratches or vertical lines appear as the temperature rises. Note that these phenomena are caused by the CCD characteristics.
- The rear view camera is equipped with a special lens; therefore, distances perceived through viewing the video screen will be different from actual distances.

Imaging with the Rear View Camera

■ When camera is set to AUTO

1 Shift to the back gear.

- This changes to the rear view camera screen.
- When you shift out of the back gear, the screen that was being displayed before the rearward images returns.



■ When camera is set to MANUAL

1 Press **MENU**.

2 Touch **Info**.



3 Touch **Camera Screen**.

- This changes to the rear view camera screen.
- Touch  to return to the immediately preceding screen.



Rear View Camera Operations

ATTENTION

- The image range displayed on the screen may vary depending on vehicle or road surface conditions.
- The image range displayed on the screen is limited; therefore, you cannot display something that is located near both ends of the bumper or under the bumper.
- Colors shown in the rearward image may be different from the actual colors of the objects.
- You can adjust the brightness and contrast of the screen. When you wish make adjustments, hold **AV** for a second or more and the Image quality adjusting screen will appear. See "Screen Adjustment and Setting" on page 33
- In the following cases, it may be difficult to watch the screen, but it is not an error.
 - In dark places (at night, etc.)
 - The temperature near the lens is high or low.
 - When there are water drops on the camera, or when humidity is high (during rain showers, etc.)
 - When foreign substances (mud, etc.) have become attached to locations near the camera.
 - The camera lens has been exposed directly to sunlight or the rays of headlights.
 - If a high-intensity point (sunlight reflected on the vehicle body, etc.) is reflected on the camera, it may result in a smearing phenomenon* particular to CCD cameras.

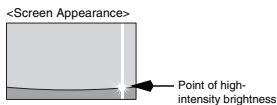

- * Smearing phenomenon: Refers to an image lag that is caused in the vertical direction of a high-intensity point (sunlight reflected on the vehicle body, etc.) on the camera.

Display of Connection Status Information

You can check connection status information for the connections between this receiver and the vehicle. These connections include those for GPS information and parking signals.

Display of Connection Status Information

1 Press **MENU**.

2 Touch **Info**.



3 Touch **System Check**.



● The Connection status information screen will open.



Item	Content	
GPS information	ON	GPS information being received.
	OFF	GPS information not being received.
Parking signal	ON	Parking brake is on.
	OFF	Parking brake is off.
Reverse signal	ON	Currently in back gear.
	OFF	Currently in gear other than back gear.

* When Navigation is not correctly installed, accurate information cannot be displayed.

Accuracy and Error

About measurement accuracy

GPS satellites are managed by the US Department of Defense and have a very high accuracy. However, when multipath effects are caused by reflections from buildings and the like, errors may occur.

About GPS Satellite Quality and Status

When there is obstruction between the GPS antenna and the GPS satellites, signals cannot be received. Since at least three signals must be simultaneously received to establish your position, Navigation cannot establish your position by GPS in the following locations.

When an obstruction (a load or the like) exists on or in the vicinity of the GPS antenna, it may not be possible to receive signals from the satellites.

CHECK

- Since the GPS satellites orbit the earth, the reception of signals at a given position varies with time. Note also that signals from satellites close to the horizon are susceptible to the effects of obstructions.
- GPS satellites are managed by the US Department of Defense and their accuracy is sometimes reduced deliberately.

Underground, in a tunnel or in an indoor parking structure Surrounded by obstructions such as tall buildings

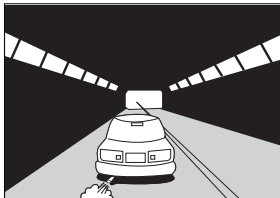

In a building

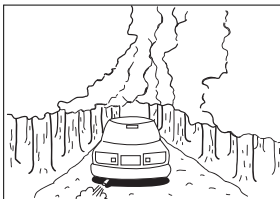
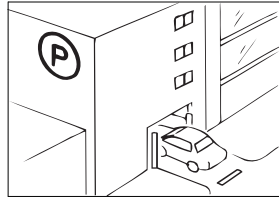

Densely wooded areas

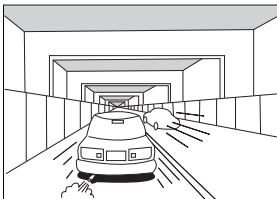

Under an elevated road

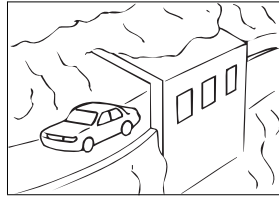

On a cliff side road or at a cavern opening

About Errors in Present Location Display

Since this receiver uses information from the GPS satellite signals to establish the present location, and the measurements from each of these include some error, the displayed present location may not match your actual position.

CHECK

When the displayed present location does not match your actual position, you can revise it. Stop somewhere safe, before revising.

About Correction of Vehicle Position Detection by Map Matching

Map matching refers to a system of comparing present location information obtained using GPS and the like with the roads which you have travelled on so far and correcting your present location so that you are on the most appropriate road.

This receiver uses road shapes to correct the present location information that has been obtained by combining independent measurements and satellite measurements.

However, since some error in the present location is unavoidable, the present location will sometimes differ from your actual position even after correction by map matching.

The vehicle mark may also leave the road you are driving on when it differs in form to the map data.

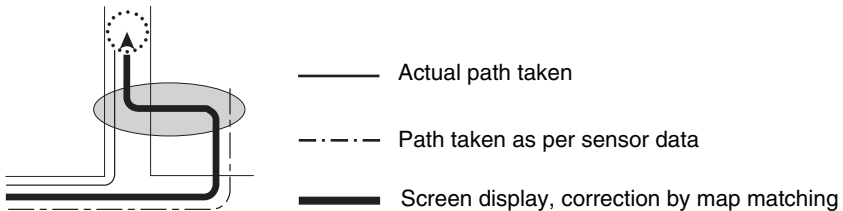

ATTENTION

Since this receiver does not operate in a stable manner when first switched on, the vehicle mark may differ from your actual position when you start moving. After a short while, operation stabilizes and normal operation will ensue.

About Accuracy of Present Position Display and Route Guidance

As shown in the following, under certain road and driving conditions, accurate present location and route guidance may not be available. This does not mean that your device is faulty.

Accuracy and Error

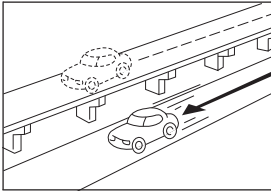

The present location appears on a road running parallel to the road taken.

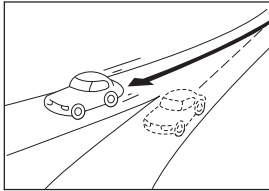

When turning on a road forking into two roads making a "Y" shape, the present location appears on the other road.

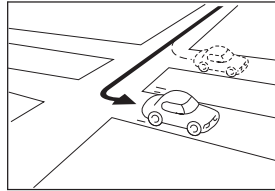

When making a turn, the present location appears on the road just before or after the road turned on.

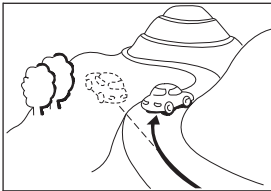

The present location appears misaligned when driving on steep roads.

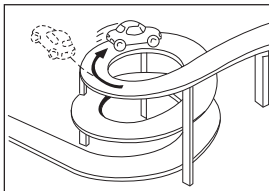

The present location appears misaligned when driving on a continuous curve in the same direction.

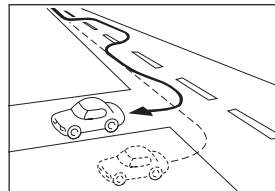

The present location appears misaligned when meandering such as changing lanes.

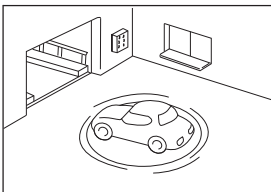

The present location appears misaligned when the vehicle is rotated on a parking structure turntable with the ACC turned OFF.

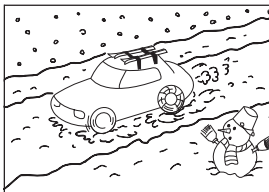

The present location appears misaligned when driving on a snowbound or slippery road or when using tire chains.

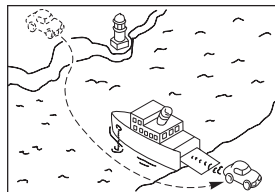

When the vehicle is moved by ferry or a means other than being driven, the GPS positioning will indicate a present location on the spot where the vehicle was prior to being moved.

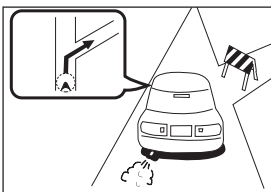

When route guidance indicates a road that is actually blocked off (regular traffic prohibited).

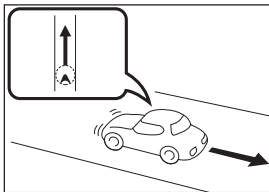

The present location appears misaligned when turning back.

About Road and Place-Name Data

There is always a possibility that roads and place-names will be modified after creation of the map data, in which case the provided names will differ from the actual names.

About Route Guidance

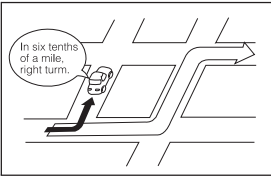

When having turned on an intersection that is not part of the route guidance, there may be an error in the voice guidance instructions.

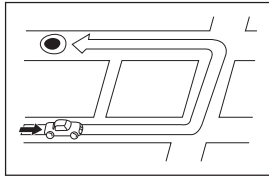

When searching for a route, the route provided may include a detour.

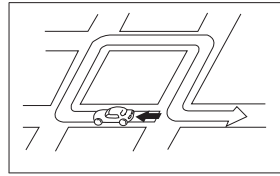

The route guidance may instruct a U-turn.

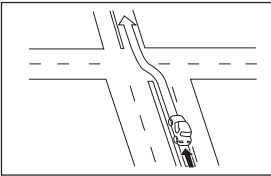

When driving on a straight road, the route guidance may instruct you to go straight (in cases where the shape of intersections is difficult to determine).

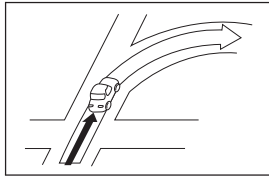

No route guidance may occur even if turning at an intersection.

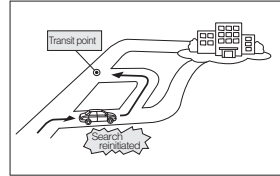

When driving towards the destination without passing through a transit point, the device may reinitiate a route search and provide a new route that takes you towards that transit point.

Accuracy and Error

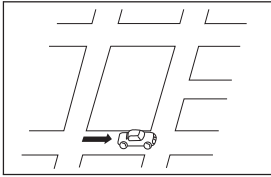

When searching for a route, the route display may not appear in time for the next turn.

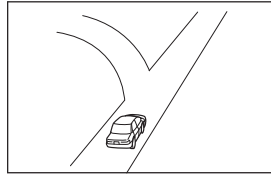

While providing guidance on where you are headed, several geographical names may be indicated.

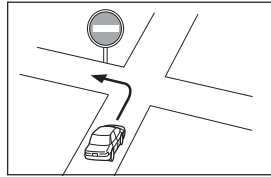
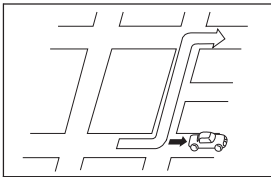

Drive following the actual traffic regulations.

- When you are driving at high speed, it may take longer to perform the search.
- Your route may not change even if you initiate another search.
- When an island or somewhere where there are no guidable roads is set as your present location/destination, a route may not be found.
- When the present location and destination are close together, the route may not be displayed.
- Toll roads are not necessarily used, even when you have selected to prioritize toll them. In the same way, toll roads may appear on the route even when you have selected to not prioritize them.
([Prioritize/do not prioritize toll roads] sets which type of road to use when both toll roads and normal roads are available.)

Before Use

⚠ CAUTION

- Be very careful and pay full attention to safety when operating the audio controls while driving. Otherwise accidents may occur. Also, be sure to set the volume so that you can still adequately hear sounds outside the vehicle.

Improper use may result in a traffic accident.

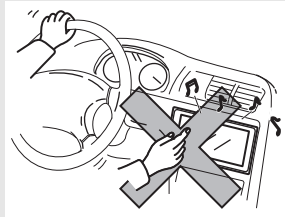

- Never continue to use the system if it is malfunctioning in any way. If smoke, abnormal noises or abnormal odors are noticed, turn off the power immediately. Immediately turn off the audio in such situations.

Exercise caution regarding the temperature inside the vehicle.

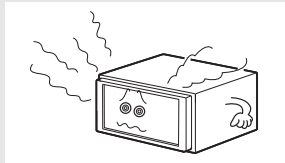

- The temperature inside the vehicle can increase during hot weather.

Wait for the temperature inside the vehicle to drop before using this receiver.

Otherwise damage may result.

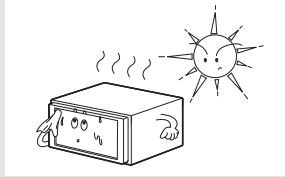

- Do not disassemble or modify this receiver.

The main unit has a precisely designed structure, so consult your retailer in the event any unsatisfactory performance is observed.

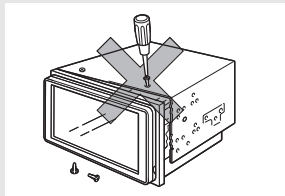

- Do not apply excessive force to the monitor.

Damage could result.

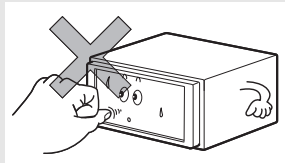

- Do not leave the monitor in tilt position when you are not using it.

Otherwise, it may be damaged.

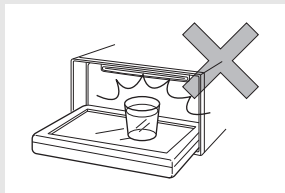

Before Use

- Do not insert any objects other than discs into the disc slot.
Damage could result.

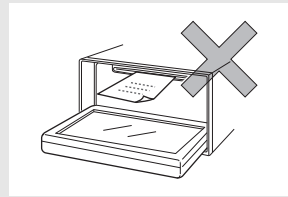

- Be careful not to get your fingers or other objects caught behind the monitor when it is being retracted into place.
Interference can cause an injury or damage the main unit.

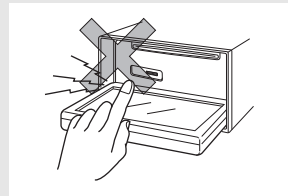

- When removing a disc or "SD memory card" from this receiver, remove it horizontally.
Do not pull up or press down forcibly while removing.
Improper removal may result in the disc becoming scratched, causing the receiver to emit unusual noises. Improper removal of the "SD memory card" may damage it.

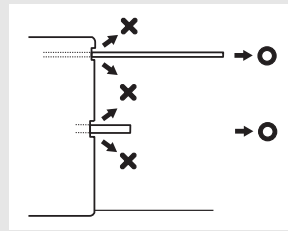

About Discs

ATTENTION

- In cold or rainy weather, just as the interior glass surface becomes fogged, dew (water condensation) may also settle on the receiver. When this occurs, disc playback may become intermittent or impossible. Dehumidify the air in the vehicle for a while before resuming playback.
- If a problem occurs, the player function stops automatically to protect its internal parts. If the player does not operate even when you follow the on-screen messages, the player may have failed. Consult the dealer you purchased it from.
- Playback may be intermittent when the player is subjected to severe vibrations while traveling over a rough surface.
- Please do not use a commercially available lens cleaner because it may cause damage to the pickup of the player.

■ Formatting discs

- An audio disc or DVD video disc bearing one of the marks below can be played.

When using a DVD±R/RW (DVD±Recordable/ReWritable) disc, note that only the disc whose contents were recorded in the video mode can be played. Discs whose contents were recorded in the video recording (VR) mode and audio mode cannot be played.



- The Dolby Digital format is supported, and a disc having the following logo can be played.



This product is manufactured under license from Dolby Laboratories. Dolby and the double-D symbol are registered trademarks of Dolby Laboratories.

- It is possible that a CD-R (CD-Recordable) or CD-RW (CD-ReWritable) disc will not play on the main unit due to the characteristics of the recording or special disc, scratches, dirt or deterioration caused by long-term storage in the vehicle. Also, a CD-R or CD-RW disc that has not yet been finalized and a CD-R or CD-RW disc recorded in UDF format cannot be played.
- It is possible that a DVD±R/RW (DVD±Recordable/ReWritable) disc will not play on this receiver due to the characteristics of the recording or special disc, scratches, dirt or deterioration caused by long storage in the vehicle. Also, a DVD±R/RW disc that has not yet been finalized cannot be played. It may not be possible to play a disc that has been recorded on a personal computer, depending on the application setting and the environment.
- The CD-TEXT function can be used only for CD-text CDs available on the market. Characters written on a CD-R and CD-RW discs may not be displayed correctly.

Before Use

- Do not use a CD and a See Through disc having a transparent or semi-transparent recording area as they may fail to load or unload or play their contents.
- A Copy Control CD (CCCD) may not be played as it does not meet the official CD Standard.



■ Handling discs

- Do not place a disc in direct sunlight; store each disc in their protective cases. Otherwise, discs may warp and fail to play.

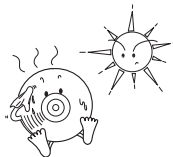

- Do not apply paper-based tape to either the recording side or label side of a disc. Damage could result.

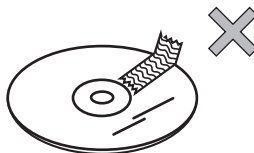

- Do not use cracked or badly warped discs. Damage could result.



- Do not touch the recording area (the rainbow colored) side of a disc. Otherwise, the disc may become dirty and playback may be intermittent.



- If you play a dirty disc, the disc surface may be scratched and its play may be intermittent. Use a commercially available compact disc cleaner to clean the CD, wiping gently from the center to the edge.



■ Brand new CDs

- You may notice that some brand new discs are rough around the center hole or outside. In this case, remove burrs or flakes around the edge using the side of a ballpoint pen before using a new disc. Not doing so may result in burrs or flakes becoming stuck on the recording side, preventing playback.

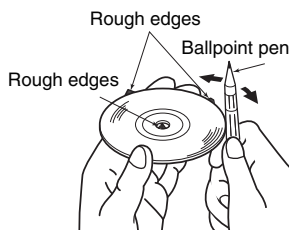

■ Rental discs

- Do not use a rental disc with glue or remnants of adhesive tape or labels. They may cause the disc to get stuck inside or damage the main unit.

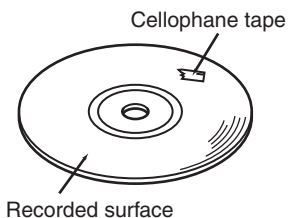

■ Irregularly-shaped CDs

Specially-shaped or octagonal CDs, such as heart-shaped CDs cannot be played. Do not play this type of disc, even with an adapter. Damage to the player could result.

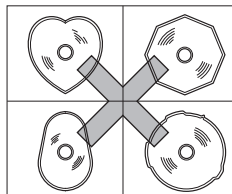

■ Disc accessories

- Do not use accessories (stabilizers, protective seals, laser lens cleaners, etc.) sold for improving sound performance or protecting CDs. The changes in CD thickness or outside dimensions made by these accessories may cause problems in the player.
- Please be sure NOT to attach any ring-shaped protector (or other accessory) to your discs. Although these protectors are commercially available and said to protect discs and improve sound quality (and anti-vibration effect), in normal use they can do more harm than good. The most common problems are Insert/Eject related problems and No playback problems due to the protector ring coming off in the disc mechanism.

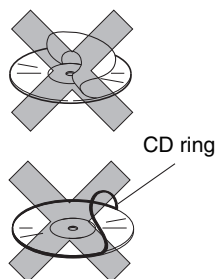

Switching Audio Source

Switching the Audio Source

- 1 Press **MENU**.
- 2 Select the Audio mode you wish to use.



Display of Audio Operations Screen

- 1 Press **AV**.

Stopping audio mode

- 1 Press **MENU**.
- 2 Touch **Audio Off**.
 - Touch **Audio Off** again to receive the station you were receiving, the music you were playing or the video you were playing when you stopped the radio.



Source Operations Screen

The Source operations screen appears as follows.

- Radio (AM) screen



- Satellite radio (SIRIUS) screen (optional)



- Radio (FM) screen



- Bluetooth audio screen



- HD Radio screen (optional)



- CD Player screen



- Satellite radio (XM) screen (optional)



- MP3/WMA screen



Source Operations Screen

- DVD screen



- DivX screen



- VTR screen

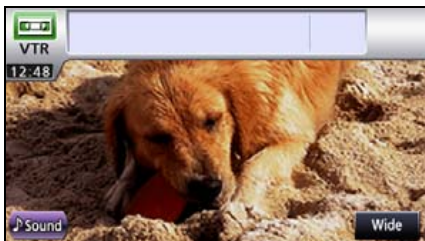

- iPod screen (optional)



- USB screen



ATTENTION

Operation screen will be cancelled automatically when no operation is performed for 6 seconds in the visual operation screens) DVD, DivX, iPod Video, and VTR.

Volume Control

Main Volume Control

1 Press the VOL switch.

- **+** (Right-hand side)
Increases volume
- **-** (Left-hand side):
Decreases volume
- Press **+** for at least one second will continue to increase the volume.
Press **-** for at least one second will continue to decrease the volume.



①

① Volume switch

ATTENTION

- Adjust the volume level that does not affect on your safety driving.
- You can control the volume level from 0 to 80.
- The actual sound level may vary when you have switched the audio source. Adjust the sound level appropriately according to the audio source you select.

Adjusting sound quality

You can set the sound quality and adjust the sound balance and the like.

Display of Audio Settings Screen

When you switch to the Audio settings screen from any of the Audio operations screens, the following operations are available.

- Adjusting audio balance
- Adjusting woofer
- Setting loudness
- Setting source volume control
- Adjusting sound quality

1 Touch **Sound** on any of the audio operations screens.

2 Touch the switch you wish to set.

- Touch **Done** to return to the immediately preceding screen.



Adjusting audio balance

You can adjust the forward and back, and left and right balance.

1 Touch **BAL/FAD Setting**.



2 Touch the desired balance point.

- To fine adjust, touch any of the balance switches **▲**, **▼**, **◀**, **▶** to change the corresponding value by 1.

When you touch and hold one of the balance adjusting switches **▲**, **▼**, **◀**, or **▶**, the balance will continue to change, but stop at the center value. To continue to change the balance, touch one of the balancing switches again.

- Touch **Center** to cancel the fader/balance settings value and return to the center values.
- On completion, touch **⏪** to store the setting and return to the immediately preceding screen.

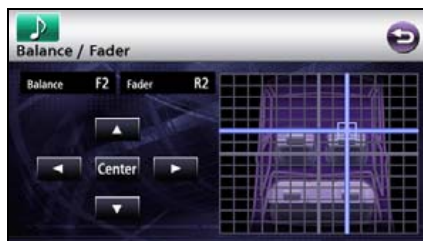

Sub-Woofers Settings

You can adjust the audio output when a sub-woofer is connected.

■ Setting sub-woofer level

You can adjust the sub-woofer output level.

1 Touch **Woofer Setting**.



2 Touch ▲ or ▼ of the woofer level.

- You can set the output at any of 13 output levels (+6 to -6).
- After completing the setting, touch **Done** to store the setting and return to the immediately preceding screen.



■ Switching the phase

The sound outputted from the sub-woofer includes the same frequency bands as the sound from the front/rear speakers, and cancellation can occur under some in-vehicle conditions. Switch the phase of the sub-woofer to prevent this phenomenon. You can set the phase in according to the in-vehicle conditions.

1 Touch **Normal** or **Reverse**.

- **Normal** : Sets the output timing of the speakers and sub-woofer to be the same.
- **Reverse** : Staggers the output timing of the speakers and sub-woofer.
- After completing the setting, touch **Done** to store the setting and return to the immediately preceding screen.



Adjusting sound quality

■ Setting low pass filter

The low pass filter cuts out frequencies higher than the set frequency (high-band frequencies) and allows lower frequencies (low-band frequencies) to pass.

1 Touch **ON** or **OFF**.

- After completing the setting, touch **Done** to store the setting and return to the immediately preceding screen.



Setting Loudness

You can correct for the lack of satisfaction at high and low frequencies when listening at low volume to give better modulated sound.

1 Touch **Loudness** on the Settings screen.

- On completion, touch **Done** to store the setting and return to the immediately preceding screen.



Setting Source Volume Control

You can set a volume difference for each audio mode. The differences between the volume of the FM mode in the initial state (initial value: 40), which is used as reference, and the volume levels set for each audio mode are stored.

1 On the Audio settings screen, touch the ▲ or ▼.

- After completing the setting, touch **Done** to store the setting and return to the immediately preceding screen.



Setting example:

Audio mode	FM	AM	CD	USB	BT-Audio
Initial value (Volume level)	Reference (40)	0 (40)	0 (40)	0 (40)	0 (40)
SVC Setting (Volume level)	Reference (40)	SVC setting value +15 (55)	SVC setting value -10 (30)	SVC setting value +5 (45)	SVC setting value -5 (35)
When volume level is adjusted from 40 → 45 in FM mode	45	55→60	30→35	45→50	35→40
When volume level is adjusted from 35 → 60 in CD mode	45→70	60→85*	60	50→75	40→65
When volume level is adjusted from 80 → 20 in AM mode	70→5	20	60→0*	75→10	65→0
When volume level is adjusted from 10 → 35 in USB mode	5→30	20→45	0→20	35	0→25

* You can set the volume level in a range of 0 (minimum) to 80 (maximum). Set the volume level differences in a range of -10 to +20.

Adjusting sound quality

Adjusting Sound Quality

You can adjust sound quality in the low band, the medium band and the high band.

■ Adjusting sound quality

1 Touch **EQ Setting**.



2 Touch **Bass**, **Mid**, or **Treble**.



3 Touch **▲** or **▼**.

- When you touch and hold, the value changes continuously but stops at the center value. Touch **▲** or **▼** again to continue to change the value.
- It is also possible to adjust to preferred level by touching the screen.
- The maximum adjustment is +6 and the minimum adjustment is -6.
- On completion, touch **⏪** to store the setting and return to the immediately preceding screen.

■ Storing sound quality

You can store the adjusted sound quality.

1 Adjust the sound quality.

2 Touch **Custom** for at least one second.

- On completion, touch **⏪** to store the adjustment and return to the immediately preceding screen.



■ Use a preset sound quality

1 Touch **EQ Setting**.



2 Touch **Power** (Low-band enhancement), **Sharp** (High-band enhancement), **Vocal** (Mid-band enhancement), or **Custom** (User preset value).

● To reset the sound quality, touch **Flat**.



Screen Settings

Switching Between Screen Modes

CHECK

You can switch the screen mode from DivX, DVD, iPod Videos, or VTR settings screen.

1 Opens Video settings screen.

- The Video settings screen can be set up to show the following operations.

DivX: Touch **Set** on the operation screen.

DVD: Touch **Next** on the Operations screen, and then touch **Set** on the screen that opens.

iPod Video: Touch the Operations screen.

VTR: Touch the Video screen.

2 Touch **Wide**.

3 Touch **Normal**, **Wide1** or **Wide2**.



- Normal

The picture is shown with a 3 (vertical) by 4 (horizontal) aspect ratio (normal TV screen proportions) and black side edges.



- Wide1

A picture with a 3 (vertical) by 4 (horizontal) aspect ratio (normal TV screen proportions) is uniformly expanded in the left and right directions.



- Wide2

A picture with a 3 (vertical) by 4 (horizontal) aspect ratio (normal TV screen proportions) is uniformly expanded in the up, down, left and right directions.

ATTENTION

The user should not experience any problems when watching a video on the wide screen on a personal basis. If you compress or enlarge the screen for commercial purposes or to display to the public, it may infringe a copyright that is protected by copyright laws.

About Remote Control

Remote Control Operations

■ Precautions for use

- The remote control is small and light, so care must be taken when using it. Dropping it or knocking it against something may cause it to break, start to consume batteries faster, or malfunction.
- Keep the remote control away from humidity. Do not spill water or other liquids on it. Do not strike the remote control.
- Do not place the remote control in areas exposed to high temperatures, such as the dashboard and heater outlets. If the remote control is placed in a high-temperature location, the case can warp and other faults can develop.
- Do not operate the remote control when driving as this may lead to accidents.
- When using the remote control, point it towards the remote control receiver.
- The remote control receiver, may not operate correctly when exposed to direct sunlight or other bright lighting.
- When you do not plan to use the remote control for a long period, remove the batteries.

■ About cleaning

- When the remote control is dirty, wipe with a dry cloth. If the remote control is very dirty, dab a diluted cleaning agent on a cloth and wipe.
- Never use a benzene, a thinner, or other solvent. Such a solvent will damage the case or coating.

Remote control

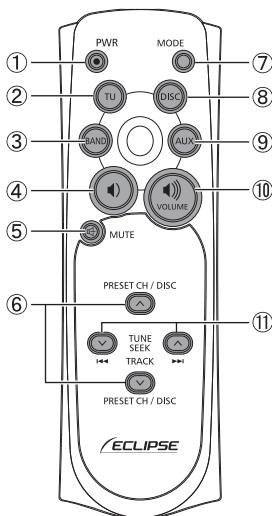

Number	Name/Function
①	[PWR] button Turns the power of the main unit ON or OFF.
②	[TU] button Switches among AM, FM, SIRIUS and XM.
③	[BAND] button Changes the radio band.
④	[V] button Reduces volume (including hands-free mode).
⑤	[MUTE] button Mutes or cancels the mute.

About Remote Control

Number	Name/Function
⑥	[√PRESET CH ^] button [√ DISC ^] button Performs an operation for selection of the preset channel, for the disc, USB or iPod.
⑦	[MODE] button Switches among audio source modes.
⑧	[DISC] button Switches among DISC, USB and iPod.
⑨	[AUX] button Switch between VTR and BT Audio
⑩	[4)] button Increases volume (including hands-free mode).
⑪	[√ TUNE/SEEK ^] button [←← TRACK →→] button Used to select among tracks from a radio broadcast, DISC, USB or iPod.

- 2** Set the two batteries in the battery compartment as indicated.

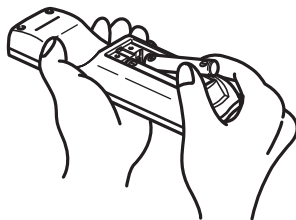

- 3** Close the battery case by pushing the rear panel in the direction of the arrow.

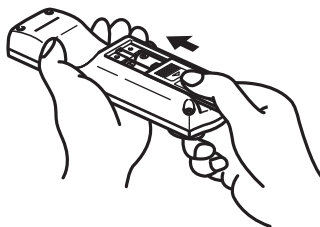

Exchanging Batteries

WARNING

To prevent accidents, keep batteries out of the reach of children. In the unlikely case that a child does swallow a battery, see a doctor immediately.

Use a pair of AAA batteries.

- 1** Open the rear panel of the remote control by pushing in the direction of the arrow.

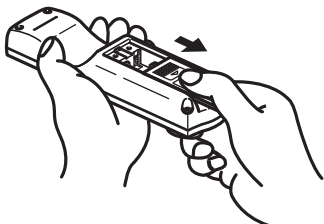

Using Radio

Using Radio

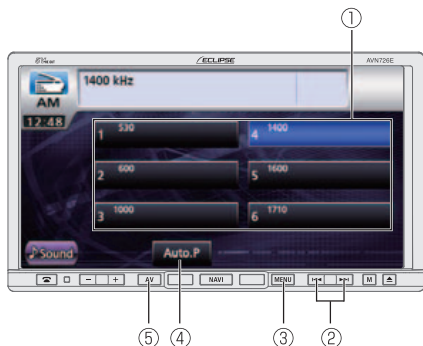

- ① Preset switch
- ② TUNE UP/DOWN button
- ③ MENU button
- ④ AUTO.P switch
- ⑤ AV button

Listening to Radio

1 Press **MENU**.

2 Touch **AM** or **FM**.



Tune a Desired Station.

CAUTION

If the vehicle's battery is disconnected (for repairs to the vehicle or for removing the main unit), all the stations held in the memory will be lost. In such a case, set stations in the memory again.

IMPORTANT

At times, it may be difficult to maintain optimum reception because the antenna affixed to your vehicle is in motion constantly (relative to the broadcast antenna), and encounters continuous variation in the strength of received radio signals. Other factors affecting reception include interference from natural obstacles, sign posts, etc.



Manual Tuning

1 Press **▶▶** or **◀◀**.

- To the right:
Move up one step.
- To the left:
Move down one step.

Using Radio

Auto Tuning

- 1 Press  or  and hold for at least 1 second.
 - When a station having the frequency closest to the one shown on the screen is tuned, the auto tuning stops. To cancel auto tuning, press the button again.

ATTENTION

Auto tuning may fail if the received signal is weak.

Selecting from preset switch

- 1 Touch a preset switch stored in memory.
 - The registered preset channel will be selected and the corresponding station will be received.



Selecting Radio Band

CHECK

You can switch the receiving band of FM radio when in FM radio mode.

- 1 Touch **Band**.
 - Each touch of **Band** switches to next receiver band.
FM1 → FM2 → FM3 → FM1 → ...



Saving Station in Memory

You can save a radio station in memory in the auto or manual mode.

Manual saving

- 1 Select a station you wish to save by Manual tuning or Auto tuning.
- 2 Touch and hold the preset switch for at least 1 second.

- The selected station will be saved, and the preset channel number and frequency will be shown on the display.



- To manually set additional selected stations for the remaining preset channels, repeat this procedure for each channel.
- Six stations can be memorized for each of FM 1, 2 and 3, and six stations can be memorized for AM, making a total of 24 stations.
- If the stations have been stored in memory, a station can be selected and received by the touching the appropriate preset switch.

Automatic saving

IMPORTANT

- You can select a station by simply touching a preset switch (any of [1] to [6]). The frequency of the selected station appears.
- When you save a new station in memory, the existing station is cleared to make way for it.
- If fewer than six stations can be received, the left over switches retain their original settings.

- 1 Touch **Auto.P** for at least one second.

- A search will be conducted from the lowest frequency through progressively higher frequencies, and stations with sufficiently strong reception will be memorized for preset registration numbers [1] to [6]. The registration procedure has been completed, a beep sounds twice and the station memorized last (i.e. the one memorized for P6) will continue to be received. Subsequently, when you listen to the radio you will be able to select stations by calling up preset numbers.



Using HD Radio

Using HD Radio

When the optional HD Radio tuner is connected you can receive HD Radio.

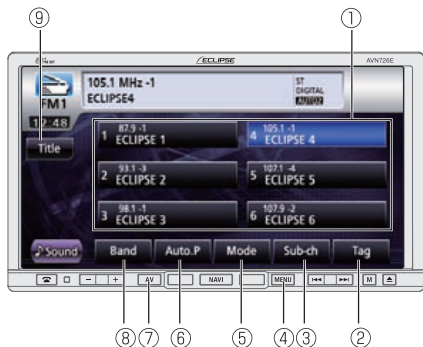

- ① Preset switch
- ② TAG switch
- ③ Sub-ch switch
- ④ MENU button
- ⑤ Mode switch
- ⑥ AUTO.P switch
- ⑦ AV button
- ⑧ Band switch
- ⑨ Title switch

ATTENTION

- When an HD Radio tuner is connected and receiving a digital station, "DIGITAL" appears.
- When an HD Radio tuner is connected, **Title** is enabled.
- By repeatedly touching **Mode**, you can cycle through the receiving modes as follows.
AUTO1 → AUTO2 → OFF → AUTO1 → ...
- AUTO1: Receive while giving priority to digital stations
AUTO2: Receive while giving priority to digital stations, limit SEEK to digital stations.
OFF: Receive analog stations
- The HD Radio logo is a registered trademark of iBiquity Digital Corp.

Listening to Radio

1 Press **MENU**.

2 Touch **AM** or **FM**.



Select Desired Station

CAUTION

If the vehicle's battery is disconnected (for repairs to the vehicle or for removing the main unit), all stations in memory will be lost. In such a case, set stations in the memory again.

IMPORTANT

At times, it may be difficult to maintain optimum reception because the antenna affixed to your vehicle is in motion constantly (relative to the broadcast antenna), encountering continuous variation in the strength of received radio signals. Other factors affecting reception include interference from natural obstacles, sign posts, etc.

Manual Tuning

1 Press  or .

- To the right:
Move up one step.
To the left:
Move down one step.

Auto Tuning

1 Press  or  and hold for at least 1 second.

- When a station having the frequency closest to the one shown on the screen is tuned, the auto tuning stops. To cancel auto tuning, press the button again.

ATTENTION

Auto tuning may fail in regions where the received signal is weak.

Selecting from preset switch

1 Touch a preset switch stored in memory.

- The registered preset channel will be selected and the corresponding station will be received.



Selecting a Radio Band

1 Touch **Band**.

- Each touch of **Band** switches to next receiver band.
FM1 → FM2 → FM3 → FM1 → ...



Using HD Radio

Saving Station in Memory

You can save a radio station in memory in the auto or manual mode.

Manual Saving

1 Select a station you wish to save by Manual tuning or Auto tuning.

2 Touch and hold the preset switch for at least 1 second.

- The selected station will be saved, and the preset channel number and frequency will be shown on the display.
- To manually set additional selected stations for the remaining preset channels, repeat this procedure for each channel.
- Six stations can be memorized for each of FM 1, 2 and 3, and six stations can be memorized for AM, making a total of 24 stations.
- If the stations have been stored in memory, a station can be selected and received by the touching the appropriate preset switch.



Automatic saving

IMPORTANT

- You can select a station by simply touching a preset switch (any of [1] to [6]). The frequency of the selected station is displayed.
- When you save a new station in memory, the existing station is cleared to make way for it.
- If fewer than six stations can be received, the left over switches retain their original settings.

1 Touch **Auto.P** for at least one second.

- A search will be conducted from the lowest frequency through progressively higher frequencies, and stations with sufficiently strong reception will be memorized for preset registration numbers [1] to [6]. On completion of the registration procedure, a beep sounds once and the station memorized last (i.e. the one memorized for P6) will continue to be received. Subsequently, when you listen to the radio you will be able to select stations by calling up preset numbers.



Displaying title information

You can display album names, titles, artist names and genres during broadcasts.

1 Touch **Title**.



2 Touch **Preset** to return to the Radio preset screen.



Obtaining Tag Information

When Tag information is available for a track during a broadcast, you can acquire it.

1 Touch **Tag**.

- When an iPod connected, the Tag information is transferred to it.
- When an iPod is not connected, the Tag information is stored by the HD radio tuner and automatically transferred to the iPod when it is next connected.



Using HD Radio

Receiving Sub-channel Broadcasts

You can receive a sub-channel broadcasts, when they are available from the station being received.

1 Touch **Sub-ch**.

- Touch repeatedly to cycle through the sub-channels.



How to Use SIRIUS Satellite Radio

Using SIRIUS satellite radio

When an optional SIRIUS satellite radio tuner is connected, SIRIUS satellite radio broadcasts can be received.

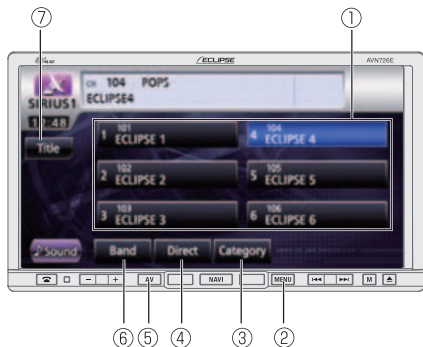

- ① Preset switch
- ② MENU button
- ③ Category switch
- ④ Direct switch
- ⑤ AV button
- ⑥ Band switch
- ⑦ Title switch

Listening to SIRIUS Satellite Radio

With SIRIUS satellite radio, over 100 channels are available including music, news, and entertainment programs.

You can select the channel you want from categories such as POP and ROCK, or you can select a channel by directly entering it.

SIRIUS satellite radio is a subscriber service.

1 Press **MENU**.

2 Touch **SIRIUS**.



How to Use SIRIUS Satellite Radio

Checking SIRIUS ID

The SIRIUS ID number is a 12-digit numerical code that is assigned each time the SIRIUS satellite radio tuner is connected.

1 Touch **Direct**.



2 Enter **0**.



3 Touch **Done**.

- A 12-digit numerical code is displayed.

Changing SIRIUS Band

1 Touch **Band**.

- The BAND changes as follows.
SIRIUS1 → SIRIUS2 → SIRIUS3 → SIRIUS4 → SIRIUS1 → ...





Selecting Channel to Listen to

Selecting from category

1 Touch **Category**.



2 Touch the category you wish to listen to.

- If there are more than 6 categories, it is possible to switch the list of categories by touching  or .



Manually selecting channel

1 Press  or .

- Right: Selects a higher channel.
Left: Selects a lower channel.

Automatically selecting channel

1 Press  or  and hold for at least 1 second.

- Searches for channels in the currently selected category.

ATTENTION

Auto tuning may fail in districts where the received signal is weak.

Selecting a channel by entering it directly.

1 Touch **Direct**.



2 Enter a channel.

- Each touch of **Clear** deletes a single character.



3 Touch **Done**.

How to Use SIRIUS Satellite Radio

Saving Channels

IMPORTANT

If the vehicle's battery is disconnected (for repairs to the vehicle or for removing the main unit), all channels in memory will be lost. In such a case, set channels in the memory again.

1 Tune into the station to be saved.

2 When you have tuned in to the station you wish to save, touch and hold the preset switch for at least 1 second.

- The selected station will be saved.

To set additional manually selected stations for the remaining preset channels, repeat this procedure for each preset channel.

Subsequently, when listening to the satellite radio you will be able to tune into stations by touching the preset switches.



Selecting Preset Channel

1 Touch one of the touch switches, [1] to [6], that appear on the display.

- The station preset to the selected touch switch is received.



Displaying Information about Current Broadcast

When receiving a SIRIUS broadcast, you can display information about the current broadcast, such as the channel, category, track title, artist, and channel number.

1 Touch **Title**.



2 Touch **Preset** to return to the Radio preset screen.



How to Use XM Satellite Radio

Using XM Satellite Radio

When an optional XM satellite radio tuner is connected, XM satellite radio broadcasts can be received.

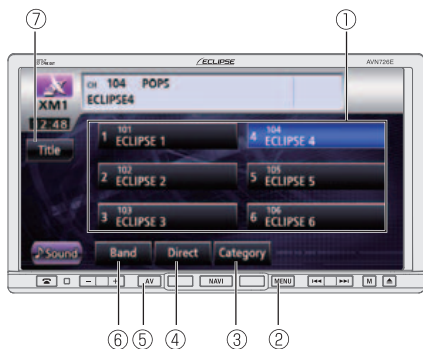

- ① Preset switch
- ② MENU button
- ③ Category switch
- ④ Direct switch
- ⑤ AV button
- ⑥ Band switch
- ⑦ Title switch

Listening to XM satellite radio

With XM satellite radio, over 100 channels are available including music, news, and entertainment programs.

You can select the channel you want from categories such as DANCE and ROCK, or you can select a channel by entering it directly.

XM satellite radio is a subscriber service.

1 Press **MENU**.

2 Touch **XM**.



Checking RADIO ID

The RADIO ID number is an 8-digit numerical code that is assigned each time the XM satellite radio tuner is connected.

1 Touch **Direct**.



2 Touch **0**.



3 Touch **Done**.

- An 8-digit numerical code is displayed.

Changing XM Band

1 Touch **Band**.

- The BAND changes as follows.

[XM1] → [XM2] → [XM3] → [XM4] → [XM1]
→ ...



Selecting Channel to Listen to



Selecting from category

1 Touch **Category**.



How to Use XM Satellite Radio

2 Touch the category you wish to listen to.

- If there are more than 6 categories, it is possible to switch the list of categories by touching  or .



Manually selecting channel

1 Press  or .

- Right: Selects a higher channel.
Left: Selects a lower channel.

Automatically selecting channel

1 Press  or  and hold for at least 1 second.

- Searches for channels in the currently selected category.

ATTENTION

Auto tuning may fail in districts where the received signal is weak.

Selecting a channel by entering it directly.

1 Touch **Direct**.



2 Enter a channel.

- Each touch of **Clear** deletes a single character.



3 Touch **Done**.

Saving Channels

IMPORTANT

If the vehicle's battery is disconnected (for repairs to the vehicle or for removing the main unit), all channels in the memory will be lost. In such a case, set channels in the memory again.

1 Tune into the station to be saved.

2 When you have tuned in to the station you wish to save, touch and hold the preset switch for at least 1 second.

- The selected station will be memorized. To set additional manually selected stations for the remaining preset channels, repeat this procedure for each preset channel.

Subsequently, when listening to the satellite radio you will be able to tune into stations by touching the preset switches.



Selecting Preset Channel

1 Touch one of the touch switches, [1] to [6], that appear on the display.

- The station preset to the selected touch switch is received.



Displaying Information about Current Broadcast

When receiving an XM broadcast, you can display information about the current broadcast, such as the channel number, channel, artist, feature, track, and program title.

1 Touch **Title**.



How to Use XM Satellite Radio

2 Touch **Preset** to return to the Radio preset screen.



Using CD Player

Using CD Player



- ① Track UP/DOWN, Fast UP/DOWN button
- ② MENU button
- ③ Scan switch
- ④ Random switch
- ⑤ AV button
- ⑥ Repeat switch

Listening to CD

Insert a CD into the disc slot, and it will start playing.

CAUTION

- Do not press the **[▲(OPEN/EJECT)]** button when you are inserting a CD into disc slot. This may cause a personal injury or damage the front panel.
- Do not drive your vehicle while the front panel of this receiver is open. The panel may cause personal injury in the case of a sudden stop or similar event.
- Do not attempt to close the front panel by hand. Doing so may damage the panel.

IMPORTANT

Playback may be intermittent when there is a scratch on a CD or when the recorded side is dirty.

1 Press **[MENU]**.

2 Touch **DISC**.

- The disc starts to play.



ATTENTION

- If track titles and other data are recorded in the CD-Text format, you can display them.
- Note that the CD-Text of a CD-R/RW disc may not be displayed.

Selecting Track to Listen to

You can cue a desired track.



1 Press **[▶▶]** or **[◀◀]**.

- Right: Advances to the next track.
Left (pressing once): Returns to the beginning of the track being played.
Left (pressing more than two times): Returns to the previous track.

Using CD Player

Fast Forwarding/ Rewinding

You can fast forward or rewind the track currently being played.

- 1 Press  or  and hold for at least 1 second.

- To the right:
Fast forwards a track.
To the left:
Rewinds a track.
Fast-forwards (rewinds) until finger is removed from switch.

Finding Desired Track

- 1 Touch **Scan**.

- The main unit will play the first 10 seconds of each track. When you touch **Scan**, the current track will continue to play.



Repeating Same Track

- 1 Touch **Repeat**.

- The track repeats.
- When you touch **Repeat**, the track repeats until this function is cancelled.
Touch **Repeat** again to cancel the repeat play.



Random Play

- 1 Touch **Random**.

- The tracks of the current CD are played in random order.
- When you touch **Random**, the random play continues until you cancel it.
When you touch **Random** again, the random play is cancelled.



Using MP3/WMA Player

Using MP3/WMA Player

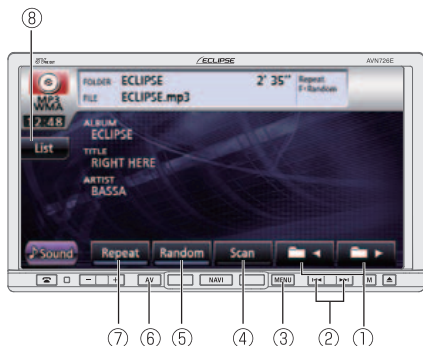

- ① Folder/file selection switch
- ② File UP/DOWN, Fast UP/DOWN button
- ③ MENU button
- ④ Scan switch
- ⑤ Random switch
- ⑥ AV button
- ⑦ Repeat switch
- ⑧ List switch

Playing MP3/WMA File

When you insert a CD-R/RW disc containing an MP3/WMA file into disc slot, the file is played.

CAUTION

- Do not press the [▲(OPEN/EJECT)] button when you are inserting a CD into disc slot. This may cause a personal injury or damage the front panel.
- Do not drive your vehicle while the front panel is open. The panel may cause personal injury in the case of a sudden stop or similar event.
- Do not attempt to close the front panel by hand. Doing so may damage the panel.
- If a non-MP3/WMA file has the “.mp3” or “.wma”; file extension, it may be recognized erroneously as an MP3/WMA file. When such a file is played, noise of large magnitude is outputted the speakers may be damaged. Take care not to assign the “.mp3” and “.wma”; extensions to non-MP3/WMA files.

IMPORTANT

- Playback may be intermittent when there is a scratch on a CD or when the recorded side is dirty.
- The CD-ROM supports a folder or file selection function.

Using MP3/WMA Player

- 1 With a CD-R/RW inserted, press **MENU**.

- 2 Touch **DISC**.

- The disc starts to play.
- The usual playing order is 1 → 2 → 3 → 4 → 5 → 6. (See page 163)
- If multiple MP3/WMA files and folders are located in the same hierarchy, they are played in the ascending order of file name and folder name.
- If you try to create a non-MP3/WMA format file, "NO SUPPORT" warning is displayed.



Selecting desired folder

You can select a desired folder from the disc.

Selecting from folder list

- 1 Touch **List**.





- 2 Touch **Play**.

- Plays first track in folder.
- When the following screen is displayed, touch ▲ or ▼ to change between items.
- Touch ↻ to return to the immediately preceding screen.



Select from linked folders

1 Press  or .

- : Goes to previous folder and plays the first track in this folder.
- : Goes to folder one level higher and plays the first track of this folder.



ATTENTION

If no MP3 files exist in the folder, "NO DATA" will appear in the section where the file name and folder name are displayed.

Selecting Desired Music File



You can select a desired music file from the folder.

Selecting from file name switch

1 Touch **List**.





2 Select the folder you wish to use.

- When the following screen is displayed, touch  or  to change between items.
- Touch  to return to the immediately preceding screen.



3 Touch the file you wish to play.

- This plays the selected music file.
- When the following screen is displayed, touch  or  to change between items.
- Touch  to return to the immediately preceding screen.



Using MP3/WMA Player



Select from linked files

1 Press  or .

- Right: Advances to the next file.
Left (Press once.): Returns to the beginning of the playing file.
Left (Press twice or more.): Returns to previous files.

Fast Forward/Rewind

You can fast forward or rewind the track that is currently playing.

1 Hold down  or  for 1 or more seconds.

- To the right:
Fast forwards a track.
To the left:
Rewinds a track.
Fast-forwards (rewinds) until finger is removed from switch.

Finding Desired Music File

IMPORTANT

- To continue playing a desired track or file, turn the Scan function OFF.
- The entire disc is scanned once, and normal playback starts from the position where you started to scan.
- When you have selected any of scan, folder scan, repeat, folder repeat, random or folder random, a corresponding message of Scan, F.Scan, Repeat, F.Repeat, Random or F.Random will appear to allow you to confirm the selected function.

1 Touch **Scan** to perform a scan.
Touch and hold for at least 1 second to perform a folder scan.

- Scan: Plays the first 10 seconds of each track contained in the same folder layer as the current file.
Folder scan: Plays the first 10 seconds of each folder.
- When you touch **Scan**, the current track continues to play.



Repeating Music File

IMPORTANT

When you have selected any of scan, folder scan, repeat, folder repeat, random or folder random, a corresponding message of Scan, F.Scan, Repeat, F.Repeat, Random or F.Random will appear to allow you to confirm the selected function.

1 Touch **Repeat** for repeat. Touch and hold for at least 1 second for folder repeat.

- Repeat: Repeats the current file.
Folder repeat: Repeats files of the current folder.
- Touch **Repeat** again to cancel repeating.



Random Play

IMPORTANT

When you have selected any of scan, folder scan, repeat, folder repeat, random or folder random, a corresponding message of Scan, F.Scan, Repeat, F.Repeat, Random or F.Random will appear to allow you to confirm the selected function.

1 It will perform Random playback by touching **Random**, and F.Random playback by touching it for over 1 second.

- F.Random playback: Plays files of all folders in random order.
Random playback: Plays files of currently playing folder in random order.
- Touch **Random** to continue the random play until you cancel it. Touch **Random** again to cancel the random play.
- If you touch **Repeat** during random play, the current track is repeated. When you touch **Repeat** again, random play restarts.



Using MP3/WMA Player

About MP3/WMA

MP3 (MPEG Audio Layer 3) is a standard format for audio compression. By using MP3, a file can be compressed to one-tenth the size of the original.

WMA (Windows Media™ Audio) is the Microsoft's voice compression technology. WMA files can be compressed to a size smaller than MP3 files.

This receiver only accepts certain MP3/WMA file standards, recorded media and formats. Use the following notes when you write MP3/WMA files on a disc.

■ About supported MP3 file standards

- Supported standards:
 - MPEG Audio Layer 3 (=MPEG1 Audio Layer III, MPEG2 Audio Layer III, MPEG2.5 Audio Layer III)
- Supported sampling frequencies:
 - 8, 11.025, 12, 16, 22.05, 24, 32, 44.1, 48 (kHz)
- Supported bit rates:
 - 8, 16, 24, 32, 40, 48, 56, 64, 80, 96, 112, 128, 144, 160, 192, 224, 256, 320 (Kbps)
 - * Supports VBR.
 - * Does not support free format.
- Supported channel modes:
 - Stereo, Joint Stereo, Dual channels, Monaural

■ About supported WMA file standards

- Supported standards:
 - WMA Ver. 9 Standard Decoder Class 3 satisfied
- Supported sampling frequencies:
 - 22.05, 32, 44.1, 48 (kHz)
- Supported bit rates:
 - 20, 22, 32, 36, 40, 44, 48, 64, 80, 96, 128, 160, 192, 256, 320 (K bps)
 - * Only 2-channel play is supported.
 - * Supports VBR. (5 to 320 Kbps)
 - * Does not support lossless compression.

■ About ID3/WMA tags

In MP3/WMA files, you can enter textual attribute information known as ID3 tag/WMA tags and save information such as track titles and artist names.

This receiver supports ID3v.1.0 and ID3v.1.1 tags. This receiver supports the ISO 8859-1 codes only. Use only the ISO-8859-1 codes to record tags. If characters not included in ISO-8859-1 codes are recorded, they may not be readably displayed.

This receiver supports the WMA tag ASF revision (v1.20.02). WMA tags having only Unicode are supported. Always use Unicode characters to enter the information.

■ About supported media types

You can play MP3/WMA files recorded on a CD-ROM, CD-R or CD-RW disc. Compared to CD-ROM media commonly used for music discs, CD-R and CD-RW discs are fragile in high temperature/high humidity environments and one section of the CD-R/CD-RW may become incapable of playback. Fingerprints or scratches on the disc may prevent playback or cause skipping during playback.

Sections of CD-R/CD-RW may deteriorate if left inside a vehicle for long periods of time.

We recommend that you store UV-sensitive CD-R and CD-RW discs in shield cases.

■ About format of discs

You can use discs of the following formats on the player.

- CD-ROM formats:

- CD-ROM Mode 1, CD-ROM XA Mode 2 (Form 1)

- File formats:

- ISO9660 Level 1 or Level 2

- ROMEO system, JOLIET system

MP3/WMA files recorded in a format other than the one described above may result in files that cannot be played normally and in file names and folder names that do not display properly.

In addition to these standards, the following limitations apply.

- Maximum number of directory layers:

- 8 layers

Using MP3/WMA Player

- Maximum number of characters for folder and file names:
30 characters (including delimiter “.” and 3 characters of file extension) for MP3, but 15 characters (including delimiter “.” and 3 characters of file extension) for WMA.
- Supported characters for folder and file names:
A to Z, 0 to 9, and underscore (_)
- Number of files that can be stored on a single disc:
999 files
- Number of folders that can be stored on a single disc:
255 folders

[A configuration example of MP3/WMA supporting CD]

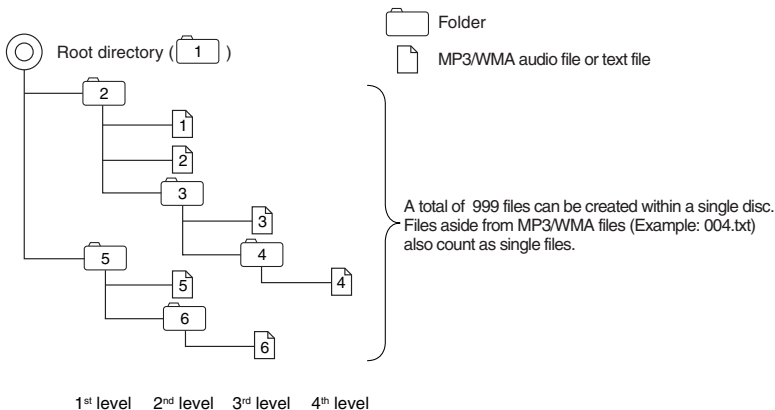

■ About file names

Only a file with the “mp3” or “wma” extension is recognized as an MP3 or WMA file. Always save an MP3/WMA file with the “mp3”/“wma” extension.

The “mp3” or “wma” file extension must be single-byte uppercase letters.

ATTENTION

If a non-MP3/WMA file has the “mp3” or “wma” file extension, it may be recognized erroneously as an MP3/WMA file. When such file is played, noise of large magnitude is output and speakers may be damaged. Do not save a non-MP3/WMA file with the “mp3” or “wma” extension.

■ Multi-sessions

Multi-sessions are supported and CD-R/RW with recorded MP3/WMA files can be played. When written with Track at once, however, finalize the disc with session close or write protect.

■ About playing MP3/WMA

When you load a disc with MP3/WMA files, the system first checks all files recorded on the disc. If the disc has many files and folders, the system may take a certain time to check them.

While the system is checking the disc, the music that was playing continues to play.

To allow quick checking of files, we recommend that you do not save non-MP3/WMA files or create unnecessary folders on the disc.

Also, we recommend that you write the all data in a single session as the system takes a longer time to read the CD control information of a multi-session disc.

■ About MP3/WMA playing time display

It is possible that playing time will not be correct, depending on the writing condition of the MP3/WMA file.

* It is possible that playing time will not be correct when VBR Fast Up/Down is operated.

Creating and Playing MP3/WMA Files

The making of MP3/WMA files by recording from sources such as broadcasts, records, recordings, videos and live performances without permission from the copyright holder for uses other than personal enjoyment is prohibited.

■ Downloading from MP3/WMA music sites on the Internet

You can find various types of MP3/WMA music distribution sites including online shopping, trial listening, and free download sites on the Internet. You can download music files from these sites by following their payment and other downloading rules.

Using MP3/WMA Player

■ Converting music CD into MP3/WMA files

Prepare a PC and a commercially available MP3/WMA encoder (conversion) software (some of them are free). Load a music CD on the PC's CD-ROM drive and compress the music CD by following the procedure of MP3/WMA encoder software. MP3/WMA-format music data files are created. A 12 cm music CD (having a maximum of 74 minutes of recording/650 MB of data) can be compressed to 65 MB (about 1/10 of the original size).

■ Writing MP3/WMA files on CD-R/RW disc

MP3/WMA files can be recorded on CD-R/RW by using a CD-R/RW drive connected to a computer. Record by setting the recording format of the recording software to ISO9660 level 1 or level 2 (not including extension format).

Select CD-ROM (mode1) or CD-ROM XA (mode2) for the disc format.

■ Playing back CD-R/RW

Insert a CD-R/RW disc having recorded MP3/WMA files. When you load a disc, the system automatically determines whether it is a music CD or a CD-R/RW disc having MP3/WMA files and plays it correctly. However, depending on the type of disc being used, the disc may not play.

CAUTION

- The 128K bps fixed bit rate and 44.1-kHz sampling frequency are recommended for high quality sound on playback.
- Note that some CD-R and CD-RW discs may not be read due to their characteristics.
- There are many types of MP3/WMA encoding software available, including commercial and freeware programs. Depending on the condition of the encoder and the file format, audio quality may deteriorate, noise may be generated when playing starts and some recordings may not play.
- When files other than MP3/WMA files are recorded on a disc, the system may take some time to recognize the disc and it may not play the disc.

Using USB Music File Player

Using USB Music File Player

This receiver can play music files stored in a USB memory. Only MP3/WMA playback is available.



- ① Folder/file selection switch
- ② File UP/DOWN, Fast UP/DOWN button
- ③ MENU button
- ④ Scan switch
- ⑤ Random switch
- ⑥ AV button
- ⑦ Repeat switch
- ⑧ List switch

Playing USB Music Files

⚠ CAUTION

Connect the USB cable correctly so that it does not interfere with safe operation of the vehicle.

⚠ IMPORTANT

When a USB memory device is attached, the receiver may take time to scan and read the file tag information. To shorten this scan time, try to store only MP3/WMA files in the USB memory and reduce the number of folders in the USB memory.

1 Connect the USB memory to the USB connector.

2 Press **MENU**.

3 Touch **USB**.

● Playback will begin.



Using USB Music File Player

Selecting Desired Folder

You can select a desired folder from the USB memory.

Selecting from folder list

1 Touch **List**.



2 Touch **Play**.

- Plays first track in folder.
- When the following screen is displayed, touch **▲** or **▼** to change between items.
- Touch **↶** to return to the immediately preceding screen.



Select from linked folders

1 Press **⏪** or **⏩**.

- **⏪**: Goes to folder one level higher and plays the first track in this folder.
- **⏩**: Goes to folder on level lower and plays the first track in this folder.



ATTENTION

If no MP3 files exist in the folder, "NO DATA" will appear in the section where the file name and folder name are displayed.

Selecting Desired Music File

You can select a track you want to play.

Selecting from file name switch

1 Touch **List**.



2 Select the folder you wish to use.

- When the following screen is displayed, touch **▲** or **▼** to change between items.
- Touch **↶** to return to the immediately preceding screen.



3 Touch the file you wish to play.

- This plays the selected music file.
- When the following screen is displayed, touch **▲** or **▼** to change between items.
- Touch **↶** to return to the immediately preceding screen.



Select from linked files



1 Press **▶▶** or **◀◀**.

- To the right:
Advances to the next file.
- To the left:
Returns to the previous file.
- The selected track (file) will be played.

Using USB Music File Player

Fast Forward/Rewind

You can fast forward/rewind the track currently being played.

- 1 Hold down  or  for 1 or more seconds.

- To the right:
Fast forwards a track.
To the left:
Rewinds a track.
Fast-forwards (rewinds) until finger is removed from switch.

Finding Desired Music File

CAUTION

- When you have selected any of scan, folder scan, repeat, folder repeat, random or folder random, a corresponding message of Scan, F.Scan, Repeat, F.Repeat, Random or F.Random will appear to allow you to confirm the selected function.
- If you disconnect the USB memory from this receiver when a music file from the USB memory is being played, this receiver returns to the previous operation mode.

- 1 Touch **Scan** to perform a scan.
Touch and hold for at least 1 second to perform a folder scan.

- Scan: Plays first 10 seconds of every file in the same folder layer as the file being played.

Folder scan: Plays the first 10 seconds of the first file of each folder.



Repeating Music File

- 1 Touch **Repeat** for repeat. Touch and hold for at least 1 second for folder repeat.

- Repeat: Repeats the current file.
Folder repeat: Repeats files of the current folder.
- Touch **Repeat** once to repeat the selected music file until the repeat function is cancelled. Touch **Repeat** again to cancel the repeat.



Random Play of Music Files

1 It will perform Random playback by touching **Random**, and F Random playback by touching it for over 1 second.

- F Random playback: Plays files of all folders in random order.
Random playback: Plays files of currently playing folder in random order.
- Touch **Random** to continue the random play until you cancel it. Touch **Random** again to cancel the random play.
- If you touch **Repeat** during random play, the current track is repeated. When you touch **Repeat** again, random play restarts.



About USB Devices

■ About supported USB memory standards

- Supported file format:
FAT 12/16/32
- Supported audio format:
MP3/WMA
- Maximum current:
500 mA
- Compatibility:
USB 1.1/2.0 (MAX transfer rate is equal to USB 1.1)

- Mass memory support:
USB mass storage (such as an external HDD) is supported.

■ Supported MP3 file standards

- Supported standards:
MPEG-1, MPEG-2, and MPEG-2.5
- Supported sampling frequencies:
MPEG-1: 32, 44.1
MPEG-2: 16, 22.05, 24
MPEG-2.5: 8, 11.025, 12
- Supported bit rates:
8 to 320 Kbps
 - * Supported VBR (8 to 320 Kbps)
 - * Does not support free format.
- Supported channel modes:
Monaural, Stereo, Joint Stereo, Dual-Channel
- USB hub and multi card reader are not supported.

■ ID3 tags

MP3 files have an "ID3 Tag" that allows information to be entered so that data such as a track title and artist can be saved.

This receiver supports ID3v. 1.0, 1.1, 2.2, 2.3 and 2.4.

Using USB Music File Player

■ Format of USB memory

The following explains the definitions of these standards.

- Maximum number of directory layers:
8 layers
- Maximum number of characters for file names:
Up to 254 characters (Total of folder name, file name, ".", and 3-character file extension)
- File name characters that you can use:
A to Z, 0 to 9, and underscore (_)
(Range of alpha-numeric ISO-8859-1)
- Max number of files that can be stored in a single memory:
3000 files

001.mp3
002.mp3
003.mp3
004.txt
005.mp3
⋮
1498.mp3
1499.mp3
⋮
2000.mp3

A total of 3000 files can be created within a single USB memory. Files aside from MP3/WMA files (Example: 004.txt) are included in the 3000 files.

Before Using the DVD Player

This receiver can play high quality images and high quality digital sound of DVD videos. Also, you can select any of languages (such as dubbing and subtitles) recorded on the DVD by switching the video and audio channels. If the same scene is recorded in different angles, you can select an angle and play the video in the desired angle.

Advantages of Digital Versatile Disc (DVD)

■ Multi-Audio Function

Some DVDs support the multi-audio function that enables you to use multiple languages and change the audio language to the desired one.

* The user's ability to change the audio language depends on the DVD.



■ Multi-Angle Function

Some DVDs support the multi-angle function that enables you to play the same video scene with multiple angles and change to the desired angles while playing.

* The user's ability to view multiple video angles depends on the DVD.

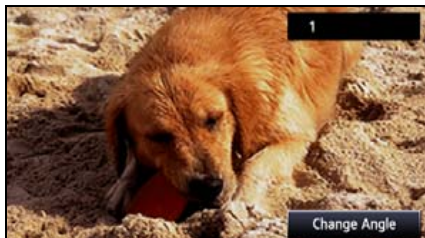

● The video angle changes.

■ Subtitle Display Function

Some DVDs support the multi-subtitle display function that enables you to change the subtitle language to the desired one while playing. If necessary, you can disable the subtitle function to play a video.

* The user's ability to display subtitles depends on the DVD.





Before Using the DVD Player

Discs

■ Types of Playable Discs

This equipment conforms to NTSC color television methods, so please use discs that display “NTSC” on the disc or package. This equipment cannot play discs using color television methods other than NTSC (such as PAL, SECAM).

Type and mark of playable disc	Size/playing side	Max. playing time
	12cm/1 side	<MPEG 2 system>
	1 layers	133 min.
	2 layers	242 min.
	12cm/2 sides	<MPEG 2 system>
	1 layers	266 min.
	2 layers	484 min.

ATTENTION





The playback status may be determined in response to the DVD or software creator's intention. This receiver plays disc contents intended by the software creator; therefore, functions may not operate as you intend. Be sure to read the user's guide that comes with the disc to be played.

■ Region Code of Playable Disc

 (region code), which is indicated on some DVDs, represents areas they can be played in. This receiver cannot play discs that do not have “1” or “ALL” indicated on this mark. If you attempt to play such a disc, the message “Region code error” will appear. Note also that some discs may be subject to regional restrictions, meaning that this receiver will not play them, even though they list or state a region code.

■ Mark Indicated on Disc

The following table shows the marks that are indicated on DVDs or packages.

Mark	Meaning
	Indicates the number of audio tracks.
	Indicates the number of subtitles.
	Indicates the number of angles.
	Indicates the image aspect ratio (ratio between the height and width of the TV screen) able to be selected. ● "16:9" indicates a wide screen, and "4:3" indicates a standard screen.
	Indicates by use of a number regions where the disc can be played. ● "ALL" indicates that the disc can be played anywhere in the world, and the number indicates a region code. "1" is the region number for North America.

■ Disc Configuration

The videos and tracks recorded on a DVD are divided into sections.

A large section is referred to as a title, to which a title number is assigned. A title is divided into chapters, to which chapter numbers are assigned.

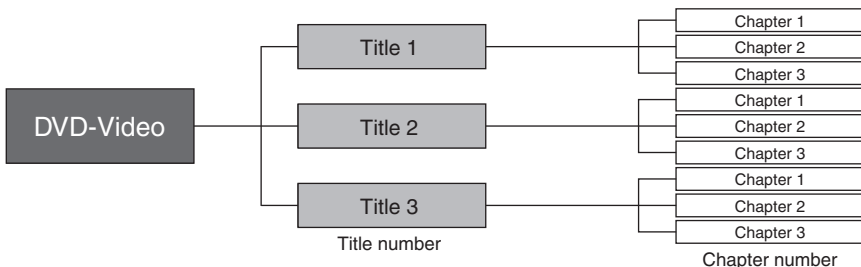

Before Using the DVD Player

Products equipped with Macrovision

This receiver is equipped with copyright protection technology that is protected under U.S.A. patents and other intellectual property rights, which are held by Macrovision Corporation or other rights holders. Using the copyright protection technology requires the permission of Macrovision Corporation, and the technology must be used only in general households and other limited viewing environments, except when expressly permitted by Macrovision Corporation. Remodeling or disassembly of this machine is prohibited.

Operation Flow

The section explains how to operate the DVD player or search for images or default settings.

- Touching touch switches displays the operation screens shown below.

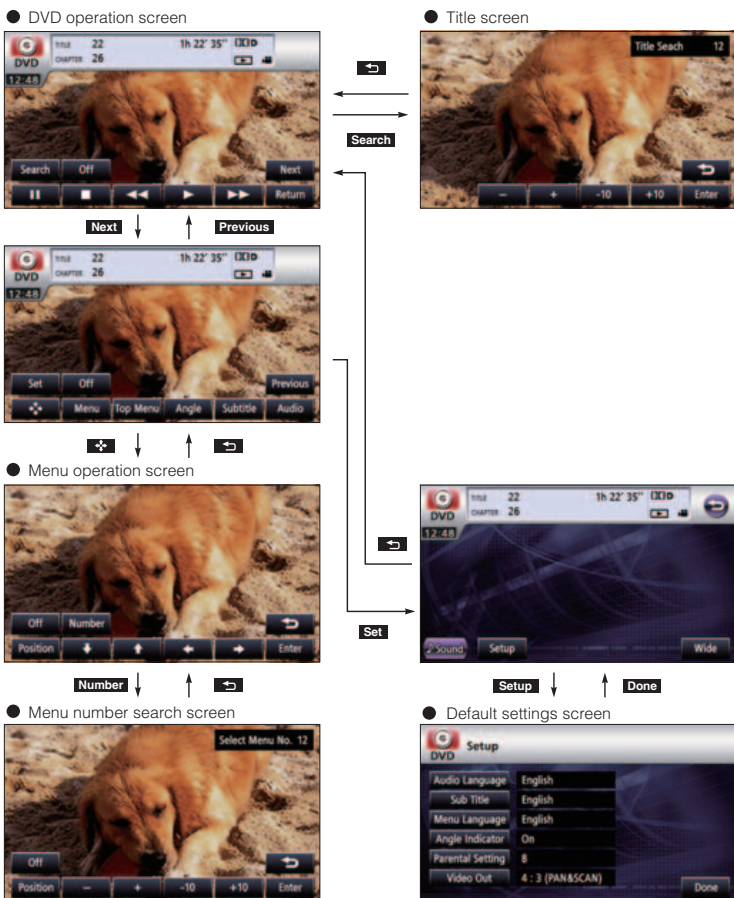

Using the DVD Player

Using the DVD Player

IMPORTANT

To ensure driving safety, you cannot watch a video while driving.

CHECK

You can watch a video on a DVD only when you have stopped your vehicle and applied the parking brake for safety reasons while the engine switch or ACC is turned on. (If the source is switched to the DVD player while the car is moving, only the audio function becomes active.)



- ① Chapter switch/fast forward (rewind) button
- ② MENU button
- ③ AV switch

Watching a DVD Video

Insert a DVD into the disc slot, and it will start playing.

1 Press **MENU**.

2 Touch **DISC**.

- The disc starts to play.
- If the operation switches (touch switches) are not being displayed, touch the screen.
- If you try to play an unsupported DVD, "Cannot read disc. Please check disc." appears.
- If the travel is regulated, a DVD is automatically played on the rear monitor after 5 seconds has elapsed in the DVD mode.



Using the DVD Player

Video Operations

IMPORTANT

- The touch switches and other operation icons are shown approximately 6 seconds. Touching the screen will display them again.
- Depending on the disc, automatic playback may not function, or playback may not function unless a menu recorded on the disc is selected. (See page 179)

■ Playing a Video



- 1 Touch .



■ Fast Forward/Rewind



It is possible to fast forward or rewind through the video being played.

Fast Forwarding or Rewinding Using Panel Switch

- 1 Hold down  or  for 1 or more seconds.

- To the right:
Fast forwards a video.
- To the left:
Rewinds a video.
- It will fast forward (rewind) the video until the switch is released.

Fast Forwarding or Rewinding Using Touch Switches



- 1 Hold down  or  for 1 or more seconds.

- It will fast forward (rewind) the video until the switch is released.



■ Pausing a Video

- 1 Touch .

- When video is paused () and when you short touch , the Slow Play starts. When you touch , the frame-by-frame play starts.



■ Stopping a Video

1 Touch .



Disc Menu Operations

You can operate the menu recorded on the disc.

1 Touch **Next**.



2 Touch .



3    Touch , and select the play-back menu.



4 Touch **Enter**.

ATTENTION

- Display menu by touching **Menu** or **Top Menu**.
- The recorded menu items vary depending on the disc. This machine plays what is recorded on the inserted disc; therefore, functions may not operate as intend.

Finding a Desired Video

You can search for the desired video with a title, chapter, or menu number (number assigned for each content).

■ Finding by Chapter

1 Press  or .

- To the right:
When selecting the next chapter.
To the left:
When selecting the cue or previous chapter.

Using the DVD Player

■ Finding by Title Number

1 Touch **Search**.



2 Touch **-**, **+**, **-10**, or **+10**, and enter the title number.

- If you touch **-** or **+**, the title number is decremented or incremented by 1.
- If you touch **-10** or **+10**, the title number is decremented or incremented by 10.



3 Touch **Enter**.

■ Finding by chapter number

1 Touch **Next**.



2 Touch **+**.



3 Touch **Number**.



4 Touch **-**, **+**, **-10**, or **+10**, and enter the menu number.

- If you touch **-** or **+**, the menu number is decremented or incremented by 1.
- If you touch **-10** or **+10**, the menu number is decremented or incremented by 10.



5 Touch **Enter**.

Changing the Touch Switch Display

You can change or hide the touch switch display while playing.

■ Hiding the Touch Switch

1 Touch **Off**.

- Touching the screen will display the touch switches again.



■ Relocating the Touch Switch Display

1 Touch **Next**.



2 Touch **+**.



3 Touch **Position**.

- The touch switch display moves up or down each time you touch them.



Using the DVD Player

Changing the Screen Display and Audio Mode

You can change the subtitle language, audio language, or display angle of a video to be played.

■ Changing the Angle

If the target disc supports multiple angles, you can change them to display a video.

CHECK

While the multi-angle mark is displayed on the screen, you can change the currently displayed angle.

1 Touch **Next**.



2 Touch **Angle**.



3 Touch **Change angle**.

- Each time you touch **Change angle**, the angle number is changed, and the angles recorded on the disc are toggled in sequence.

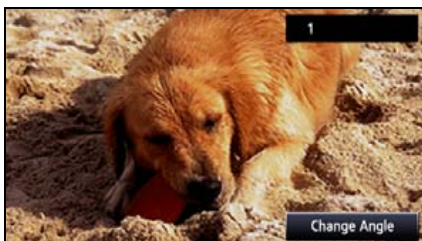

■ Changing the Subtitle Language

If the target disc supports multiple subtitle languages, you can change them to display a video.

IMPORTANT

Depending on the disc, it may only be possible to change subtitle languages from the top menu.

1 Touch **Next**.



2 Touch **Subtitle**.



3 Touch **Change subtitle**.

- Each time you touch **Change subtitle**, the subtitle number is changed, and the subtitle languages recorded on the disc are toggled in sequence.



■ Changing the Audio Language

If the target disc supports multiple audio languages, you can change them while playing.

▲ IMPORTANT

- Depending on the disc, it may only be possible to change audio languages from the top menu.
- This receiver does not support the dts (digital theater system) format; therefore, no audio will be emitted when "dts audio" is selected for a disc that contains dts audio. If audio is securely recorded on the DVD video with no audio emitted, select "Dolby Digital audio".
- dts is a registered trademark of the US company Digital Theater Systems, Inc.

1 Touch **Next**.



2 Touch **Audio**.



Using the DVD Player

3 Touch **Change audio**.

- Each time you touch **Change audio**, the audio number is changed, and the audio languages recorded on the disc are toggled in sequence.



Switching DVD setting display

1 Touch **Next**.



2 Touch **Set**.



3 Touch **Wide**.



4 Touch **Normal**, **Wide1** or **Wide2**.

- Normal**
The screen is shown with the 3 (vertical) by 4 (horizontal) aspect ratio (normal TV screen size) and side edges are black.
- Wide1**
The screen with the 9 (vertical) by 16 (horizontal) aspect ratio (normal TV screen size) is uniformly expanded in the left and right directions.
- Wide2**
The screen with the 3 (vertical) by 4 (horizontal) aspect ratio (normal TV screen size) is uniformly expanded in the up, down, left and right directions.
- It will return to previous screen by touching the ↺.



DVD Player Setting

You can pre-specify the play-back audio mode or the language used to display subtitles or menus. You can also configure settings to display or hide the multi-angle mark or specify the parental screening level.

1 Touch **Next**.



2 Touch **Set**.



3 Touch **Setup**.



4 If you touch each touch switch, you can configure the following setting.



Touch switch	Function	Page
Audio Language	Specifies the audio language of a video to be played.	186
Sub Title	Specifies the subtitle language of a video to be played.	187
Menu Language	Specifies the language used to display the menu.	188
Angle Indicator	Specifies the display of the multi-angle mark.	189
Parental Setting	Limits DVD videos that can be played.	189
Video Out	Specifies the screen size.	190

5 Touch **Done**.

Using the DVD Player

■ Specifying the Audio Language

You can watch the play-back video in the desired language.

1 Touch **Audio Language** on the initial setting screen.

2 Touch the desired language.

- If you touch **Other**, you can specify a language other than the one displayed on the screen.



3 Touch **Done**.

Entering the Code

1 Touch **Other** on the preferential audio language setting screen.

2 Enter the desired language code.

- For the language code, see “Language Code List” on page 191.



3 Touch **Done**.

- Touch  to return to the previous page.

ATTENTION

If the selected language is not compatible with the disc, you will not be able to change to that language.

■ Specifying the Subtitle Language

You can view the play-back video in the desired subtitle.

1 Touch **Sub Title** on the initial setting screen.

2 Touch the desired language.

- If you touch **Other**, you can specify a language other than the one displayed on the screen.
- If you touch **Off**, you can play a video without viewing subtitle on the screen.



3 Touch **Done**.

Entering the Code

1 Touch **Other** on the preferential subtitle language setting screen.

2 Enter the desired language code.

- For the language code, see "Language Code List" on page 191.



3 Touch **Done**.

- Touch  to return to the previous page.

ATTENTION

If the selected language is not compatible with the disc, you will not be able to change to that language.

Using the DVD Player

■ Specifying the Menu Language

You can specify the language to display menus recorded on the disc.

1 Touch **Menu Language** on the initial setting screen.

2 Touch the desired language.

- If you touch **Other**, you can specify a language other than the one displayed on the screen.



3 Touch **Done**.

Entering the Code

1 Touch **Other** on the menu language setting screen.

2 Enter the desired language code.

- For the language code, see “Language Code List” on page 191.



3 Touch **Done**.

- Touch  to return to the previous page.

ATTENTION

If the selected language is not compatible with the disc, you will not be able to change to that language.

■ Setting display of multi-angle mark

You can configure to display or hide the multi-angle mark during the playback.

1 Touch **Angle Indicator** on the initial setting screen.

- On each touch, On and Off switches.

2 Touch **Done**.

ATTENTION

When the display setting of the multi-angle mark is set to [Display], a multiple angle mark is displayed at the top of the screen whenever selection of multiple angle becomes available in the disc.

■ Specifying the Parental Screening Level

You can restrict viewing of scenes that are inappropriate for children, for example, adult-themed or violent scenes. The parental screening levels can be specified in stages depending on levels.

CHECK

This function is not available for discs that do not support the parental screening level function.

1 Touch **Parental Setting** on the initial setting screen.

2 Touch the number digit by digit to enter the code number.

- If the code number is omitted, "----" is displayed in the upper field.



3 Touch **Done**.

- Touch  to return to the previous page.

4 Touch the desired parental screening level.

- If you have entered an incorrect code number, eject the disc once, and specify the parental screening level again.



5 Touch **Done**.

Using the DVD Player

ATTENTION

- The code number is necessary. If a number is not entered, setting of viewer restriction will not be possible.
- Once a code number is specified, you must enter it when using this item next time and after. Be careful not to forget the code number. If you forget the code number, touch **Clear** 10 times while the code number field remains blank; you can initialize (clear) the current code number.
- Parental screening levels are classified into the following three types.

Level 1

Plays only DVD software created specifically for children. (Prohibits playing general and adult-themed DVD software.)

Levels 2 to 7

Plays only the general and child-friendly DVD software. (Prohibits playing adult-themed DVD software.)

Level 8

Plays all DVD software. (Default)

Switching the Video Output

1 Touch **Video Out**.

2 The screen size changes as follows each time you touch **Video Out**.

16:9 → 4:3 (LETTER BOX) → 4:3 (PAN & SCAN) → 16:9 → ...

- 16:9
Displayed with a black strip on the upper and the lower edges. DVDs recorded with the 4:3 ratio are displayed in the original ratio, which fits the screen perfectly.
- 4:3 (LETTER BOX)
Displayed in the usual wide size mode. DVDs recorded with the 4:3 ratio are displayed with a black strip on the left and the right edges or in a horizontally spread proportion.
- 4:3 (PAN&SCAN)
The left and the right edges of the video image are cropped. DVDs recorded with the 4:3 ratio are displayed in the original ratio, which fits the screen perfectly.
- The Video Out image is usually set to the output display rate. Usually use the default 16:9 ratio setting, except when you use a 4:3-ratio rear monitor display.

ATTENTION

The user should not experience any problems when watching a video on the wide screen on a personal basis. If you compress or enlarge the screen for commercial purposes or to display to the public, it may infringe a copyright that is protected by copyright laws.

Language Code List

These codes are used to specify the language for audio tracks, subtitles and on-screen menu displays.

Code	Language
1001	Japanese
0514	English
0618	French
0405	German
0920	Italian
0519	Spanish
1412	Dutch
1821	Russian
2608	Chinese
1115	Korean
0512	Greek
0101	Afar
0102	Abkhazian
0106	Afrikaans
0113	Amharic
0118	Arabic
0119	Assamese
0125	Aymara
0126	Azerbaijani
0201	Bashkir
0205	Byelorussian
0207	Bulgarian
0208	Bihari
0209	Bislama
0214	Bengali
0215	Tibetan
0218	Breton
0301	Catalan
0315	Corsican
0319	Czech
0325	Welsh
0401	Danish
0426	Bhutani
0515	Esperanto
0520	Estonian
0521	Basque
0601	Persian
0609	Finnish
0610	Fiji
0615	Faroese
0625	Frisian
0701	Irish
0704	Scots-Gaelic
0712	Galician
0714	Guarani
0721	Gujarati

Code	Language
0801	Hausa
0809	Hindi
0818	Croatian
0821	Hungarian
0825	Armenian
0901	Interlingua
0905	Interlingue
0911	Inupiak
0914	Indonesian
0919	Icelandic
0923	Hebrew
1009	Yiddish
1023	Javanese
1101	Georgian
1111	Kazakh
1112	Greenlandic
1113	Cambodian
1114	Kannada
1119	Kashmiri
1121	Kurdish
1125	Kirghiz
1201	Latin
1214	Lingala
1215	Laothian
1220	Lithuanian
1222	Latvian
1307	Malagasy
1309	Maori
1311	Macedonian
1312	Malayalam
1314	Mongolian
1315	Moldavian
1318	Marathi
1319	Malay
1320	Maltese
1325	Burmese
1401	Nauru
1405	Nepali
1415	Norwegian
1503	Occitan
1513	Oromo
1518	Oriya
1601	Panjabi
1612	Polish
1619	Pashto
1620	Portuguese

Code	Language
1721	Quechua
1813	Rhaeto-Romance
1814	Kirundi
1815	Romanian
1823	Kinyarwanda
1901	Sanskrit
1904	Sindhi
1907	Sangho
1908	Serbo-Croatian
1909	Sinhalese
1911	Slovak
1912	Slovenian
1913	Samoan
1914	Shona
1915	Somali
1917	Albanian
1918	Serbian
1919	Siswati
1920	Sesotho
1921	Sundanese
1922	Swedish
1923	Swahili
2001	Tamil
2005	Telugu
2007	Tajik
2008	Thai
2009	Tigrinya
2011	Turkmen
2012	Tagalog
2014	Setswana
2015	Tonga
2018	Turkish
2019	Tsonga
2020	Tatar
2023	Twí
2111	Ukrainian
2118	Urdu
2126	Uzbek
2209	Vietnamese
2215	Volapuk
2315	Wolof
2408	Xhosa
2515	Yoruba
2621	Zulu

Using the VTR

Using the VTR

You can watch a video by connecting a commercially available VTR. You cannot, however, connect the iPod cable (video line) and VTR together.

⚠ IMPORTANT

To ensure driving safety, you cannot watch a video while driving.

✍ CHECK

You can watch a video only when you have stopped your vehicle and applied the parking brake to secure safety while the engine switch or ACC is turned on. (When the source is switched to the VTR while the car is moving, only the audio function becomes active.)

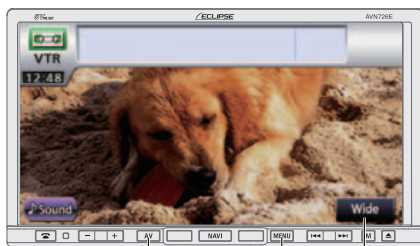

- ① Wide switch
- ② MENU button
- ③ AV button

Playing the VTR

1 Press **MENU**.

2 Touch **VTR**.

- The VTR screen appears.
- Touch the screen to change to the VTR operation screen.
- Changing to the VTR operation screen displays each touch switch for approximately 6 seconds.



📖 ATTENTION

- Whether or not the video is displayed correctly depends on the connected equipment.
- VTR mode is not available when the iPod is connected using the iPod cable (iPC-709). (iPod mode and VTR mode are in exclusion relationship) To use the VTR mode, disconnect the iPod cable before using.

Changing the VTR Setting Screen

1 Touch **Wide**.

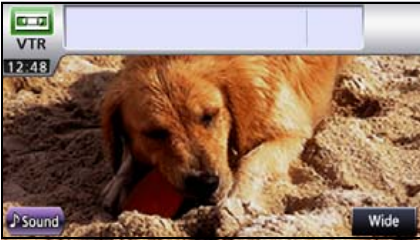

2 Touch **Normal**, **Wide1** or **Wide2**.

● **Normal**

The screen is shown with the 3 (vertical) by 4 (horizontal) aspect ratio (normal TV screen size) and side edges are black.

● **Wide1**

The screen with the 9 (vertical) by 16 (horizontal) aspect ratio (normal TV screen size) is uniformly expanded in the left and right directions.

● **Wide2**

The screen with the 3 (vertical) by 4 (horizontal) aspect ratio (normal TV screen size) is uniformly expanded in the up, down, left and right directions.

- It will return to previous screen by touching the .



Using the DivX Player

Using the DivX Player

IMPORTANT

To ensure driving safety, you cannot watch a video while driving.

■ About DivX

- DivX is a highly recognized media technology developed by DivX, Inc. DivX media files enable you to compress with a high compression ratio while maintaining high image quality. Menus, sub titles, and sub audio tracks can be included in the file compressed by DivX. DivX.com has a variety of DivX media files. It is possible to create original contents by downloading these media and using the DivX dedicated tools.

■ About DivX Certified

- DivX Certified products have been tested by the DivX creators, and have been officially tested and certified that they can be played back on all versions of DivX (including DivX 6). A DivX Certified logo on products shows that it is a portable video or HD video that complies with the DivX Profiles Standard.



- DivX, DivX Certified and related logos are trademarks of DivX, Inc. These trademarks are used with the permission of DivX, Inc.
- This unit supports playback of DivX files recorded onto disc. It does not support the playback of the video file in the USB memory.
- For safety, only DivX music can be played back while the vehicle is in motion.

CHECK

You can watch a DivX only when you have stopped your vehicle and applied the parking brake to secure safety while the engine switch or ACC is turned on. (If the source is switched to the DivX player while the vehicle is in motion, only the audio function becomes active.)



- ① Set switch
- ② File switch/fast forward (rewind) button
- ③ MENU button
- ④ Folder / file selection switch
- ⑤ Random switch
- ⑥ AV button
- ⑦ Repeat switch
- ⑧ Playback / pause switch
- ⑨ List switch

Playing the DivX

Insert a disc containing a DivX file into the disc slot, and it will start playing.

1 Press **MENU**.

2 Touch **DISC**.

- The disc starts to play.
- If the operation switches (touch switches) are not being displayed, touch the screen.



Video Operations

▲ IMPORTANT

The touch switches and other operation icons are shown approximately 6 seconds. Touching the screen will display them again.

Fast Forward/Rewind

It is possible to fast forward or rewind through the file being played.

1 Hold down **▶▶** or **◀◀** for 1 or more seconds.

- To the right:

Fast forwards a video.

To the left:

Rewinds a video.

When a beep sounds, the fast forward (or rewind) mode starts and the video is fast forwarded (or rewound) until you remove your finger from the switch.

Pausing a Video

1 Touch **||**.



Using the DivX Player

Select the folder to view



You can select a desired folder from the disc.

Select from the folder list

1 Touch **List**.





2 Touch **Play**.

- Playback the video at the start of the folder.
- Page will switch by touching  or  if there is next page.
- It will return to previous screen by touching the .



Select from continuous folder

1 Press  or .

-  : Goes to the next higher folder and plays the first video of this folder.
-  : Goes to the next lower folder and plays the first video of this folder.



ATTENTION

If there is no file in folder, "NO DATA" is displayed instead of file name and folder name.

Select the file to view

You can select a desired file from the folder.

Select from file name switch

1 Touch **List**.



2 Touch on the folder to view.

- Page will switch by touching ▲ or ▼ if there is next page.
- Touch ↶ to return to the immediately preceding screen.



3 Touch on the file to view.

- This plays the selected file.
- Page will switch by touching ▲ or ▼ if there is next page.
- It will return to previous screen by touching the ↶.



■ Select from linked files

1 Press ⏮ or ⏭.

- Right: Advances to the next file.
Left (Press once.): Returns to the beginning of the playing file.
Left (Press twice or more.): Returns to previous files.

Fast Forward/Rewind

You can fast forward or rewind the currently playing video.

1 Hold down ⏩ or ⏪ for 1 or more seconds.

- To the right:
Fast forwards a video.
To the left:
Rewinds a video.
It will fast forward (rewind) the video until the switch is released.

Repeating a video file

⚠ IMPORTANT

When you select repeat, folder repeat, random, or folder random, its function is shown as Repeat, F.Repeat, Random, or F.Random on the display.

1 Touch **Repeat**.

- Repeat the file currently being viewed.
- Touch **Repeat** again to cancel repeating.



Using the DivX Player

Random Play

⚠ IMPORTANT

When you select repeat or random, its function is shown as Repeat or Random on the display.

1 Touch **Random**.

- Plays files of currently playing folder in random order.
- When you touch **Random**, the random play continues until you cancel it. When you touch **Random** again, the random play is cancelled.
- If you touch **Repeat** during random play, the current video is repeated. When you touch **Repeat** again, random play restarts.



Changing the Subtitle Language

If the target disc supports multiple subtitle languages, you can change them to display a video.

1 Touch **Set**.



2 Touch **Subtitle**.

- Touch  to return to the immediately preceding screen.



3 Touch **Change Subtitle**.

- Each time you touch **Change Subtitle**, the subtitle number is changed, and the subtitle languages recorded on the disc are toggled in sequence.



Changing the Audio Language

If the target disc supports multiple audio languages, you can change them while playing.

1 Touch **Set**.



2 Touch **Audio**.

- Touch  to return to the immediately preceding screen.



3 Touch **Change Audio**.

- Each time you touch **Change Audio**, the audio number is changed, and the audio languages recorded on the disc are toggled in sequence.



Using the DivX Player

Display DivX VOD code

To play the DivX VOD (Video On Demand) contents, register this unit to the contents provider first. This DivX VOD registration code is required at that time.

DivX® Video On Demand registration code can be displayed.

1 Press **MENU**.

2 Touch **Info**.



3 Touch **DivX VOD**.

- DivX® Video On Demand registration code is displayed.



- It will return to previous screen by touching the .



Caution display while playing VOD Rental file

A message is displayed on the screen when DivX VOD Rental files are played. Read the contents displayed, and touch either [Yes] or [No].

Switching the Video Output

1 Touch **Set**.



2 Touch **Wide**.

- Touch  to return to the immediately preceding screen.



3 Touch **Normal**, **Wide1** or **Wide2**.

- **Normal**

The screen is shown with the 3 (vertical) by 4 (horizontal) aspect ratio (normal TV screen size) and side edges are black.

- **Wide1**

The screen with the 9 (vertical) by 16 (horizontal) aspect ratio (normal TV screen size) is uniformly expanded in the left and right directions.

- **Wide2**

The screen with the 3 (vertical) by 4 (horizontal) aspect ratio (normal TV screen size) is uniformly expanded in the up, down, left and right directions.

- It will return to previous screen by touching the .



ATTENTION

The user should not experience any problems when watching a video on the wide screen on a personal basis. If you compress or enlarge the screen for commercial purposes or to display to the public, it may infringe a copyright that is protected by copyright laws.

Using the DivX Player

About DivX

■ About the DivX standards that can be played back

Format of Discs

- CD-ROM formats:
CD-ROM Mode 1, CD-ROM XA Mode 2 (Form 1)
- File formats:
ISO9660 Level 1 or Level 2 (for both CD and DVD)
ROMEO system, JOLIET system
MP3/WMA files recorded in a format other than the one explained above may result in files that cannot be played normally and in file names and folder names that do not display properly.

Limitations in addition to standards are as follows.

- Length of folder/file name:
64 bytes
- Playable extensions:
DivX, Div, AVI (single byte characters only, not case-sensitive)
- File structure:
8 layers max
- Folder volume in the disk (including root):
256 max
- Folder and file volume in the disk folder (including root):
999 max
- Standard level:
DivX Certified *1

- Codec support:
DivX 3.x, 4.x, 5.x, 6.x
- Profile:
Home Theater *2
- Maximum resolution:
720×480 (30fps), 720×576 (25fps)
- Supported audio codec:
MP3, AC3, MPEG, LPCM

*1 Only title 1 can be played back in DivX media format. Menu is not displayed.

*2 High bit rate stream recorded on the CD might not have a sufficient data transfer rate. It is recommended to record to DVD in such a case.

Using the iPod® Player

Using the iPod Player

Once an iPod is connected, you can play iPod music or video files. Using this receiver, you can perform operations, for example, selecting a file from the list or changing to the random playback mode. You cannot, however, connect the iPod cable (video line) together with USB or VTR.

IMPORTANT

- For details on the iPod functions, refer to the iPod operation manual.
 - It is assumed here that the iPod has already been connected to this main unit with an optional iPod interface cable (iPC-709).
 - See the ECLIPSE Website (<http://www.eclipse-web.com/us/ipodcompatibility/index.html>) for details on applicable phone models.
 - To ensure driving safety, you cannot watch a video while driving.
- iPod is a trademark of Apple Inc., registered in the U.S. and other countries.



- ① Shuffle All switch
- ② File UP/DOWN, Fast UP/DOWN button
- ③ Album Shuffle switch
- ④ MENU button
- ⑤ Shuffle switch
- ⑥ Repeat switch
- ⑦ AV button

- ⑧ Menu switch
- ⑨ List switch

Listening to the iPod

CAUTION

- Disconnect headphones and other accessories from the iPod before connecting it to this receiver. Failure to do so may make it impossible to operate the iPod from this receiver.
- If the iPod's equalizer has been preset, sound output may be distorted when it is connected to the optional dedicated connection cable.
- If this receiver does not support the language used in iPod, album names, titles, and artist names are displayed as blank.
- iPod may not be recognized by ACC OFF/ON. In such a case, remove the iPod once, and reconnect it.

IMPORTANT

When you attach your iPod, the music restarts from the stopped position. If you switched the power of the iPod ON/OFF, the music restarts from the stopped position.

But if the receiver cannot detect the music file that was playing previously, it will begin playing from the first music file.

Using the iPod® Player

1 Press **MENU**.

2 Touch **iPod**.

- Playback will begin.



Fast Forward/Rewind

You can fast forward or rewind the track or the video currently being played.

1 Hold down **▶▶** or **◀◀** for 1 or more seconds.

- To the right:
Forwards a track or video file.
To the left:
Rewinds a track or video file.
It will fast forward (rewind) the video until the switch is released.

Selecting the Desired Music or Video File

You can select a desired song or video.

1 Press **▶▶** or **◀◀**.

- To the right:
Advances to the next file.
To the left:
Returns to the beginning of the file being played.
Left (Press more than two times):
Returns to the previous file.
The selected song or the video (file) will be played.

Finding a Desired Music File

CAUTION

If the iPod is disconnected from this receiver while playing a music file on the iPod, you will return to the previously selected mode.

1 Touch **Menu**.



2 To select a track or program to play, touch **Playlists**, **Artists**, **Albums**, **Podcasts**, or **Genres**.

- This displays the list screen of the selected mode.
- Touch  to return to the immediately preceding screen.



3 Touch the list to listen.

- Repeat until the track screen is displayed. The order depends on the selection modes as follows.

Playlist:

Playlist → track screen

Album:

Album screen → track screen

Artist:

Artist screen → album screen → track screen





Podcasts:

Podcasts screen → Podcasts screen → track screen

Genre:

Genre screen → artist screen → album screen → track screen

4 Touch the name of the music file to be played.

- This plays the selected music file.
- When  or  appears, touch them to change the page of the music file list.
- You cannot operate the  and  switches when your car is running.
- Music file in the list is played from the beginning by touching the **Play**.
- Touch **Menu** and the menu screen is displayed.
- Touch  to return to the immediately preceding screen.



View the list of playing back

1 Touch **List**.



Using the iPod® Player

Setting to the iPod Video Mode

You can select and play a desired video file from the iPod memory.

CAUTION

- If the iPod is disconnected from this receiver while playing a video file on the iPod, you will return to the previously selected mode.
- Depending on the model of the iPod, a music list may be displayed on the video list.

Select the video file to view from the list

Video file to view can be selected.

1 Touch **Menu**.



2 Touch **Video**.



3 Touch on the category to view.

- Touch **Menu** and the menu screen is displayed.
- Page will switch by touching ▲ or ▼ if there is next page.
- Touch ↶ to return to the immediately preceding screen.





4 Touch on the list to view.

- Repeat until the video screen is displayed.
- Video file in the list is played from the beginning by touching the **Play**.
- Page will switch by touching ▲ or ▼ if there is next page.
- Touch **Menu** and the menu screen is displayed.
- Touch ↶ to return to the immediately preceding screen.





5 Touch on the video file to view.

- This plays the selected video file.
- Page will switch by touching  or  if there is next page.
- Touch **Menu** and the menu screen is displayed.
- Touch  to return to the immediately preceding screen.



Pausing

1 Touch .

- Touch  to pause the display. Touch  to resume playing.



Repeatedly Playing the Same Music File

1 Touch **Repeat**.

- This repeatedly plays the currently played music file.
- Once you touch **Repeat**, the selected music file will be repeated until the repeat function is released. Touch **Repeat** again to cancel the repeat play.
- The list to playback will be repeatedly played back when the Repeat is cleared.



Using the iPod® Player

Random Play of Music Files

■ Listen randomly from the list that is playing

1 Touch **Shuffle**.

- All the files will playback randomly from the playlist.
- Once you touch **Shuffle**, the random play continues until you cancel it. Touch **Shuffle** again to cancel the random playback of all files in the playlist.



■ Listen to an album randomly

The selected album can be played back randomly. However, the music files in the album will be played back in order from the beginning.

1 Touch **Album Shuffle**.

- Once you touch **Album Shuffle**, the random play continues until you cancel it. When you touch **Album Shuffle** again, the random play for the album is cancelled.



■ Listen all music files random

All music files can be played back randomly.

1 Touch **Shuffle All**.

- Once you touch **Shuffle All**, the random play continues until you cancel it. Touch **Shuffle All** again to cancel the random play.



ATTENTION

When the iPod is taken off with the unit set to Shuffle All, setting of the iPod will be changed to shuffle playback.

Using Bluetooth Audio

Using Bluetooth Audio

A Bluetooth compatible portable audio player (“portable device” hereafter) can be used as a source for this unit by utilizing the Bluetooth wireless communication technology.

To use a Bluetooth compatible portable device with this unit, it is necessary to perform Bluetooth registration and connection settings.

- The Bluetooth compatible portable device to be connected must be a portable device which supports the relevant Bluetooth specification. For the Bluetooth specification supported by this receiver, see Specification. (See page 227)
- Bluetooth is a short-range wireless technology for connecting cell phones, computers and other such devices.



Bluetooth® is a registered trademark of Bluetooth SIG, Inc.

ATTENTION

- This unit can be used with Bluetooth compatible portable devices.
- See the operation manual of the portable device regarding the operation of Bluetooth.
- The connection status may become bad and operation with this unit may not be possible for the Bluetooth audio depending on the surrounding environment.

Registration of portable devices

Register a portable device to this receiver. Portable devices can be registered in two ways, from the portable device, or by searching for the portable device on this receiver. Only one portable device can be registered to this unit.

IMPORTANT

Do not perform registration operation of the portable device while driving. Perform the registration operation after stopping the vehicle in a safe location.

Registration from the portable device

1 Press **MENU**.

2 Touch **Bluetooth Audio**.



3 Touch **Pairing**.



4 Touch **Allow Connect**.



5 On the portable device, enter PIN CODE for this receiver.

- The default PIN CODE setting is 1234.
- Perform the portable device operations with the Device information screen displayed.



- Device information screen

6 "Bluetooth Connection Successful" is displayed on completion of registration.

- Registration of the portable device is now complete.

Register by searching for a portable device on this receiver

1 Press **MENU**.

2 Touch **Bluetooth Audio**.



3 Touch **Pairing**.



4 Touch **Device Search**.

- "Searching..." is displayed.



Using Bluetooth Audio

- 5** Select the device name of the portable device you wish to register

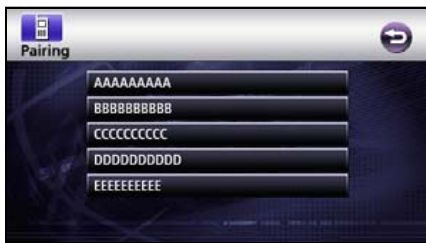

- 6** Enter the PIN CODE on the portable device.

- The default PIN CODE setting is 1234.
- Perform the portable device operations with the Device information screen displayed.



- Device information screen

- 7** “Bluetooth Connection Successful” is displayed on completion of registration.

- Registration of the portable device is now complete.

ATTENTION

- When registration fails, “Bluetooth Connection Failed” is displayed. In this case, repeat the registration operations.
- For portable device-side operations, consult the operation manual that came with your portable device.

■ Connection of the portable device

Connect a portable device registered on this receiver.

- 1** Press **MENU**.

- 2** Touch **Bluetooth Audio**.



- 3** Touch **Connect**.



- 4** “Bluetooth Connection Successful” is displayed on completion of connection.

- Connection of the portable device to this receiver is now complete.

ATTENTION

- When connection fails, “Bluetooth Connection Failed” is displayed. In this case, repeat the connection operations.
- Note that you cannot connect unregistered portable devices.

■ Cancelling a portable device connection.

1 Press **MENU**.

2 Touch **Bluetooth Audio**.



3 Touch **Disconnect**.



4 "Bluetooth Connection Successful" is displayed on completion of cancellation.

- Cancelling of the connection of the portable device is now complete.

ATTENTION

When connection fails, "Bluetooth Connection Failed" is displayed. In this case, repeat the connection operations.

■ Listening to the portable device



- ① Random switch
- ② File UP/DOWN, Fast UP/DOWN button
- ③ Repeat switch
- ④ MENU button
- ⑤ Play switch
- ⑥ AV button
- ⑦ Stop switch

1 Press **MENU**.

2 Touch **Bluetooth Audio**.



Using Bluetooth Audio

3 Touch .

- Start the playback of the connected portable device.



ATTENTION

If the playback does not start by touching the  of this unit, press the playback button on the portable device.

■ Stop the playback

1 Touch .

- To resume the playback, touch .



■ Selecting a Desired Music

1 Press or .

- Right: Advances to the next music.
Left (pressing once): Returns to the beginning of the music being played.
Left (pressing more than two times): Returns to the previous music.

■ Fast forward / rewind

1 Press or for one second or longer.

■ Repeating the Same Track

1 Touch **Repeat**.

- The track repeats to play.
- When you touch **Repeat**, the track repeats to play until you cancel it.
Touch **Repeat** again to cancel the repeat play.



■ Random Play

1 Touch **Random**.

- All titles of the Bluetooth Audio are played in random order.
- When you touch **Random**, the random play continues until you cancel it.
When you touch **Random** again, the random play is cancelled.



About the Steering Wheel Switches

On vehicles equipped with steering wheel switches, these easy-access switches can be used to perform the main audio and other operations.

- For details of the steering wheel switch, please contact your local dealer.
- This function may not be available depending on the vehicle type.

Manual setting of steering wheel switch functions

You can manually assign the desired functions to every steering wheel switch buttons.

IMPORTANT

Your manual setting may fail due to the ambient environments including the outdoor temperature.

1 Press **MENU**.

2 Touch **Info**.



3 Touch **Steering Remote Setting**.

- Audio is turned OFF when **Steering Remote Setting** is touched.



4 Touch **Manual Setting**.

- Touch  to return to the immediately preceding screen.





5 Touch **Store** until the Command Select screen is displayed.

- Touch  to return to the immediately preceding screen.



6 Touch the command you wish to set.

- Next page is displayed by touching  or .



7 While pressing the steering switch button to record, touch the **Store** until a beep sounds.

- It will display Completed when the setting is completed, then it will return to Command Select screen and displays Store on the set command.
- "Error, try once again" is displayed when the data reading fails.

- Touch  to return to the immediately preceding screen.



8 Assign the desired functions to the steering wheel switch buttons by repeating Steps 6 through 7.

9 Touch **Finalize**.



10 Touch **Done** after confirming the final confirmation screen.

- Touch  to return to the immediately preceding screen.



ATTENTION





If "Error, try once again" is shown on the display, once again select a desired function to set.

About the Steering Wheel Switches

Compatibility with Steering Wheel Switches

The table below shows the compatibility between the steering wheel switches and this receiver. (Switches other than (∧) and (∨) are available for VTR operation.)

Operation	Switch	Name	Function	Explanation of operation
Common operations	(+) (-)	Volume switch	Each momentary actuation of these switches changes the volume one step. Hold a switch down for a continuous volume change.	(+): Turns up the volume (ringtone volume and talking volume during BT-TEL). (-): Turns down the volume (ringtone volume and talking volume during BT-TEL).
	(MODE)	Mode selection switch	<ul style="list-style-type: none"> When this switch is pressed while the power is turned off, the power is turned on. The mode changes in the following order. FM/AM → SIR* → XM* → DISC (CD, DVD, MP3/WMA or DivX) → USB → BT-Audio → iPod* → VTR → return to FM/AM. 	When the power is on, the mode changes each time (MODE) is pressed.
	(POWER)	Power switch	Turn on or off the power.	Turn on or off the power by short press.
	(MUTE)	Mute	This will mute.	This will mute by short press.
Radio operations	(∧) (∨)	Channel selection switch	<ul style="list-style-type: none"> Selects the next or previous channel. Starts the automatic channel selection operation. 	Press (∧) or (∨) briefly to select the next or previous channel. Press and hold (∧) or (∨) longer to start the automatic channel selection operation.
SIRIUS/XM satellite radio tuner operations	(∧) (∨)	Channel selection switch	<ul style="list-style-type: none"> Selects the next or previous channel. Press and hold to start the automatic selection within the category. 	Press (∧) or (∨) briefly to select the next or previous channel. Press and hold (∧) or (∨) longer to start the automatic selection operation within the category.

Operation	Switch	Name	Function	Explanation of operation
CD Player Operations	(^) (v)	Track selection switches	<ul style="list-style-type: none"> ● Selects the next track or previous track or beginning of the current track. ● Fast forward or rewind 	<p>Press (^) or (v) briefly to select the next or previous track.</p> <p>Press and hold (^) or (v) longer to fast forward or rewind a track.</p>
Operation of MP3/WMA player or DivX player	(^) (v)	Track selection switches	<ul style="list-style-type: none"> ● Selects the next track or previous track or beginning of the current track. ● Fast forward or rewind 	<p>Press (^) or (v) briefly to select the next or previous track.</p> <p>Press and hold (^) or (v) longer to fast forward or rewind a track.</p>
USB operations	(^) (v)	Track selection switches	<ul style="list-style-type: none"> ● Selects the next track or previous track or beginning of the current track. ● Fast forward or rewind 	<p>Press (^) or (v) briefly to select the next or previous track.</p> <p>Press and hold (^) or (v) longer to fast forward or rewind a track.</p>
Operation of iPod and BT-Audio	(^) (v)	Track selection switches	<ul style="list-style-type: none"> ● Selects the next track or previous track or beginning of the current track. ● Fast forward or rewind 	<p>Press (^) or (v) briefly to select the next or previous track.</p> <p>Press and hold (^) or (v) longer to fast forward or rewind a track.</p>
Function DVD operations	(^) (v)	Chapter selection and fast forward or rewind switch	<ul style="list-style-type: none"> ● Selects the next or previous chapter. ● Fast forward or rewind 	<p>Press (^) or (v) briefly to select the next or previous chapter.</p> <p>Press and hold (^) or (v) longer to fast forward or rewind a chapter.</p>
Operation of the BT-TEL	 	On Hook Off Hook	<ul style="list-style-type: none"> ● End the call, or refuse the call. ● Call is made or received. ● Calls up the telephone mode. 	<p>Press  briefly to end call or refuse call.</p> <p>Press  briefly to start call or accept call. It will enter telephone mode if it is not in telephone mode.</p>

* Option

Necessary Information

If the Following Messages Appear

If the following messages appear, check the status again, referring to the cause and action.

Message	Cause	Action
In CD/MP3 WMA/DVD mode		
No DISC	DISC is not inserted.	Insert the DISC.
Check DISC	Disc is dirty or damaged.	The loaded disc is dirty or upside down. Check it for proper orientation and verify it is clean. Clean the disc if it is dirty. Insert the disc correctly if it is upsidedown. Do not use the scratched or warped disc.
No support	Disc does not have correct files.	Confirm the file.
DISC Error	The CD/MP3-WMA or DVD player is not operating for some reason.	Eject the disc.
Error	The temperature of the CD/MP3-WMA or DVD player has become unusually high.	Without performing any other operations, wait until the temperature comes down *.
Pass code incorrect	This message is displayed when the pass code that has been entered is not correct.	Enter the correct pass code.
Parental lock enabled	Viewing restrictions are enabled.	Change the setting for viewing restrictions and start again.(See page 189)
Currently this function is disabled.	A function that has been disabled was selected with the menu.	Follow the directions on the screen and start again.
Currently this function is disabled.	A function that cannot be used while the vehicle is in motion was selected.	Stop the vehicle and set the emergency / parking brake.
Invalid code	A number not supported was input for selecting a language code.	Input a valid language code.
Region code error	The region code (controlled region for playback) of the disc is not acceptable.	Check that the DVD has a region code that can be played on this equipment.(See page 174)
Requested chapter or title not found.	The selected chapter/title does not exist.	Select a chapter/title that is on the disc.
Cannot read disc. Please check	Cannot play the DVD	Eject the DISC.
During DivX mode		
Authorization Error This player is not authorized to play this video	This is copyright protected file, so the DivX file that was purchased with registration code other than this device cannot play.	Eject the DISC.

Message	Cause	Action
This file exceeds the resolution allowed by the HOME THEATER profile.	Resolution error This is a DivX file recorded with resolution other than DivX HOME THEATER profile, so it cannot play.	Eject the DISC.
View DivX(R) VOD Rental This rental has ** views left. Do you want to use one of your ** views now? [YES]/[NO]	Display the remaining playback count of the file	Follow the directions on the screen.
Rental Expired	Viewing count has expired	Eject the DISC.
Currently this function is disabled.	A function that has been disabled was selected with the menu.	Follow the directions on the screen and start again.
Currently this function is disabled.	A function that cannot be used while the vehicle is in motion was selected.	Stop the vehicle and set the emergency / parking brake.
Reading INDEX **%	File read percentage display	Do not operate until the reading of file is completed.
In USB mode		
No data	USB memory does not have correct files.	Confirm the file.
Check USB	A communication error or data transfer error is occurred.	Confirm connection with USB memory or USB memory standards. Also, reconnect the USB memory.
HD Radio mode		
SPS CH OFF	Cannot receive sub channel	Adjust to sub channel that can be received.
Storing Tag data	Tag information is stored as enabled	Please wait.
Store success Tag **/50	Storing of Tag information was success	Please wait.
Storage full Connect iPod	Number of stored memories of Tag information has reached 50.	Connect the iPod and transfer the information.
Insufficient data	Acquisition of Tag information has failed	Try to acquire again. It may not be acquired.
Transferring Tags to iPod	Transferring Tag information to the iPod	Please wait.
** Tags sent	Tag information was transferred to the iPod	Continue the operation.
No data	Tag information cannot be used	Wait until the Tag information can be used.
Failed	Transferring of Tag information to the iPod has failed	Try the operation again.
iPod full Tags cannot be stored	Memory of the iPod is full	Check the iPod.

Necessary Information

Message	Cause	Action
Linking	Cannot receive sub channel	Adjust the antenna position so it can receive the sub channels.
In SIRIUS mode		
Antenna error	The SIRIUS antenna is disconnected.	Check the connection of the SIRIUS antenna.
Acquiring signal	Displayed when the SIRIUS satellite radio signal is lost (during access)	Try receiving the signal again in the place where there are no obstacles.
Call 888-539-SIRIUS	You are tuned to a valid SIRIUS channel but you are not subscribed to that channel.	Subscribe to SIRIUS. Or, check/change your subscription plan.
Sub updated	Displayed when your SIRIUS channel subscription has been accepted and your status is being updated to allow you to receive the channels.	After this message is displayed, the channels for which you do have a subscription can be received.
Invalid channel	Displayed when you are tuned to a SIRIUS channel that you cannot receive.	Tune to channels that you can receive.
Updating	Displayed while the channel map is being updated.	After this message is displayed, subscribe to SIRIUS. The channels for which you do have a subscription can be received.
In XM mode		
Check antenna	The XM antenna is disconnected.	Check the connection of the XM antenna.
No signal	Displayed when the XM satellite radio signal is lost (during access)	Try receiving the signal again in the place where there are no obstacles.
Off air	Displayed when the XM channel you are tuned to is not currently on air.	Tune to channels currently on air.
Loading	Obtaining audio and information data for the XM channel.	Wait for a brief period.
Check XM tuner	XM tuner is not connected and cannot receive	Check the connection of the XM tuner.
Ch unavailable	Displayed when tuned to the XM channel, no permission	Tune to channels currently on air.
Ch unauthorized	Displayed when tuned to the XM channel	Adjust to the channel that can be received.
Ch unauthorized	This is displayed when the encryption code is updating	Please wait.
In iPod mode		
Error1 Communication error	Playback failed, communication problem	Reconnect the iPod.
Reading	This machine is currently detecting iPod data.	Wait for a brief period.

Message	Cause	Action
No iPod	iPod is not connected	Connect the iPod.
No data	The iPod contains neither tracks nor video.	Import a track or video file for the iPod to play.
Error2 Check iPod	A communication error, playback error, iPod software incompatibility, or control error occurred.	Connect a playable iPod. Reconnect the iPod.
No support music files	This is displayed when the music is played in Video mode of the iPod 5G	Select a playable file.

* If this happens, wait for a brief period. When the temperature inside the equipment returns to normal, the message will disappear and playback will start. If the message does not disappear after a long period of waiting, contact the place of purchase.

Necessary Information

When You Think There Is a Malfunction

A slight difference in operation may be mistaken for a malfunction. Please check the items in the following table first.

If the unit does not work, even after the appropriate remedial action has been taken, please contact your dealer.

Condition	Possible cause	Action
The screen is dark for a brief period when the power is turned on at low temperatures.	This is a characteristic of TFTs.	This is not a malfunction. Wait for a brief period.
The display is distorted for a brief period after the power is turned on.	This is a characteristic of TFT backlighting.	This is not a malfunction. The display will stabilize after a brief period.
No sound comes out.	Volume is poorly adjusted or MUTE is functioning.	Press the VOL button to adjust the volume. Or release MUTE.
	The music is muted in following cases. ● the voice guidance is ON. ● talking in the hands-free mode*	This is not a malfunction. The music can be heard again when the voice guidance finishes or the hands-free mode is turned off.
Sound comes out of only one side (left or right, front or back).	A speaker wire is disconnected.	Check the connections of the speaker wires.
	Volume is poorly adjusted.	Check the balance and fader adjustments.
Sound quality does not change even after making adjustments.	The adjusted audio quality is not included in the radio broadcast or disc.	Check by changing the radio station or disc.
A CD/DVD will not go into the deck.	Power is not turned on.	Turn the vehicle ignition switch to [ACC] or [ON].
	A disc is already inserted and you are trying to insert a second disc.	Eject the previously inserted CD/DVD and insert the preferred CD/DVD.
A CD/DVD cannot be played.	There is water condensation inside the equipment.	Stop using the equipment for a short time and then try using it again.(See page 121)
	There is a large scratch or warp in the CD/DVD.	Insert a different CD/DVD.
	The CD/DVD is very dirty.	Clean the CD/DVD.(See page 121)
	The CD/DVD is upside down.	Insert the CD/DVD with the proper orientation.
	A non-supported type of CD/DVD has been inserted.	Insert a CD/DVD that is supported in the deck.(See page 121)
Audio is output, but not DVD video. (With vehicle stopped.)	The emergency / parking brake has not be set.	Set the emergency / parking brake.

Condition	Possible cause	Action
Neither video nor audio is output.	The vehicle ignition switch has not been turned on.	Turn the vehicle ignition switch to [ACC] or [ON].
	The connection wires and cables are not completely connected.	Check the connections to each connection wire and cable.
There is a point of light on the display.	At least 99.99% of the pixels on the TFT panel are effective, but it is possible that 0.01% of the pixels may not light or may stay lighted.	This is not a defect, so please use the equipment in this condition.

* Depending on your mobile phone, the mute function may not work correctly. If it does not, press the **M** on the main unit. Refer to the ECLIPSE Web site (<http://www.eclipse-web.com>) for details on applicable phone models.

Glossary

Please read the descriptions for following terms to enjoy more.

- GPS (Global Positioning System)

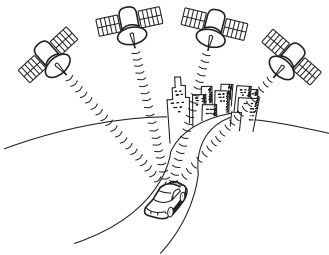

GPS is a system to detect current location (latitude, longitude, altitude) by receiving radiowaves from normally 4 or more, or 3 in some cases, GPS satellites orbiting 21,000 km over the Earth.

These satellites are launched and managed by the US Department of Defense mainly for military use, but are also open for private usage. This unit performs navigation using the GPS information, various sensors, and road map data.

- Wide area map, detailed map

Wide area map is a map with wide area, and detailed map is a map of small area. The scales of a map are 1/20,480,000, 1/10,200,000, 1/5,120,000, 1/2,560,000, 1/1,280,000, 1/640,000, 1/320,000, 1/160,000, 1/80,000, 1/40,000, 1/20,000, 1/10,000, and 1/5,000.

- Measurement



GPS position quality is displayed at left lower. The more bars light, the more extreme precision GPS position quality is.

- 2 dimensional measurement and 3 dimensional measurement

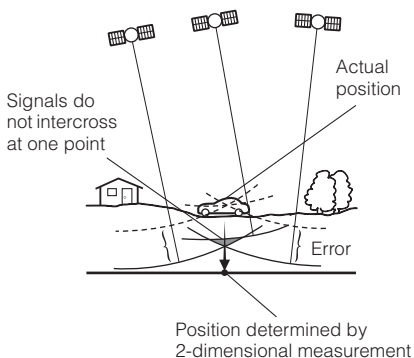

GPS calculates the position using the triangulation.

Distance to the satellite can be determined when the radiowave from that satellite is received, and current location can be measured by receiving radiowave from 3 satellites.

However, since there are margin of error in the GPS satellites and navigation unit, only 2 dimensional measurement of latitude and longitude is performed when radiowave from only 3 satellites are received. The precision will be lower in this case.

The measurement will be taken in 3 dimensions of latitude, longitude, and altitude when radiowave from 4 or more GPS satellites are received. 3 dimensional measurement has higher precision than 2 dimensional measurement, and error of vehicle location becomes smaller.

Specifications

<GPS antenna>

Dimensions	34 (W) × 13.2 (H) × 38 (D) mm
Weight approx.	25 g (Excluding cables and connectors)
Power supply voltage	4.5 +/-0.5(V)
Power consumption	10 to 30 (mA)
Usage temperature	-30 to 80 (°C)
Storage temperature	-40 to 100 (°C)

<Display section>

Liquid crystal panel	7.0" QVGA
Screen dimensions	156.24 (W) × 82.21 (H) mm
Pixel count	391,680 pixels (480 (H) × 272 (V) × 3)
Active pixel rate Over	99.99%
Display format	Transmissive color filter format
Drive system	TFT (thin film transistor) active matrix format
Usage temperature range	-20°C to +60°C
Storage temperature range	-40°C to +70°C

<Radio tuner section>

Reception frequency	AM 530 to 1710kHz (10kHz step)
	FM 87.75 to 107.9MHz (200kHz step)
Practical speed	AM 22μV (S/N20dB)
	FM 12 dBf (IHF)
Frequency characteristic	30 to 15,000 Hz (FM)
Stereo separation	38 dB (1 kHz)

<CD/DVD section>

Wow and flutter	Below measurement limit
Higher harmonic distortion rate	0.01% (0 dB, 1 kHz)
Frequency characteristic	20 to 20,000 Hz
S/N ratio	90 dB (1 kHz)
Dynamic range	88 dB

Specifications

<USB memory section>

USB Interface	1.1/2.0 (support)
Frequency Response	20Hz to 20,000Hz \pm 3dB
S/N Ratio (A-weighted)	75 dB

<Bluetooth>

Compatible Bluetooth	Ver.2.0
Compatible Profile	HFP (Hands Free Profile) Ver.1.5 OPP (Object Push Profile) Ver.1.1 A2DP (Advanced Audio Distribution Profile) Ver. 1.0 AVRCP (Audio/Video Remote Control Profile) Ver.1.0

<Common component>

Rated output	15 W \times 4 (1 kHz, 1% 4 Ω) (EIAJ)
Maximum output	50 W \times 4 (test voltage 14.4 V)
Suitable load impedance	4 Ω (each channel)
Power source voltage	13.2 V DC (11 to 16 V) Grounded
Power consumption	0.5 W \times 4 output time approx. 3.7 A Approx. 15 A max
Exterior dimensions	180 mm (W), 100 mm (H), 166 mm (D)
Weight Approx.	3.2 kg