



Warnings and caution signs, illustrated below, are posted throughout this manual as well as on the AVN5510. They show safe and correct ways to handle the product to prevent personal injury to you and others and avoid damage to property. Before reading through the manual, take time to read through and learn the important information listed in this section.

## **Cautions for use**

\* The illustrations of screens shown in this manual may differ from the actual screens of this product.

	<b>Warning</b>	This WARNING sign indicates a situation in which incorrect handling through disregard of a sign may result in death or serious personal injury.
	<b>Caution</b>	This CAUTION sign indicates a situation in which incorrect handling through disregard of a sign may result in personal injury or may result solely in damage to property.

The symbol shown below indicates that you should know about the information in order to carefully follow it or you should remember the information for its helpfulness.

	This ATTENTION sign indicates helpful information to remember and know.
--	---

- Please read all materials such as manuals and warranties that have come with the product.
- Eclipse will not be responsible for unsatisfactory product performance due to failure to follow these instructions.
- Changes to product specifications may result in differences between content of the manual and features of the product.

	LAMP(S) INSIDE THIS PRODUCT CONTAIN MERCURY AND MUST BE RECYCLED OR DISPOSED OF AS HAZARDOUS WASTE ACCORDING TO LOCAL, STATE, OR FEDERAL LAWS APPLICABLE TO YOU. DO NOT PLACE IN THE TRASH.
---	---

# Table of Contents

---

## Introduction

---

<b>How to use this manual</b> .....	<b>10</b>
<b>Features</b> .....	<b>12</b>
<b>Before using the main unit</b> .....	<b>16</b>
About discs .....	18
About playable discs .....	18
About handling discs .....	19
About new discs .....	19
About rental discs .....	20
About specially shaped discs .....	20
About disc accessories .....	20
About TV .....	21
About the LCD panel .....	21

## Basic operation

---

<b>Switching mode</b> .....	<b>22</b>
Switching the mode .....	22
Switching the mode using panel switches .....	22
Switching the mode using touch switches .....	23
Displaying operation screen .....	23
<b>Operation screen of each mode</b> .....	<b>24</b>
<b>Adjusting the volume</b> .....	<b>26</b>
Adjusting main volume .....	26
<b>Adjusting sound quality</b> .....	<b>27</b>
Setting DSP (acoustics) .....	28
DSP mode setting .....	28
Adjusting, saving DSP (acoustics) .....	28
Resetting DSP (acoustics) levels .....	29
Adjusting EQ (equalizer) .....	30
Adjusting/saving EQ .....	30
Selecting a EQ pattern from memory .....	32
Resetting EQ curves .....	32

Setting POS (position selector) . . . . .	33
Adjusting volume balance . . . . .	34
Setting the BEEP tone . . . . .	35
Muting sound . . . . .	35
Switching the bass enhancement (Tru Bass). . . . .	36
Setting LOUDNESS . . . . .	36
Setting the sub-woofer . . . . .	37
Setting WOOFER OUTPUT . . . . .	38
Selecting phase control . . . . .	38
Selecting the sub-woofer level . . . . .	38
Setting X-OVER . . . . .	39
Setting the harmonizer . . . . .	40
Setting the Circle Surround II . . . . .	41
<b>Setting the background screen . . . . .</b>	<b>42</b>
Setting the wallpaper . . . . .	42
Changing the wallpaper . . . . .	42
<b>Adjusting the background screen . . . . .</b>	<b>43</b>
Setting the opening screen . . . . .	43
Changing the image on the opening screen . . . . .	43
About usable image data . . . . .	43
<b>Adjusting/setting the screen . . . . .</b>	<b>44</b>
Displaying the image adjustment screen . . . . .	44
How to switch to daytime display when the lights are ON . . . . .	45
Turning off the screen . . . . .	45
Adjusting image quality . . . . .	46
Switching screen mode . . . . .	46

## How to operate the tuner

---

<b>How to use the AM / FM radio . . . . .</b>	<b>48</b>
Listening to the AM/FM radio . . . . .	48
Selecting radio stations . . . . .	49
Manual selection . . . . .	49
Automatic selection . . . . .	49
Selection using preset switches . . . . .	49
Selecting radio bands . . . . .	50
Saving radio stations . . . . .	51

Saving manually . . . . .	51
Saving with AUTO.P . . . . .	51
Changing stations saved by AUTO.P . . . . .	51
Turning off the radio . . . . .	53

***How to use HD Radio . . . . . 54***

Listening to HD Radio (IBOC) . . . . .	54
Selecting radio stations . . . . .	55
Manual selection . . . . .	55
Automatic selection . . . . .	55
Selection using preset switches . . . . .	55
Saving radio stations . . . . .	56
Saving manually . . . . .	56
Saving with AUTO.P . . . . .	56
Changing stations saved by AUTO.P . . . . .	56
Displaying information about the current broadcast . . . . .	56
Turning off the radio . . . . .	56

***How to use the SIRIUS satellite radio . . . . . 57***

Listening to SIRIUS satellite radio . . . . .	57
Check the SIRIUS ID . . . . .	57
Changing the SIRIUS band . . . . .	58
Selecting the channel you want to listen to . . . . .	58
Selecting from the available categories . . . . .	58
Selecting a channel by direct input . . . . .	58
Displaying information about the current broadcast . . . . .	59
Turning off the SIRIUS . . . . .	59

## **How to operate the CD player**

---

***How to use the CD player . . . . . 60***

Listening to a CD . . . . .	60
Selecting a song . . . . .	60
Fast-forwarding/rewinding . . . . .	61
Searching for a song . . . . .	61
Repeating a song . . . . .	61
Playing songs in random order . . . . .	62
Turning off the CD player . . . . .	62

# How to operate the MP3/WMA player

---

## ***How to use the MP3/WMA player . . . . . 64***

Playing MP3/WMA . . . . .	65
Selecting a music file . . . . .	65
Selecting with file change switches . . . . .	65
Selecting with TUNE/TRACK button . . . . .	65
Fast-forwarding/rewinding . . . . .	66
Changing display of the current level . . . . .	66
Displaying the current level . . . . .	66
Searching for a music file . . . . .	66
Repeating the same music file . . . . .	67
Playing songs in random order . . . . .	67
About display of file information . . . . .	68
Displaying folder/file names . . . . .	68
Displaying file information . . . . .	68
Turning off the MP3/WMA player . . . . .	68
About MP3/WMA . . . . .	69
Playable MP3 file standards . . . . .	69
Playable WMA file standards . . . . .	70
ID3tag/WMAtag . . . . .	71
Media . . . . .	71
Format of discs . . . . .	72
File names . . . . .	74
Multi-sessions . . . . .	74
Playing MP3/WMA . . . . .	74
MP3/WMA playing time display . . . . .	74
Display order of MP3/WMA file/folder names . . . . .	74
Making and playing MP3/WMA files . . . . .	75
Downloading from Internet MP3/WMA music sites . . . . .	75
Converting CD music to MP3/WMA files . . . . .	75
Writing to CD-R/CD-RW . . . . .	75
When playing back CD-R/RW . . . . .	75

# How to operate the CD changer

---

## ***How to use the CD changer . . . . . 76***

Listening to a CD . . . . .	76
Selecting a song . . . . .	76

Fast-forwarding/rewinding . . . . .	76
Selecting a CD . . . . .	77
Searching for a song or CD from all CDs in changer . . . . .	77
Searching for a song . . . . .	77
Searching for a CD . . . . .	77
Repeating a song or CD . . . . .	78
Repeating the current song . . . . .	78
Repeating the current CD . . . . .	78
Playing songs in random order . . . . .	78
Playing songs on current CD in random order . . . . .	78
Playing songs on all CDs in random order . . . . .	78
Turning off the CD player . . . . .	78

## How to operate iPod®

---

### ***Operating the iPod . . . . . 80***

Listening to iPod . . . . .	80
Selecting a song . . . . .	81
Fast-forwarding/rewinding . . . . .	81
Searching for a song in various ways . . . . .	82
Displaying the search mode screen . . . . .	82
Selecting a song from your favorite GENRE . . . . .	83
Selecting a song from your favorite ARTIST . . . . .	84
Selecting a song from your favorite ALBUM . . . . .	84
Selecting your favorite song from song name list . . . . .	85
Selecting a song from your favorite PLAYLIST . . . . .	85

## How to operate the DVD player

---

### ***Before using the DVD player . . . . . 86***

DVD video characteristics . . . . .	86
About Multiple Languages . . . . .	86
About Multiple Angles . . . . .	86
About Subtitles . . . . .	87
About discs . . . . .	87
About playable discs . . . . .	87
About region codes of playable discs . . . . .	88
About marks displayed on discs . . . . .	88
About DVD disc structure . . . . .	89

About flow of operations . . . . .	90
<b><i>How to use the DVD player . . . . .</i></b>	<b>91</b>
Watching a DVD . . . . .	91
Operating the video . . . . .	92
Playing the video . . . . .	92
Fast-forwarding/rewinding . . . . .	92
Pausing the video . . . . .	93
Stopping the video . . . . .	93
Operating the disc menu . . . . .	94
Turning off the DVD . . . . .	94
Searching for a desired chapter . . . . .	95
Searching by chapter . . . . .	95
Searching by title number . . . . .	95
Searching by menu number . . . . .	96
Changing the touch switch display . . . . .	97
Turning off the touch switches . . . . .	97
Changing the touch switch display locations . . . . .	97
Switching between screen display and audio . . . . .	98
Switching the video angle . . . . .	98
Switching subtitle languages . . . . .	99
Switching dubbed audio language . . . . .	100
Setting the DVD player . . . . .	101
Setting the audio language . . . . .	102
Subtitle language setting . . . . .	103
Menu language setting . . . . .	104
Setting display of multi-angle mark (angle selection mark) . . . . .	105
Viewer restriction setting . . . . .	106
Changing video output . . . . .	107
Table of language codes . . . . .	108

## **How to operate the VTR**

---

<b><i>How to use the VTR . . . . .</i></b>	<b>110</b>
Viewing the VTR . . . . .	110
Switching the VTR setting screen . . . . .	110
Turning off the VTR mode . . . . .	111

## How to operate the TV tuner

---

### ***How to use the TV. . . . . 112***

Watching a TV . . . . .	112
Selecting channels . . . . .	112
Manual selection . . . . .	112
Automatic selection . . . . .	113
Selection using prest switches. . . . .	113
Saving channels. . . . .	114
Saving manually. . . . .	114
Saving with AUTO.P . . . . .	114
Changing stations saved by AUTO.P . . . . .	114
Switching the TV setting screen. . . . .	116
To end TV mode . . . . .	116

## How to use the steering wheel switch

---

### ***About the steering wheel switches. . . . . 118***

Function names and summaries . . . . .	118
Common operations. . . . .	118
Radio operations . . . . .	119
CD player operations . . . . .	119
SIRIUS satellite radio tuner operations . . . . .	119
MP3/WMA Player operations. . . . .	119
DVD operations . . . . .	120
CD changer operations . . . . .	120
TV operations. . . . .	120

## How to use an optional remote control

---

### ***How to use an optional remote control (RMC105). . . . . 122***

Turning the power on/off . . . . .	123
Adjusting the audio volume . . . . .	123
Muting the Volume. . . . .	123
Switching playback modes. . . . .	124
How to play the tuner . . . . .	124
Selecting a station (manually or automatically) . . . . .	124
Selecting preset stations . . . . .	124



How to play CDs .....	125
Switching CD Changer modes .....	125
Advancing to the next track or returning to the beginning of the track being played .....	125
Skipping to the next or previous disc .....	125
Replacing the battery .....	126

## For reference

---

### ***Information you should know* .....** **128**

If one of these messages appears .....	128
Before asking for repairs .....	130

### ***Others* .....** **131**

Products equipped with Dolby Digital .....	131
Products equipped with Macrovision .....	131

### ***Glossary* .....** **132**

### ***Index by topic* .....** **134**

About screen and sound adjustment .....	134
About Using AM/FM radio .....	135
Usage when an HD Radio (IBOC) tuner is connected .....	135
Usage when a SIRIUS satellite radio tuner is connected .....	135
About using the CD player/CD changer .....	135
About using the MP3/WMA player .....	136
About using the iPod .....	136
About using the DVD player .....	137
About using the VTR .....	138
About using the TV tuner .....	138
Useful functions .....	138
When something isn't clear .....	138

### ***INDEX* .....** **140**

The Index by Topic simplifies searches for explanations about individual features. When confused by an operation, use the Index by Topic to search for information about the operation.

# How to use this manual

## Section title

A title is assigned for each section.

## Item title

A number and title is assigned for each item.

## Operation title

A title is assigned for each operation.

## Operation screen

A screen showing the operation will appear.

## Detailed operation title

A title is assigned for each detailed operation.

## Operation procedure

Describes the operation. Proceed with the operation as per the numerical order.

Basic operation

## Adjusting sound quality

### Setting DSP (acoustics)

The DSP function reproduces the sensation of various factory set performance environments by adding reverberation to the music being played.

#### DSP mode setting

- Touching the DSP touch switch brings up the acoustics mode screen as shown.
  - After making settings, touch **BACK**. The acoustics mode adjustments will be saved and the system will return to the previous operation screen.



Touch switch	DSP Environment	Touch switch	DSP Environment
<b>CONCERT</b>	Concert hall	<b>CLUB</b>	Disco, Club
<b>LIVE</b>	Live performance arena	<b>THEATER</b>	Movie theater
<b>CATHEDRAL</b>	Church with echo	<b>OFF</b>	DSP OFF

#### Adjusting, saving DSP (acoustics)

The factory set DSP (acoustics) level for each mode can be adjusted to preference and saved.

- Touch **▲** or **▼** at the right of the screen while in the acoustics mode to be adjusted.
  - There are five + and five - adjustment levels available.



- Touch the switch for the acoustics mode that has been adjusted until a beep is heard.

### ***Resetting DSP (acoustics) levels***

Default settings for the currently adjusted and saved DSP (acoustics) level can be reset.

**1** Touch **OFF** until a beep is heard.

- The acoustic level will be returned to default value (the default value is "0").



When adjusting the level for the currently selected DSP (acoustics) mode, the level will not be saved for other acoustics modes.

Basic  
operation

#### **Section heading**

Only the section heading will appear.

#### **Attention**

Additional points regarding the operations are given here.

#### **Go to the next page**

The operation procedures are continued on the next page.

➔ Go to the next page

**29**

The description shown above is for explanation, and therefore it may differ from the actual one on the same page.

# Features

## DVD player with sharp video and dynamic sound (Page 86)

Plays DVD Video recorded with high quality images and sound.

(DVD media is able to record a movie with high quality video and digital sound that exceeds the quality of CD media.)



## The MP3/WMA player that can play a disc holding many music tracks equivalent to several albums (Page 64)

The MP3 compression technology that can compress the music data by a factor of 10.

The CD-R/RW discs holding MP3/WMA data can be played with this unit. Also, WMA data which provides higher compression rate than MP3 can be played.



## DSP effects for simulating acoustics of various performance environments (Page 28)

Provides ability to simulate the sensation of various performance environments for matching to the genre and source of a song.



## Selection and display of favorite wallpaper (screen backgrounds) (Page 42)

Wallpaper of your choice can be switched and displayed for use as the background of the information screen and audio playback screens.

The screen from a navigation unit can also be linked and selected.



- Setting wallpaper for the information screen and audio operations screen

## Radio tuner for receiving various broadcasts

### • AM/FM tuner (Page 48)

Enables reception of analog AM/FM radio broadcasts.

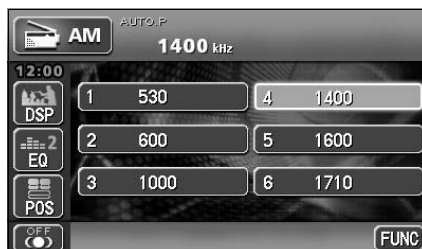

- AM radio operation screen

### • HD Radio (IBOC) tuner (Page 54)

Enables reception of HD Radio (High Definition Radio) broadcasts.

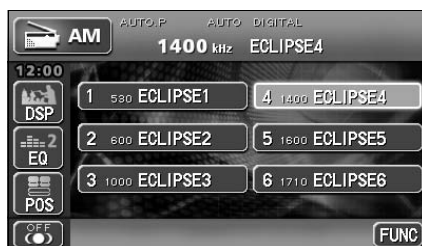

- HD Radio (IBOC) AM operation screen

# Features

## • SIRIUS tuner (Page 57)

SIRIUS is a satellite broadcasting service offering music, news, sports and other programming with CD-quality sound; This is a paid subscription service.

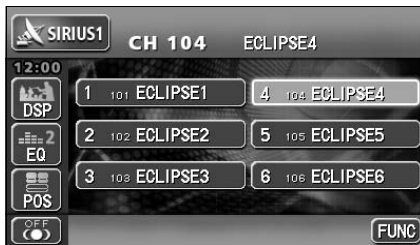

● SIRIUS operation screen

## System additions

### • CD changer (Page 76)

A CD changer enables non-stop playing of multiple discs, for convenience at times such as taking a long drive.

It is easy to search for and play a song from among the discs on a changer.



### • iPod (Page 80)

When an optional iPod interface adaptor (IPC-106) is connected to this main unit, it is possible to operate the iPod® with this main unit and to display information relevant to it on the screen of this main unit, so you can listen to the songs stored in the iPod.

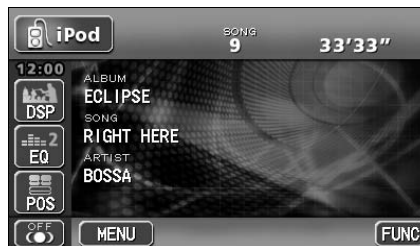

### • TV tuner (Page 112)

Television can be watched if an optional TV tuner is connected.



- **VTR (Page 110)**

Connecting a VTR deck enables watching of video tapes.

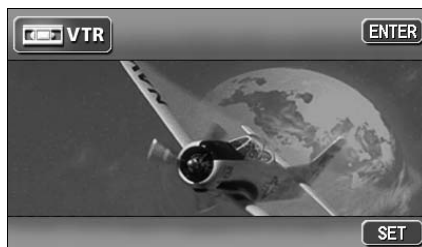

## TEL MUTE

By connecting a handsfree cellular phone adapter with the TEL-MUTE function, the audio is automatically muted when an incoming call is received. Note that the voice guidance is not muted. (For muting on outgoing call, refer to the operation manual of the handsfree cellular phone adapter.)

## Easy-access audio controls on the steering wheel (Page 118)

You can select the radio channel and perform CD, MP3 and DVD operations using the easy-access switches on the steering wheel. (This function is only available on vehicles fitted with steering wheel switches.)

# Before using the main unit

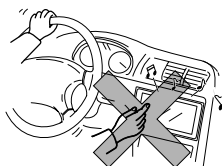

- Be very careful and pay full attention to safety when operating the audio controls while driving, otherwise accidents may occur. Also be sure to set volume so that you can still adequately hear sounds outside the vehicle. Improper use can contribute to a traffic accident.

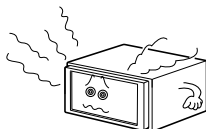

- Never continue to use the system if it is malfunctioning in any way. If smoke, abnormal noises or abnormal odors are noticed, turn off the power immediately. Immediately turn off audio in such situations.

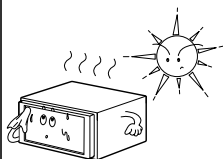

- Exercise caution as to the temperature inside the vehicle. The temperature inside the vehicle can increase during hot weather. Wait for the temperature inside the vehicle to drop before using the unit. Damage could result.

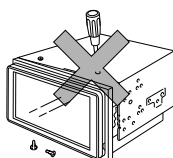

- Do not disassemble or modify the main unit. The main unit has a precisely designed structure, so consult your retailer in the event of any unsatisfactory performance.





Caution

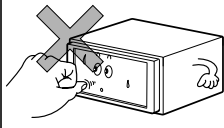

- Do not apply excessive force to the monitor. Damage could result.

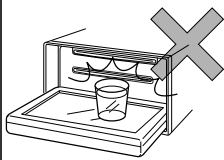

- Do not place items such as cups or cans on top of the monitor, and do not leave the monitor tilted down when not in use. Damage could result.

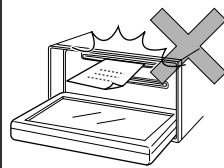

- Do not insert any objects other than discs into the disc slot. Damage could result.

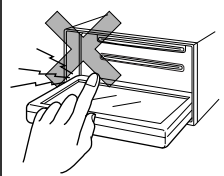

- Be careful not to get fingers or other objects behind monitor when it is being retracted into place. Interference can cause an injury or damage the main unit.

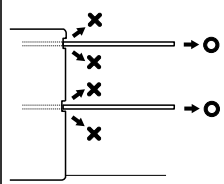

- When removing a disc from the main unit, remove it in the horizontally level direction. Do not pull them up forcibly or press down on them strongly while removing them. Improper removal can scratch the disc, cause the main unit to make noise or result in other damage.

# Before using the main unit

## About discs



- Water droplets can form on the inside of the main unit during cold or rainy weather in the same way car windows can fog up. (This is condensation.) When this happens, the audio can jump and playback can stop, so ventilate or dehumidify the vehicle for a short time before operating the equipment.
- To safeguard the components of the player, the unit will automatically stop when a malfunction occurs. The player will not operate even when messages displayed on the screen are followed, consult with your equipment retailer because it is possible that the unit has been damaged.
- It is possible that the sound will skip if the vehicle experiences violent motion on rough roads.

### About playable discs

- An audio disc or DVD video disc bearing one of the marks below can be played. When using DVD-R/RW (DVD-Recordable/ReWritable) and DVD+R/RW (DVD+Recordable/ReWritable) discs, note that only those whose contents were recorded in the video mode can be played. Discs whose contents were recorded in the video recording (VR) mode cannot be played.



- Discs that are compatible with Dolby Digital and bear the indication below can be used.



Manufactured under license from Dolby Laboratories, Inc. "Dolby" and the double-D symbol are trademarks of Dolby Laboratories.

- It is possible that a CD-R (CD-Recordable) or CD-RW (CD-ReWritable) disc will not play on the main unit due to the circumstances of the recording, special disc characteristics, scratches, dirt or deterioration caused by long storage in the vehicle. In addition, a CD-R or CD-RW disc written with CD-R, CD-RW or UDF format that has not been finalized will not play on the main unit.
- It is possible that a DVD-R/RW (DVD-Recordable/ReWritable) or DVD+R/RW (DVD+Recordable/ReWritable) disc will not play on the main unit due to the circumstances of the recording, special disc characteristics, scratches, dirt or deterioration caused by long storage in the vehicle. DVD-R/RW or DVD+R/RW discs that have not been finalized will not play on the main unit. It may not be possible to play a disc that has been recorded on a personal computer, depending on the application setting and the environment.
- The CD-TEXT function can be used only with the CD-TEXT-compatible compact discs available on the market. If it is used with CD-R or CD-RW discs, characters may not be displayed normally.
- Do not use discs with transparent or semi-transparent portions within the recording area, or C-thru discs, since they may not be accepted and ejected properly and may not play properly.



### About handling discs

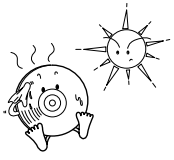

- Be sure to store discs in their cases and keep them out of direct sunlight. Discs can warp and become unusable.

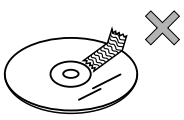

- Do not apply paper-based tape to either the recording side or label side of a disc. Damage could result.

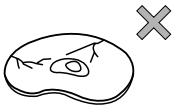

- Do not use discs on which there are cracks or large warps. Damage could result.



- Do not touch the recorded side of a disc when handling it. (This is the side with the rainbow-colored reflection.) The disc may become dirty and that could cause the sound to skip.



- Using a disc that has become dirty can scratch the disc and cause the sound to skip. Use a commercially available compact disc cleaner to clean a CD, wiping lightly from the center to the edge.

### About new discs

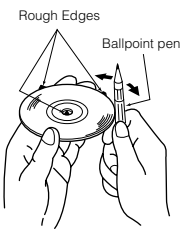

- You may notice that some brand new discs are rough around the center hole or outside edge. Remove the rough edges with the side of a ballpoint pen, etc. Flakes from the rough edges may stick to the recorded surface and interfere with playback.

# Before using the main unit



## About rental discs

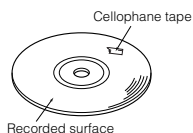

- Do not use CD discs with attached cellophane tape, rental CD discs with glue protruding from labels or discs with the residue of peeled adhesives. Using discs with those conditions can prevent the player from properly opening and closing as well as cause other damage.

## About specially shaped discs

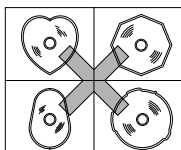

- Specially-shaped or octagonal CDs, like heart-shaped cannot be played. Do not attempt to play them, even with an adapter, since they may damage the player.
- Please do not use a commercially available lens cleaner because it may cause damage to the pickup of the player.

## About disc accessories

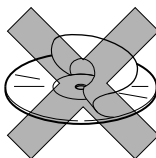

- Do not use accessories (stabilizers, protective seals, laser lens cleaners, etc.) sold for "improving sound performance" or "protecting CDs." The changes in CD thickness or outside dimensions made by these accessories may cause problems in the player.

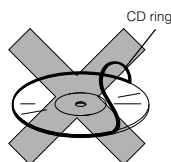

- Please be sure NOT to attach any ring-shape protector (or other accessory) to your discs. Those protectors are commercially available and said to protect discs and to improve sound quality (and antivibration effect), but they can do more harm than good in regular uses. The most common problems are Insert/Eject related problems and "No playback" problems due to the protector ring that may have come off in the disc mechanism.

## About TV



- When connection with the battery is cut due to changing it, changing fuses, etc., all preset channels will be erased.
- It may be difficult for the TV to maintain optimal reception due to variation in signal strength or interference from other objects. The main causes of interference are listed below.
- Visual or audio static may result when in close proximity to overhead train wires, high-tension wires, traffic signals, neon signs, etc.
  - Depending on the signal, buildings and mountains may adversely affect reception.
  - Visual or audio static may result when in close proximity to radio broadcasting or ham radio antennas.
  - Signal reception will become extremely weak when driving through a tunnel.
  - Signal reception will become weak when traveling at a great distance from the broadcasting station.
  - In some areas, visual or audio static may result when in close proximity to TV or radio towers. This is due to the influence of electro-magnetic waves outside of the reception range.

## About the LCD panel



- The LCD panel can appear to be white or black when seen from certain angles.
- The screen will be difficult to read when external light such as sunlight falls on the display.

# Switching mode

The main unit can be used when the vehicle's ignition switch is on or in the ACC position.

- The main unit supports use of a remote control. The optional remote control is sold separately and can be purchased at your local retailer. Refer to page 122 for instructions on operation of the remote control.

## Switching the mode

### Switching the mode using panel switches

1 Press **MENU**.

2 Touch **SOURCE** on the MAIN MENU screen.

- The AUDIO MENU screen will be displayed.

3 Touch **FM**.

- The various audio modes can be selected by touching the corresponding touch switches.
- When the navigation screen is being displayed before pressing **MENU**, the selected mode will be displayed on-screen over the background.

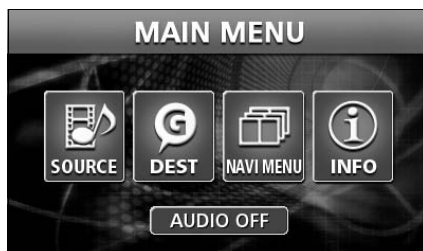

On-screen display

## Switching the mode using touch switches

- 1 Touch the SOURCE MENU switch.

SOURCE MENU switch



- 2 Touch the touch switch of the source you want to operate.

- The operation screen for the selected source is displayed.
- Touching returns to the previous screen.

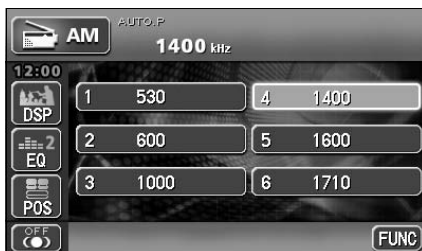

## Displaying operation screen

- 1 Press **AV**.

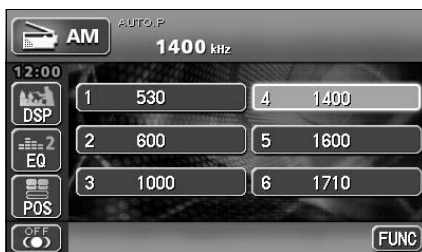

# Operation screen of each mode

The operation screen for each mode will appear as shown below.

- AM radio operation screen

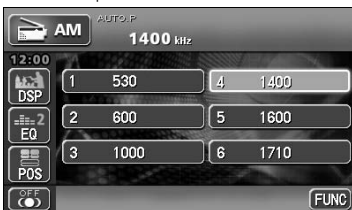

- FM radio operation screen

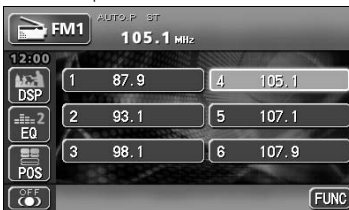

- HD Radio (IBOC) operation screen (optional)

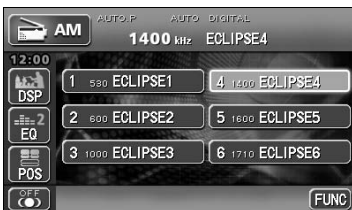

- SIRIUS operation screen (optional)

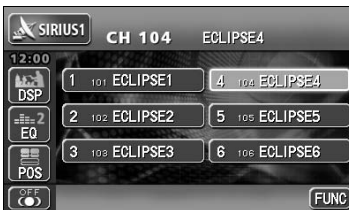

- CD player operation screen

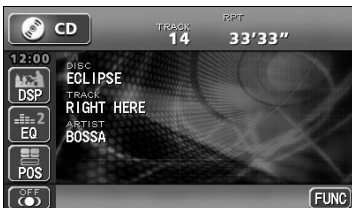

- MP3/WMA player operation screen



- DVD player operation screen



- CD changer operation screen (optional)



- VTR operation screen (optional)

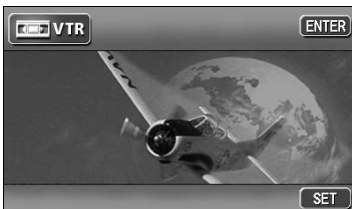

- iPod operation screen (optional)





- TV operation screen (optional)



When the operation screen for DVD or video (VTR/TV) has not been operated for 6 seconds or more, the operation screen will automatically be canceled.

# Adjusting the volume

## Adjusting main volume

### 1 Press the VOLUME switch.

Pressing **+** will increase volume.

Pressing **-** will decrease volume.

- Each press of the switch will change the volume by two steps. When the volume reaches 50 or higher, the switch will change the volume by one step. Holding the switch will continue to change the volume.

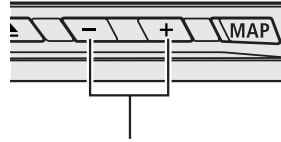

# Adjusting sound quality

To adjust sound quality, touch the DSP, EQ or POS switch while the operation screen for a mode is displayed. Adjustments made in any mode will be saved and applied to all modes.

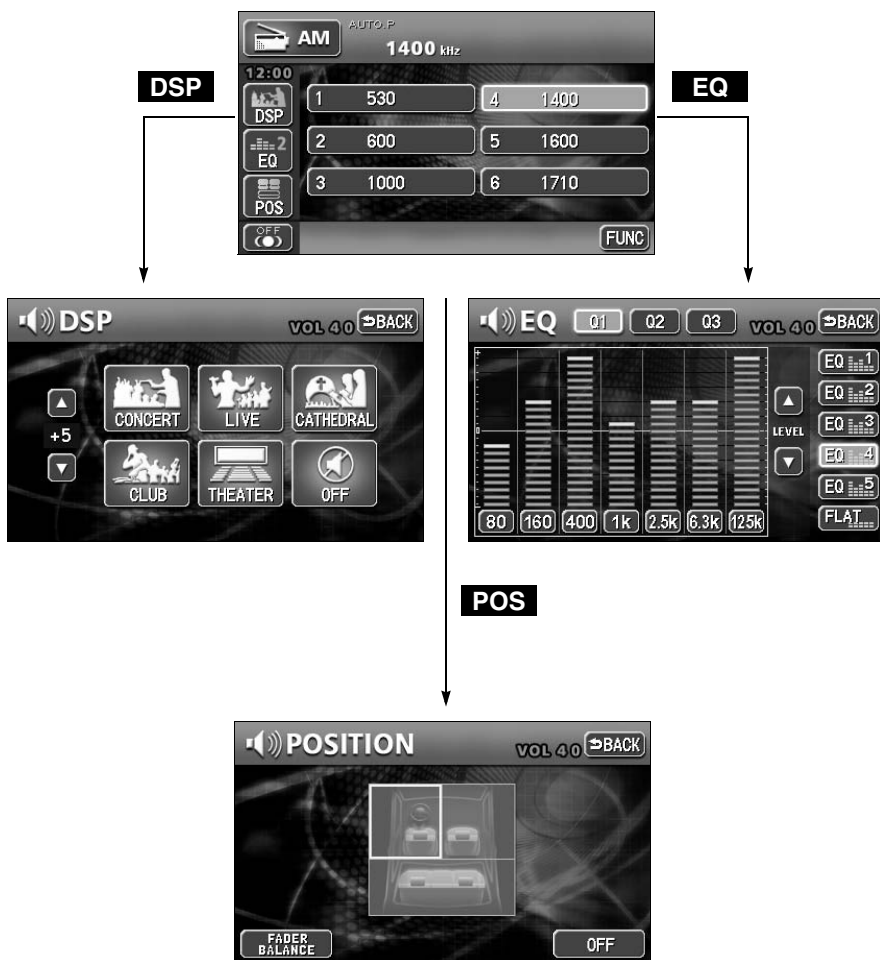

ATTENTION

In the DVD mode, display the sound quality adjustment switches by touching **NEXT** from the operation modes, and then **SET**. In the VTR mode display them either by touching **SET**.

# Adjusting sound quality

## Setting DSP (acoustics)

The DSP function reproduces the sensation of various factory set performance environments by adding reverberation to the music being played.

### DSP mode setting

**1** Touching the DSP touch switch brings up the acoustics mode screen as shown.

- After making settings, touch **BACK**. The acoustics mode adjustments will be saved and the system will return to the previous operation screen.



Touch switch	DSP Environment	Touch switch	DSP Environment
<b>CONCERT</b>	Concert hall	<b>CLUB</b>	Disco, Club
<b>LIVE</b>	Live performance arena	<b>THEATER</b>	Movie theater
<b>CATHEDRAL</b>	Church with echo	<b>OFF</b>	DSP OFF

### Adjusting, saving DSP (acoustics)

The factory set DSP (acoustics) level for each mode can be adjusted to preference and saved.

**1** Touch **▲** or **▼** at the right of the screen while in the acoustics mode to be adjusted.

- There are five + and five - adjustment levels available.

**2** Touch the switch for the acoustics mode that has been adjusted until a beep is heard.



## *Resetting DSP (acoustics) levels*

Default settings for the currently adjusted and saved DSP (acoustics) level can be reset.

**1** Touch **OFF** until a beep is heard.

- The acoustic level will be returned to default value (the default value is "0").



When adjusting the level for the currently selected DSP (acoustics) mode, the level will not be saved for other acoustics modes.

# Adjusting sound quality

## Adjusting EQ (equalizer)

Adjusts sound quality to preferred characteristics according to the music genre and audio source.

### Adjusting/saving EQ

The sound quality can be adjusted according to music genre and then stored. This product has a 7-band parametric equalizer which can adjust median frequency, frequency level, and Q curve (bandwidth).

**1** Touch the frequency of each band to select the frequency (median frequency) you want to adjust.

- Each time the switch of each band is touched, the median frequency will be switched in the order shown below.

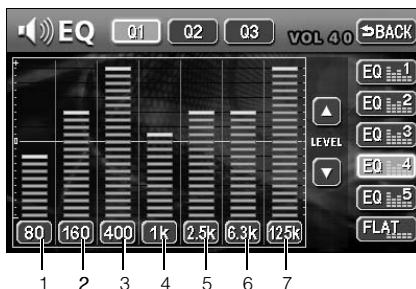

Band	Median frequency (Hz)
1	63 → 80 → 100
2	125 → 160 → 200
3	250 → 315 → 400 → 500
4	630 → 800 → 1k → 1.25k
5	1.6k → 2k → 2.5k → 3.15k
6	4k → 5k → 6.3k → 8k
7	10k → 12.5k → 16k

**2** Touch the desired frequency level.

- To make fine adjustments, touch ▲ or ▼.

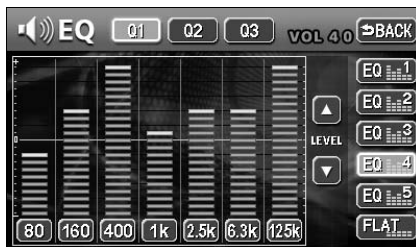

**3** Touch **Q1**, **Q2**, **Q3** to select a Q curve.

- The Q curve patterns set the median frequency bandwidth as follows:

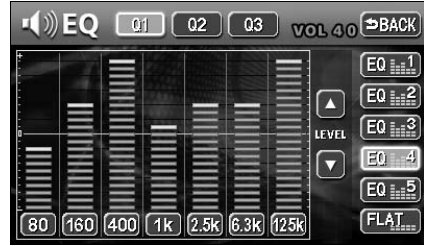

Switch	Q curve pattern
<b>Q1</b>	Wide
<b>Q2</b>	Normal
<b>Q3</b>	Narrow

**4** Repeat steps **1** through **3** to change the setting for each band.

- It is not possible to set more than one band in the same channel to the same median frequency.

**5** Touch the switch you want to use to save (**EQ1** to **EQ5**) until you hear a beep.

- Save the PEQ settings for future use.
- Touch **BACK** after making settings. The PEQ mode adjustment will be saved and the system will return to the previous operation screen.

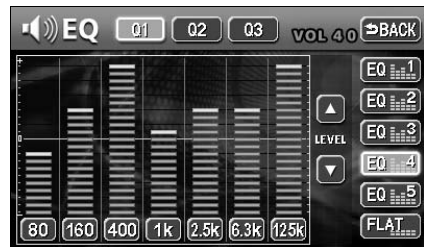

ATTENTION

- If you touch and hold ▲ or ▼ during fine adjustment, the frequency level will continue to adjust automatically until it reaches the center value (0). Touch ▲ or ▼ again to continue adjustment.
- Touch **FLAT** to return to the center value (0).

# Adjusting sound quality

## Selecting a EQ pattern from memory

1 Touch a switch from **EQ1** to **EQ5**.

- The preset pattern stored in memory will be retrieved.
- Touch **BACK** after making settings. The PEQ mode adjustments will be saved and the system will return to the previous operation screen.

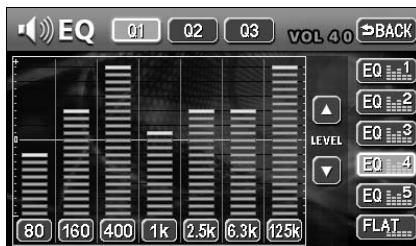

## Resetting EQ curves

The currently saved equalizer can be returned to the default values.

1 Touch **FLAT** until you hear a beep.

- The equalizer curve will be reset to the default values.

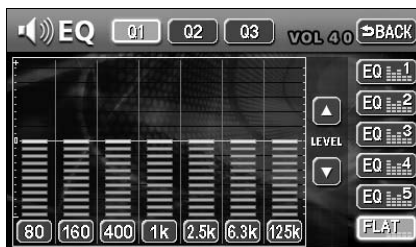



## Setting POS (position selector)





The stereophonic position for obtaining optimum acoustic effects can be adjusted to match the number and position of passengers.

In addition, front-to-back, right-to-left volume balance can be adjusted for the selected position.

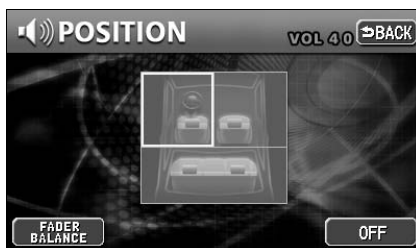
**1** Touching the image of a seat shown on the POS setting screen will change the position.

- The selected position will change its color to orange. Touching the seat again will cancel the selection. The four positions shown by the table below can be set.
- Touching **OFF** will cancel all settings.
- After making settings, touch **BACK**. The position will be saved and the system will return to the previous operation screen.



Touch switch	Function	Touch switch	Function
	Acoustics optimized for driver's seat		Acoustics optimized for both front seats
	Acoustics optimized for passenger's seat		Acoustics optimized for rear seats



- This setting cannot be done at the same time as adjustment of the volume balance (see next page) and the Circle Surround II (page 41).
- The main unit is configured for vehicles with a left-side driver's position.

# Adjusting sound quality



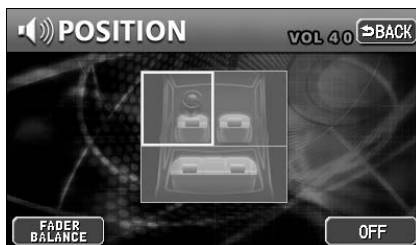

## Adjusting volume balance

The set position for front-to-back, right-to-left volume balance can be adjusted.







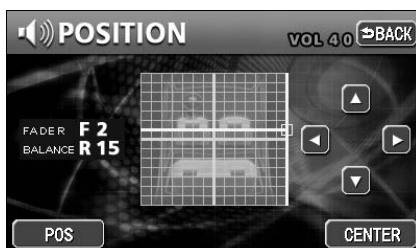
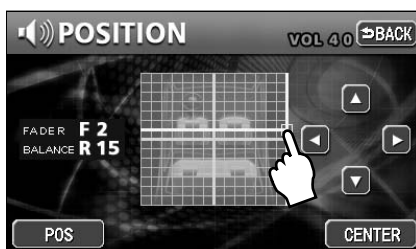

- 1 Touch **FADER BALANCE** on the **POSITION** setting screen to display the volume balance adjustment screen.



- 2 Touch the screen at the preferred balance point.

- To make fine adjustments, touch , , , or .
- Touching **CENTER** will set the volume balance to the center position.
- After making settings, touch **BACK**. The set volume balance will be saved and the system will return to the previous operation screen.
- To set the POS again, touch **POS**.



- This setting cannot be done at the same time as POS (position selector) adjustment, described on the previous page.
- Touching and holding , , , or  while making fine adjustments will adjust values in a continuous action. However, adjustment will lock when it reaches the center value, and , , , or  must be pressed again to continue adjustment.

## Setting the BEEP tone

The guide tone that is emitted when touching a panel switch or touch switch can be set.

- 1 Press **MENU**.
- 2 Touch **INFO** on the MAIN MENU screen.
- 3 Touch **SETTING** on the INFORMATION screen.
- 4 Touch **1**, **2**, **3**, **4** or **OFF** of GUIDE TONE.
  - The pressed touch switch will become brighter.
  - Touching **OFF** will cancel (turn off) the guide tone.
- 5 Touch **ENTER**.

## Muting sound

Sound from the audio system can be temporarily muted.

- 1 Press **MUTE**.
  - Volume will become zero.
  - Pressing **MUTE** switch again will return to previous volume.
  - The VOLUME display will flash during mute.

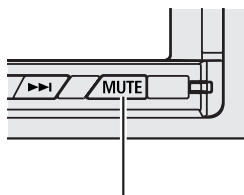

MUTE switch



The MUTE function will be canceled on pressing the **+** VOLUME switch (it is unaffected by pressing the **-** switch).

# Adjusting sound quality

## Switching the bass enhancement (Tru Bass)

You can switch the bass enhancement.

- Note that the Tru Bass is adjusted only when the Circle Surround II (page 41) effectiveness is set to Low or Hi.

- 1 Press **MENU**.
- 2 Touch **INFO** on the MAIN MENU screen.
- 3 Touch **SETTING** on the INFORMATION screen.
- 4 Touch **NEXT**.
- 5 Touch **ON** or **OFF** of Tru Bass.
- 6 Touch **ENTER**.



## Setting LOUDNESS

Audio can be modulated to correct for insufficient low and high sounds when listening at low volume.

- 1 Press **MENU**.
- 2 Touch **INFO** on the MAIN MENU screen.
- 3 Touch **SETTING** on the INFORMATION screen.
- 4 Touch **NEXT**.
- 5 Touch **ON** or **OFF** of LOUDNESS.
  - The pressed touch switch will become brighter.
- 6 Touch **ENTER**.



## Setting the sub-woofer

When a sub-woofer is connected, the preferred output level for the audio can be set.

- 1 Press **MENU**.
- 2 Touch **INFO** on the MAIN MENU screen.
- 3 Touch **SETTING** on the INFORMATION screen.
- 4 Touch **NEXT**.
- 5 Touch **WOOFER** in the setting screen.



# Adjusting sound quality

## Setting WOOFER OUTPUT

The sub-woofer output can be set to STEREO or MONO. Select the method that matches the output method for the connected sub-woofer system.

- 1 Touch **STEREO** or **MONO** for WOOFER OUTPUT.
  - Touch **BACK** after making settings. The woofer output setting will be saved and the system will return to the previous screen.



## Selecting phase control

The merging of sound between the front and rear speakers and the sub-woofer can be improved by selecting the phase.

Switch to a phase which lets the speakers combine without any disharmony.

- 1 Touch **NORMAL** or **REVERSE** for PHASE CONTROL.
  - Touch **BACK** after making settings. The phase control will be saved and the system will return to the previous screen.



## Selecting the sub-woofer level

The output level of the sub-woofer can be adjusted with this function.

- 1 Touch **▲** or **▼** for WOOFER LEVEL.
  - ▲: Increase level
  - ▼: Decrease level
  - Touch **BACK** after making settings. The woofer level will be saved and the system will return to the previous screen.



## Setting X-OVER

The frequencies for the front and rear speaker high-pass filter (HPF) and sub-woofer low-pass filter (LPF) can be set within a range of 63 / 80 / 100 / 125 / 160 / 200 Hz. (This is the same as setting the HPF and LPF cutoff frequencies.)

**1** Touch **◀** or **▶** to select the cut off frequency.

**2** Touch **6dB/oct**, **12dB/oct** or **PASS** to select the slope.

- Touch **BACK** after making settings. The crossover setting will be saved and the system will return to the previous screen.



If no sub-woofer has been connected, set the slope adjustment to "PASS". (If slope is set to a setting other than PASS, the low frequency range will not be output from the speakers.)

# Adjusting sound quality

## Setting the harmonizer

It is possible to set the sound quality boost level to automatically regenerate harmonics such as reverberation, depth, and tone lost in compression, producing a much clearer sound.

- 1 Press **MENU**.
- 2 Touch **INFO** on the MAIN MENU screen.
- 3 Touch **SETTING** on the INFORMATION screen.
- 4 Touch **NEXT**.
- 5 Touch **LOW**, **HI** or **OFF** for HARMONIZER.

- **LOW**: Low level of correction
- **HI**: High level of correction
- **OFF**: No correction

- 6 Touch **ENTER**.

- Selection can be made when MP3/WMA disc is inserted into the unit.





## Setting the Circle Surround II

The Circle Surround II reproduces deep bass and localization of sound without a center speaker and/or a sub-woofer.

This is also applied to the audio of radio and TV. However, it is not effective for the AM radio.

**1** Touch **OFF**, **LOW** or **HI** on the operation screen.

- Touch **SET** (in TV and VTR mode) or touch **NEXT** and then **SET** (in DVD mode) to display the touch switches for adjusting sound quality.
- Each time touch switch is touched, the screen display will be changed in the order shown below.



- **LOW**: The effectiveness to reproduce the deep bass sound and the localization of sound is low.
- **HI**: The effectiveness to reproduce the deep bass sound and the localization of sound is high.
- **OFF**: Cancels the function.



The Circle Surround II setting cannot be done at the same time as DSP (Page 28), POS (the position selector) adjustment (Page 33) and LOUDNESS adjustment (Page 36).

# Setting the background screen

The background for the audio screen, information screen and navigation screen can be changed to a preferred wallpaper.

## Setting the wallpaper

### Changing the wallpaper

- 1 Press **MENU**.
- 2 Touch **INFO** on the MAIN MENU screen.

- 3 Touch **SETTING** on the INFORMATION screen.

- 4 Touch **1**, **2**, **3**, **4** or **5** of WALL PAPER.

- The pressed touch switch will become brighter and the wallpaper (background) will change.

- 5 Touch **ENTER**.

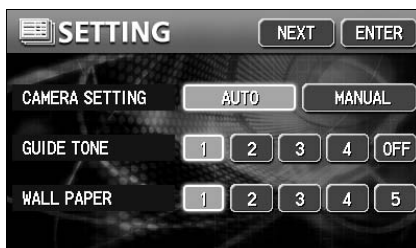

# Adjusting the background screen

## Setting the opening screen

The image displayed on the opening screen (which is displayed when the power is turned on) can be changed to your favorite one stored in a CD-R/RW.

### Changing the image on the opening screen

- 1 Insert a CD-R/RW disc that includes your favorite image.
  - It would take approximately 30 seconds to read the image data. While the image data is being read, do not operate the main unit and the ignition key.
- 2 Touch **Opening Image Change**.
- 3 Touch the image you want to display on the opening screen.
- 4 Touch **OK**.
  - Be sure to eject the CD-R/RW disc that includes the image data.

### About usable image data

The format of disc and image data that can be used on the opening screen are shown in the table below. If your disc and/or data does not meet the conditions below, the file names may not be listed nor displayed correctly.

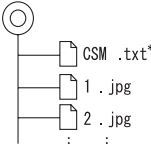
	CD-R/RW
Disc format	ISO9660 (MODE1)
File size	Smaller than 100 KB
File name	ISO9660 LEVEL 2 (Up to 31 bytes)
File extension	.jpg (Non-JPEG2000-compliant)
Writing method	Single-session only
Image size	416 (W) X 240 (H) dots (Max.)
Displayed file	The files in the root directory (top-most directory) only. 

\*When storing the image data in a CD-R/RW disc, make a text file named "CSM.txt" (any content/text is OK) and store it together with the image data.

- If the image size is larger than the condition above, the image cannot be previewed or imported.
- If the image size is smaller than the condition above, the image will be displayed at the center of screen.
- Only one image data can be imported at a time.

# Adjusting/setting the screen

Quality adjustments can be made for the images such as the audio operation screen, navigation screen and DVD or VTR (optional).

## Displaying the image adjustment screen

Contrast, brightness and other picture settings can be adjusted to match preferences for viewing DVD video or the audio operation screen.

To make viewing easier, the display switches between day screen/night screen according to whether the vehicle lights (parking lights, taillights, license plate lights) are on/off.

(Default settings)

- When vehicle lights are on: [Night screen is displayed]
- When vehicle lights are off: [Day screen is displayed]

[Audio operation screen]

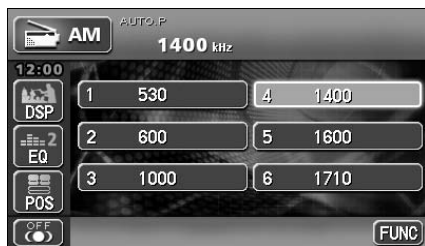

- Day display [Vehicle lights are off]

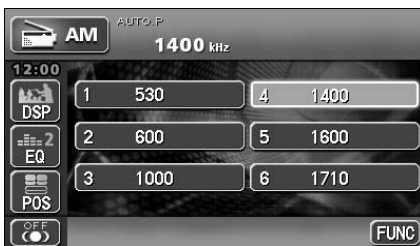

- Night display [Vehicle lights are on]

[DVD/VTR Screen]



- Day display [Vehicle lights are off]



- Night display [Vehicle lights are on]

1 Press and hold **MENU** until a beep is heard on the audio mode screen or DVD/VTR/TV screen.

2 Touch **ENTER** after making any adjustments.

- If no adjustments are made after 20 or more seconds, the image quality adjustment screen will be canceled.

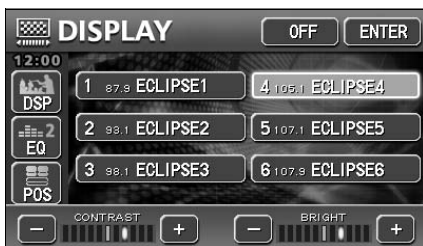

- When adjusting audio operation screen



- When adjusting DVD/VTR/TV screen

### How to switch to daytime display when the lights are ON

1 The day screen and night screen will be switched each time **DAY** is pressed.



- When adjusting audio operation screen



- When adjusting DVD/VTR/TV screen

### Turning off the screen

1 Touch **OFF**.

- Press **AV** or **MAP** to return to the original screen.

# Adjusting/setting the screen

## Adjusting image quality

The day screen and night screen can be separately adjusted (on the audio operation screen, the navigation screen, and the DVD/VTR/TV screen).



- When adjusting audio operation screen or navigation screen



- When adjusting DVD/VTR/TV screen

### ■ CONTRAST

1 Touch **+** to strengthen contrast, **-** to weaken contrast.

### ■ BRIGHT

1 Touch **+** to make lighter, **-** to make darker.

### ■ COLOR (for DVD/VTR/TV screen only)

1 Touch **+** to strengthen green color, **-** to strengthen red color.

### ■ TINT (for DVD/VTR/TV screen only)

1 Touch **+** to make tint darker, **-** to make tint lighter.

## Switching screen mode

1 Touch **WIDE** on DVD, VTR or TV operation screen.

2 Touch **NORMAL**, **WIDE1**, **WIDE2** or **WIDE3**.

- This selects the wide mode.



### 3 Touch **BACK**.

- Returns to the DVD, VTR or TV operation screen.



#### ■ NORMAL mode

The screen is shown with vertical to horizontal ratio of 3 to 4 (normal TV screen size) and side edges are black.



#### ■ WIDE 1 mode

The screen for vertical to horizontal ratio of 3 to 4 (normal TV screen size) is uniformly expanded in the left and right directions.

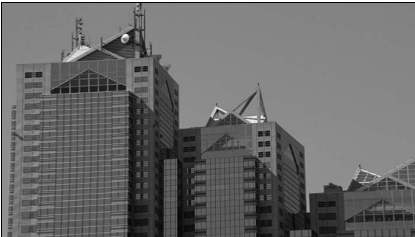

#### ■ WIDE 2 mode

The screen for vertical to horizontal ratio of 3 to 4 (normal TV screen size) is uniformly expanded in the left and right directions (except for the central section of the screen).



#### ■ WIDE 3 mode

The screen for vertical to horizontal ratio of 3 to 4 (normal TV screen size) is uniformly expanded in the upward, downward, left and right directions.



Caution

Viewing of wide screen modes is permitted when limited to the personal entertainment of the user, but caution is required when using technologies such as image compression and expansion for the purpose of commercial benefit or public presentation may infringe upon the rights of the copyright holder being protected by applicable copyright law.

# How to use the AM / FM radio

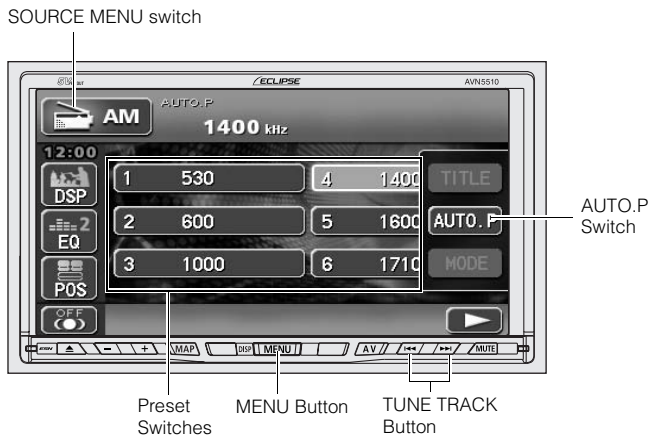

## Listening to the AM/FM radio

- 1 Press **MENU**.
- 2 Touch **SOURCE**.
- 3 Touch **AM** to receive AM radio, or **FM** to receive FM radio.



When an HD Radio (IBOC) tuner is connected, the standard radio (analog radio) is also controlled through the HD Radio tuner. Note that this means the antenna should be connected to the HD Radio tuner.



## Selecting radio stations

### Manual selection



1 Press  or .

- Each pressing of the switch moves the frequency one step up or down. (One step on the AM band is 10kHz. One step on the FM band is 0.2MHz.)

 : Raises frequency

 : Lowers frequency

### Automatic selection

1 Press and hold  or  until a beep is heard.

- The station that is closest in frequency to the frequency that is currently displayed on the screen will be searched for automatically, and searching will stop when the station is received. To stop the search before a station is found, press the button again.

### Selection using preset switches

1 Touch the preset switch that already has a station recorded.

- Refer to "Saving radio stations" on page 56 for details on saving stations.



If the reception for a particular station is weak in the area you are in, automatic selection may not work.

# How to use the AM / FM radio

## Selecting radio bands

1 Touch **FUNC**.

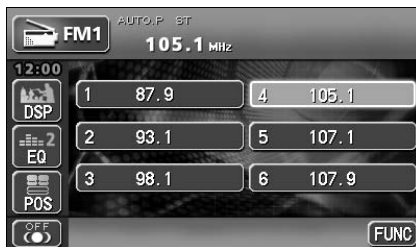

2 Touch **BAND**.

- Each time the switch is touched, the radio band will be changed in the order shown below.

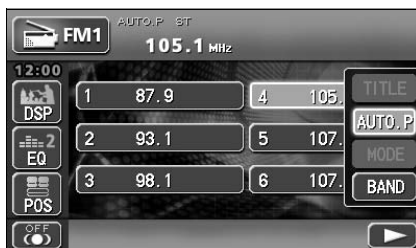

## Saving radio stations

There are two modes for saving radio stations, manual and AUTO.P, and these modes operate independently.

### *Saving manually*

Confirm that "AUTO.P" is not displayed in the upper part of the screen.

- If "AUTO.P" is displayed, touching **AUTO.P** will switch the screen to manual.

**1** Use manual tuning or automatic tuning to select the station to be saved.

**2** Choose a preset switch and touch it until a beep is heard.

- The radio station (frequency) is set. Touching the preset switch will now tune in the selected station.

### *Saving with AUTO.P*

**1** Touch **FUNC**.

**2** Touch **AUTO.P** until a beep is heard.

- The AUTO.P function will be activated and start automatically selecting stations. A beep will be heard when automatic selection of stations is completed. On touching **AUTO.P** again, the display will switch to the previously recorded station.

### *Changing stations saved by AUTO.P*

**1** Use manual tuning or automatic tuning to select the station to be saved.

**2** Choose a preset switch and touch it until a beep is heard.

# How to use the AM / FM radio

## About AUTO.P

Because AUTO.P temporarily saves stations for the preset switches, stations saved manually will remain in memory even if AUTO.P is used. By manually saving stations that are used regularly, these manually saved stations can be restored even after AUTO.P has been used, such as after traveling.

Touching **AUTO.P** while AUTO.P is being used or after AUTO.P has been used will return the preset memories back to the condition they had before AUTO.P was used. (Doing so will delete the stations saved with AUTO.P.) The flow for switching from AUTO.P to manual is shown below.

If the BAND is switched to another BAND, the saved station with AUTO.P is cleared.

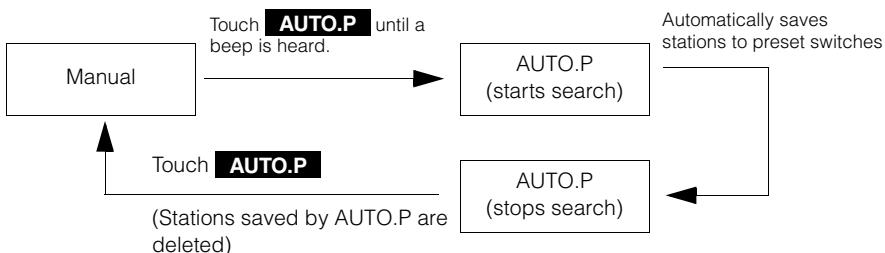

- AUTO.P may not automatically receive stations if radio waves in the surrounding area are weak.
- A station saved by the tuning switch may not match a station saved by AUTO.P even though the signal is received from the same station.
- Due to conditions for receiving radio waves, saved stations may differ even when the AUTO.P switch is operated repeatedly in the same location.
- Up to six stations having good reception sensitivity are automatically saved in order starting from the lowest frequency.
- When less than six stations capable of reception are found, nothing is saved for the remaining preset switches.
- In the FM mode, when the BAND is switched to another BAND, the AUTO.P is canceled temporarily.

## Turning off the radio

1 Press **MENU**.

2 Touch **AUDIO OFF**.

- Touching **AUDIO OFF** again on the MAIN MENU screen will turn on the radio and resume reception of the radio station (frequency) received before power was turned off.



# How to use HD Radio

When an optional HD Radio (High Definition Radio) tuner is connected, HD Radio (High Definition Radio) broadcasts can be received.

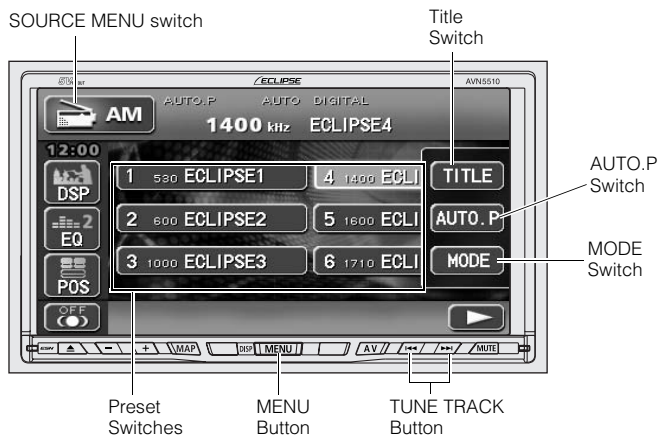

## Listening to HD Radio (IBOC)

When receiving HD Radio (High Definition Radio) broadcasts, FM reception has the same quality as a CD, and AM reception has the same quality as conventional FM sound.

Depending on the reception status, HD Radio can also receive analog broadcasts, which means reception is still possible in regions with no digital coverage.

**1** Press **MENU**.

**2** Touch **SOURCE**.

**3** Touch **AM** to receive AM radio, or **FM** to receive FM radio.

- When an HD Radio (IBOC) tuner is connected and a digital broadcasting program is received, "DIGITAL" is displayed.
- When an HD Radio (IBOC) tuner is connected, the **TITLE** touch switch becomes available.



With the **MODE** switch, you can switch between analog and digital broadcasting.

## Selecting radio stations

### Manual selection

1 Press  or .

- Each pressing of the switch moves the frequency one step up or down. (One step on the AM band is 10kHz. One step on the FM band is 0.2MHz.)

 : Raises frequency

 : Lowers frequency

### Automatic selection

1 Press and hold  or  until a beep is heard.

- The station that is closest in frequency to the frequency that is currently displayed on the screen will be searched for automatically, and searching will stop when the station is received. To stop the search before a station is found, press the button again.

### Selection using preset switches

1 Touch the preset switch that already has a station recorded.

- Refer to "Saving radio stations" on page 56 for details on saving stations.



If the reception for a particular station is weak in the area you are in, automatic selection may not work.

# How to use HD Radio

## Saving radio stations

There are two modes for saving radio stations, manual and AUTO.P, and these modes operate independently.

### Saving manually

Refer to "How to use the AM / FM radio" on page 51.

### Saving with AUTO.P

Refer to "How to use the AM / FM radio" on page 51.

### Changing stations saved by AUTO.P

Refer to "How to use the AM / FM radio" on page 51.

## Displaying information about the current broadcast

When receiving an HD Radio (IBOC) broadcast, information about the current broadcast, such as the name of the radio station, the album, the title of the track, the artist, and the musical genre, can be displayed.

1 Touch **FUNC**.

2 Touch **TITLE**.

- Touch **TITLE OFF** to return to the operation screen.



## Turning off the radio

1 Press **MENU**.

2 Touch **AUDIO OFF**.

- Touching **AUDIO OFF** again on the MAIN MENU screen will turn on the radio and resume reception of the radio station (frequency) received before power was turned off.

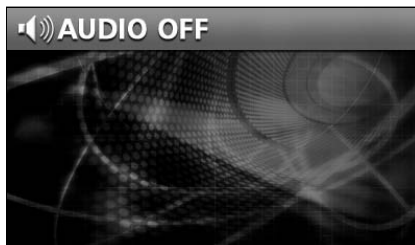



# How to use the SIRIUS satellite radio

When an optional SIRIUS satellite radio tuner is connected, SIRIUS satellite radio broadcasts can be received.

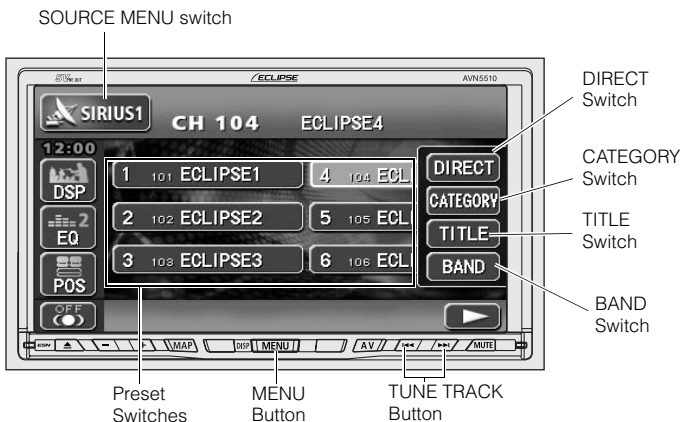

## Listening to SIRIUS satellite radio

With SIRIUS satellite radio, over 100 channels are available including music, news, and entertainment programs.

You can select the channel you want from 27 categories such as POP and ROCK, or you can select a channel by direct input.

Reception of SIRIUS satellite radio is a paid subscription.

- 1 Press **MENU**.
- 2 Touch **SOURCE**.
- 3 Touch **SIRIUS**.

## Check the SIRIUS ID

The SIRIUS ID number is a 12-digit numerical code that is assigned each time the SIRIUS satellite radio tuner is connected.

- 1 Touch **SIRIUS ID** on the INFORMATION screen.
  - A 12-digit numerical code is displayed.

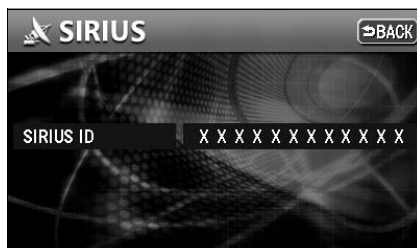

# How to use the SIRIUS satellite radio

## Changing the SIRIUS band

1 Touch **FUNC**.

2 Touch **BAND**.

- The BAND changes.

[SIRIUS 1] → [SIRIUS 2] → [SIRIUS 3] → [SIRIUS 4] ... → return to [SIRIUS 1]

## Selecting the channel you want to listen to

### Selecting from the available categories

1 Touch **FUNC**.

2 Touch **CATEGORY**.

3 Select the category that you want.

- Touch ▲ or ▼ to switch categories.

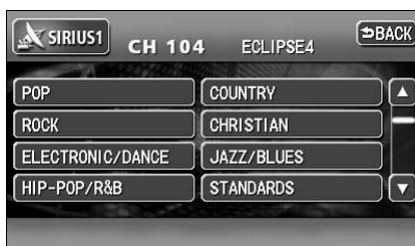

If the selected category is unobtainable, the blank category button appears.

### Selecting a channel by direct input

1 Touch **FUNC**.

2 Touch **DIRECT**.

3 Input a channel.

4 Touch **ENTER**.

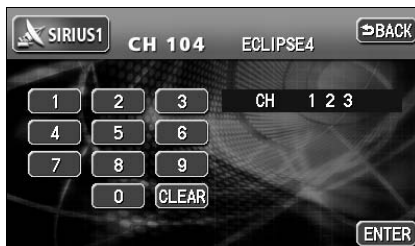

## Displaying information about the current broadcast

During SIRIUS broadcasts, information including the channel name, the album name, the title, and the artist can be displayed for the current track.

1 Touch **FUNC**.

2 Touch **TITLE**.

- Touch **TITLE OFF** to return to the operation screen.



## Turning off the SIRIUS

1 Press **MENU**.

2 Touch **AUDIO OFF**.

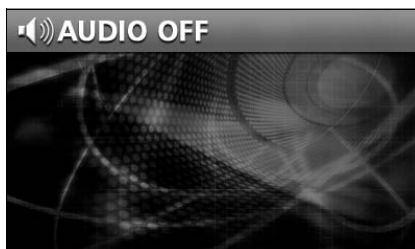

# How to use the CD player

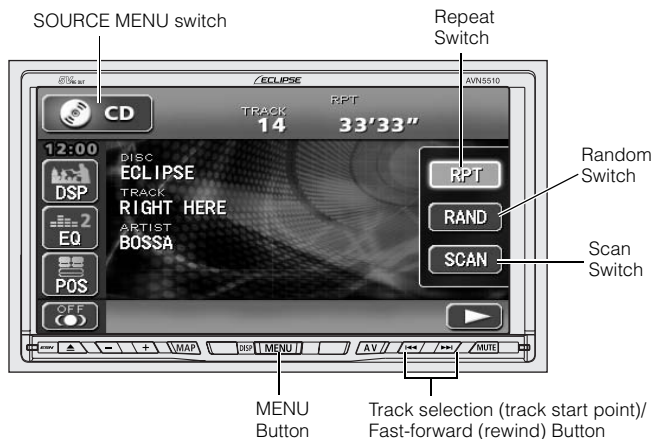

## Listening to a CD

When a CD is inserted into the disc slot, it automatically starts playing.

**1** Press **MENU** while a CD is inserted.

**2** Touch **SOURCE**.

**3** Touch **CD**.

- Playback will begin.

## Selecting a song

You can select a song you want to hear.

**1** Press **▶▶** or **◀◀**.



- **▶▶** : Selects next song
- **◀◀** : Selects previous song
- **▶▶** (down button): Restarts current track. Pressing the down button once more continuously plays previous tracks.



- Titles and song names can be displayed when they are recorded on a CD. Up to 32 characters can be shown in the display.
- Only characters recorded by ASCII code can be shown on the CD-TEXT display.
- The CD-TEXT display may not be able to show characters for discs recorded with many title characters.

## Fast-forwarding/rewinding

It is possible to fast-forward/rewind the song played currently.

**1** Press and hold  or  until a beep is heard.

-  : Fast-forwards

-  : Rewinds

The main unit switches to the fast-forward (rewind) mode when the beep is heard and will continue fast-forwarding (rewinding) until your finger is removed from the switch.

## Searching for a song

**1** Touch **FUNC**.

**2** Touch **SCAN**.

- The main unit will play the first 10 seconds of each song. Touching **SCAN** again will continue playing the current song.

## Repeating a song

**1** Touch **FUNC**.

**2** Touch **RPT**.

- Touching **RPT** once will cause repeating of the song until the function is canceled. Touching **RPT** again will cancel repeating of the song.

# How to use the CD player

---

## Playing songs in random order

1 Touch **FUNC**.

2 Touch **RAND**.

- Touching **RAND** will play songs in random order until the function is canceled. Touching **RAND** again will cancel random playing of songs.
- The song to be played next is randomly selected at the end of current song, so it is possible that a single song could end up being played twice in a row.

## Turning off the CD player

1 Press **MENU**.

2 Touch **AUDIO OFF**.

- Touching **AUDIO OFF** again on the MAIN MENU screen will start resume playback.

# MEMO

CD



# How to use the MP3/WMA player

For safety considerations, some functions are disabled while the vehicle is in motion.

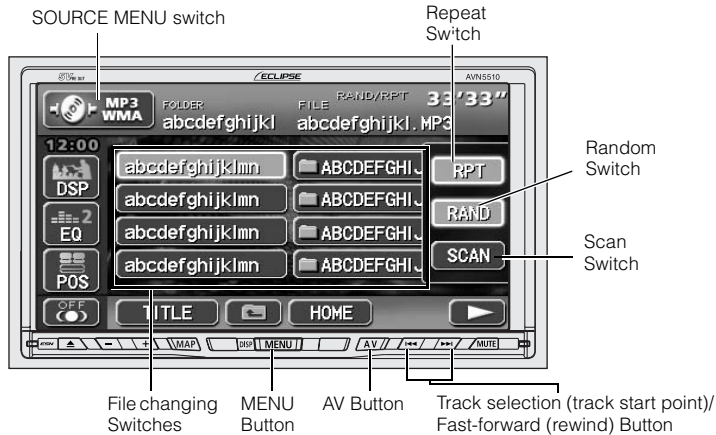

The following operating procedures are based on this example of MP3/WMA file structure below.

## Example of MP3/WMA file structure

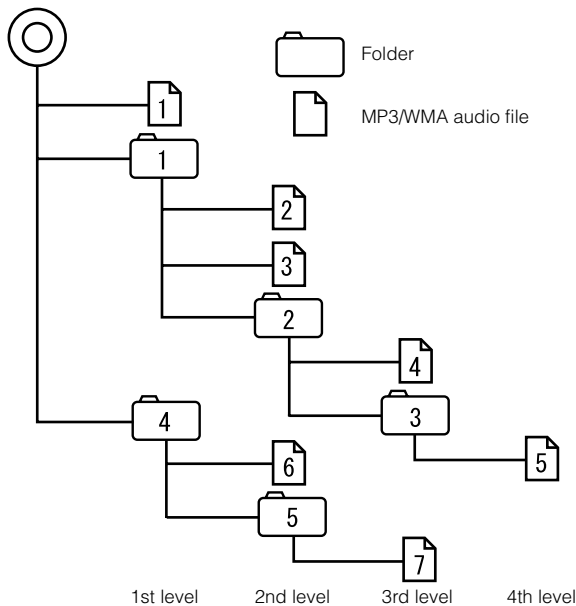









## Playing MP3/WMA

When a CD is inserted into the disc slot, it automatically starts playing.

**1** Press **MENU** while a disc is inserted.

**2** Touch **SOURCE**.

**3** Touch **MP3 WMA**.



- Playback will begin.
- The CD player screen will be shown for about 2 seconds as the system checks whether the inserted CD is a music CD or MP3/WMA disc.
- Normally, tracks are played back in the order  →  →  →  →  →  → .
- When multiple MP3/WMA files and folders are on the same level, they are played in ascending order by folder and file names.

## Selecting a music file

A music file located within a folder can be selected.

### Selecting with file change switches



**1** Touch the music file.

- The currently selected file name and folder name will be shown in the display.
- When more than 8 music files are located in the same folder, touching  or  can switch between the data. (This function is not available when the vehicle is in motion.)

### Selecting with TUNE/TRACK button

When several music files are located in the same folder, the next music file or previous music file can be selected with the track selection (track start point).

**1** Press  or .

-  : Selects next music file
-  : Selects previous music file  
Restarts current track. Pressing the down button once more continuously plays previous tracks.





If sound data and MP3/WMA data are mixed on the same disc, only the data recorded in the first session can be played.

# How to use the MP3/WMA player

## Fast-forwarding/rewinding

It is possible to fast-forward/rewind in the song being played.

**1** Press and hold  or  until a beep is heard.

-  : Fast-forwards
-  : Rewinds

The main unit switches to the fast-forward (rewind) mode when the beep is heard and will continue fast-forwarding (rewinding) until your finger is removed from the switch.

## Changing display of the current level

The folder level can be switched and displayed.

**1** Touch .

-  : Displays the next higher folder level.

## Displaying the current level

Displays the file currently being played.

**1** Touch **HOME**.

- **HOME** : Displays the level of the file currently being played.

## Searching for a music file

**1** Touch **FUNC**.

**2** Touch **SCAN**.

- The system will play the first 10 seconds of each song located within the same layer of the folder currently being played. Touching **SCAN** again will continue playing the current song.



Refer to page 64 for an example of MP3/WMA file structure.

When the display shows the folder and files of the second level (2, 3 and 2) as 4 of the third level is being played, touching **HOME** will show the folder and files of the third level (4 and 3).

## Repeating the same music file

1 Touch **FUNC**.

2 Touch **RPT**.

- The file currently being played will be repeated.
- Setting RPT will cause repeating of the song until the function is canceled. Touching **RPT** again will cancel repeating of the song.

## Playing songs in random order

1 Touch **FUNC**.

2 Touch **RAND**.

- Files will be randomly selected from among all files at the same level as the folder currently being played.
- **RAND** will play songs in random order until the function is canceled. Pressing **RAND** again will cancel random playing of songs.
- Touching **RPT** while the random function is operating will repeat the currently playing song. Touching **RPT** again will return to random playing of songs.
- The song to be played next is randomly selected at the end of current song, so it is possible that a single song could end up being played twice in a row.

# How to use the MP3/WMA player

## About display of file information

Folder names and file information (album name and song titles) recorded on the disc can be displayed.

### Displaying folder/file names

- 1 Press **AV** to display the operation screen.



### Displaying file information

- 1 Touch **TITLE**.
  - The **TITLE** switch will change to **TITLE OFF** while file information is being displayed. Touching **TITLE OFF** will change the display to a folder/file switch.



## Turning off the MP3/WMA player

- 1 Press **MENU**.
- 2 Touch **AUDIO OFF**.
  - Touching **AUDIO OFF** again on the MAIN MENU screen will start resume playback.

## About MP3/WMA

MP3 (MPEG-1 Audio Layer III) is a standard format for audio compression technology. By using MP3, a file can be compressed to one-tenth the size of the original.

WMA (Windows Media™ Audio) is the audio compression format by Microsoft. This can compress files to a smaller size than MP3 can.

This unit has limitations on MP3/WMA file standards and recorded media and formats that can be used. Be aware of the following points when recording MP3/WMA files.

### *Playable MP3 file standards*

- Supported standards : MPEG-1 Audio Layer III
- Supported sampling frequencies : 16, 22.05, 24, 32, 44.1, 48 (kHz)
- Supported bit rate : 8 to 320 (kbps)
  - \* Supports VBR.
  - \* Does not support free format.
  - \* Bit rates vary for MPEG-1 and MPEG-2.
- Supported channel modes : stereo, monaural, dual channel, joint stereo

# How to use the MP3/WMA player

## Playable WMA file standards

- Supported standard : WMA Ver. 7, 8, 9
- Supported sampling frequencies : 44.1, 48 (kHz)
- Supported bitrates : 48 to 192 (kbps)
  - \* VBR is supported (48 to 192 kbps)
  - \* No support for reversible compression (loss-less compression)

Playable sampling frequencies and supported bitrates

		Sampling frequencies (Hz)	
		48 k	44.1k
		2 (ch)	2 (ch)
Bitrates (bps)	192 k	○	○
	160 k	○	○
	128 k	○	○
	96 k	×	○
	80 k	-	○
	64 k	×	○
	48 k	×	○
	VBR	○	○
	192 k max	192 k max	

○ : Playable

× : Not playable

- : No combination

## ***ID3tag/WMAtag***

MP3 and WMA files have an "ID3tag/WMAtag" that allows input of text information so that data such as song title and artist can be saved.

This unit supports ID3v.1.0 and ID3v.1.1 tags. Use only ASCII code to record tags, since only ASCII code is supported by this equipment. Recording of characters not included in ASCII code will result in display of garbled characters.

This unit supports the WMA tag (v1.20.02). Since the WMA tag supports unicode only, please input the information with unicode characters.

## ***Media***

Media capable of playing MP3/WMA includes CD-ROM, CD-R and CD-RW discs.

Compared to CD-ROM media commonly used for music discs, CD-R and CD-RW discs are fragile in high temperature/high humidity environments and one section of the CD-R/CD-RW may become incapable of playback. Fingerprints or scratches on the disc may prevent playback or cause skipping during playback.

Sections of CD-R/CD-RW may deteriorate if left inside a vehicle for long periods of time.

It is also recommended that CD-R/CD-RW discs be kept in a light-blocking case because the discs are vulnerable to ultra-violet light.

# How to use the MP3/WMA player

## Format of discs

The format of discs to be used must be as following:

- Disc format : CD-ROM (MODE 1), CD-ROM XA (MODE2 Form1)
- File format : ISO9660 Level 1 or Level 2  
ROMEO system, JOLIET system

MP3/WMA files recorded in a format other than the one explained above may result in files that cannot be played normally and in file names and folder names that do not display properly.

Limitations in addition to standards are as follows.

- Maximum directory layers : 8 layers
- Maximum characters for folder names/file names : 30 characters for MP3 (including delimiter "." + file extension 3 characters)  
15 characters for WMA (including delimiter "." + file extension 3 characters)
- Allowable characters for folder names/file names : A to Z, 0 to 9, \_ (underscore)
- Number of files possible on a single disc : 384
- Number of folders possible on a single disc : 127



## Configuration example for CD supporting MP3/WMA

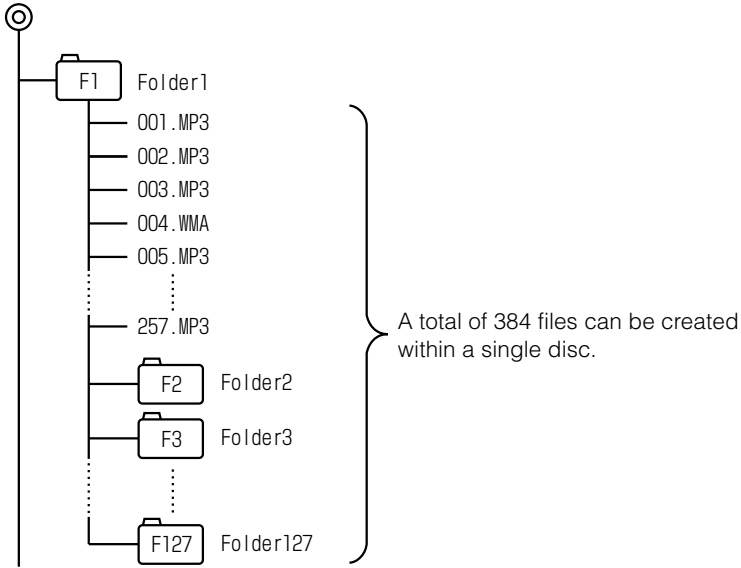

- A total of 127 folders can be recorded on a single disc.

# ***How to use the MP3/WMA player***

## ***File names***

Only files with the MP3/WMA file extension ".mp3/.wma" can be recognized as MP3/WMA and played. Be sure to save MP3/WMA files with the ".mp3/.wma" file extension.

Use half-width English capital letters to write "MP3" or "WMA" of the extension.

## ***Multi-sessions***

Multisessions are supported and CD-R/RW with recorded MP3/WMA files can be played. When written with "Track at once", however, finalize the disc with session close or write protect.

## ***Playing MP3/WMA***

When a disc having MP3/WMA files recorded on it is inserted into the main unit, the system first checks all the files on the disc. If the number of files and folders is large, the check will take some time.

While the system is checking the disc, the music that had been playing continues to play.

In order to speed up completion of the file check, it is recommended that you avoid recording files that are not MP3/WMA files and avoid establishing unnecessary folders.

In addition, it is recommended that you record all data in a single session because a multisession disc takes time for CD control information acquisition.

## ***MP3/WMA playing time display***

It is possible that playing time will not be correct, depending on the writing condition of the MP3/WMA file.

\* It is possible that playing time will not be correct when VBR Fast Up/Down is operated.

## ***Display order of MP3/WMA file/folder names***

Names of MP3/WMA folders and files within the same level are displayed in the following order.

1. MP3/WMA files displayed first, by ascending order of numbers, letters.
2. Folders displayed next, by ascending order of numbers, letters.



If the ".mp3/.wma" file extension is attached to a file other than an MP3/WMA file, that file will be mistakenly recognized by the main unit as an MP3/WMA file and played, resulting in loud noise output that can damage the speakers. Be sure to avoid attaching the ".mp3/.wma" file extension to files that are not MP3/WMA files.

## Making and playing MP3/WMA files

MP3/WMA files created by recording broadcasts, records, audio recordings, video recordings or live performances cannot be used for purposes other than personal entertainment without permission of the copyright holder as set forth in copyright law.

### Downloading from Internet MP3/WMA music sites

There are many kinds of sites that distribute MP3/WMA files on the Internet, such as "pay per download" online shopping sites, "try before you buy" listening sites and free download sites. Follow the rules for each site (such as paying fees) and download according to site instructions.

### Converting CD music to MP3/WMA files

Prepare a computer with commercially available MP3/WMA encoding software (conversion software). (Some encoding programs available on the Internet do not require payment.) Music data files in MP3/WMA format can be made by inserting the music CD into the CD-ROM drive of the computer and following the procedures of the MP3/WMA encoding software to compress the songs of the music CD. A 12cm music CD (having a maximum of 74 minutes of recording/650MB of data) can be compressed to 65MB (about 1/10 of the original size).

### Writing to CD-R/CD-RW

MP3/WMA files can be recorded on CD-R/RW by using a CD-R/RW drive connected to a computer. Record by setting the recording format of the recording software to ISO9660 level 1 or level 2 (not including extension format).

Select CD-ROM ( mode1 ) or CD-ROM XA ( mode2 ) for the disk format.

### When playing back CD-R/RW

Insert a CD-R/RW disc having recorded MP3/WMA files. The system will automatically determine whether the disc is a music CD or a CD-R/RW with MP3/WMA files and begin playing the disc. A music CD recorded onto a CD-R/RW can also be played. However, depending on the type of disc being used, a disc may not play.



- A fixed bit rate of 128kbps and sampling frequency of 44.1kHz is recommended for obtaining stable audio quality at playback.
- Depending on the characteristics of a disc, CD-R and CD-RW may not be able to read the disc.
- Because there are many types of MP3/WMA encoding software available, including commercial and freeware programs, audio quality may deteriorate, noise may be generated when playing starts and some recordings may not play, depending on the condition of the encoder and the file format.
- When files other than MP3/WMA files are recorded on a disc, the system may take some time to recognize the disc and it may not play the disc.

# How to use the CD changer

An optional CD changer can be connected and used.

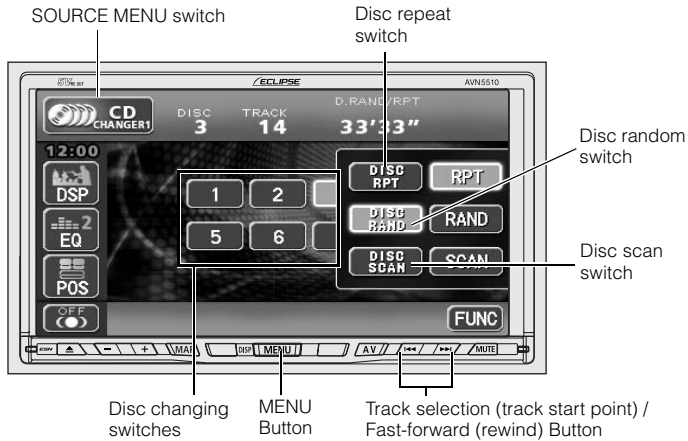

## Listening to a CD

- 1 Press **MENU**.
- 2 Touch **SOURCE**.
- 3 When only one CD changer is connected, touch **CDCHANGER1**. When two CD changers are connected, touch **CDCHANGER1** or **CDCHANGER2**.

## Selecting a song

Refer to "How to use the CD player" (Page 60).

## Fast-forwarding/rewinding

Refer to "How to use the CD player" (Page 61).

## Selecting a CD

A CD can be selected from among all the discs on a changer.

**1** Touch one of the disc changing switches.

- The number for the selected CD will change color.

## Searching for a song or CD from all CDs in changer

### Searching for a song

Refer to "How to use the CD player" (Page 61).

### Searching for a CD

**1** Touch **FUNC**.

**2** Touch **DISC SCAN**.

- The system will play the first 10 seconds of the first song on each CD in the changer. Touching **DISC SCAN** again will continue playing the current song.



- The system will display the amount of disc changing switches that matches the number of CDs that can be inserted into the CD changer, and it will only allow selection of disc numbers that have discs currently loaded.
- No operation is possible when there are no discs loaded into the CD changer.
- If two CD changers are connected, switch between the optional CD changers and the CD changer with **CDCHANGER1** / **CDCHANGER2**.

# How to use the CD changer

## Repeating a song or CD

### *Repeating the current song*

Refer to "How to use the CD player" (Page 61).

### *Repeating the current CD*

**1** Touch **FUNC**.

**2** Touch **DISC RPT**.

- Touching **DISC RPT** once will cause repeating of the CD until the function is canceled. Touching **DISC RPT** again will cancel repeating of the CD.

## Playing songs in random order

### *Playing songs on current CD in random order*

Refer to "How to use the CD player" (Page 62).

### *Playing songs on all CDs in random order*

**1** Touch **FUNC**.

**2** Touch **DISC RAND**.

- Touching **DISC RAND** will play songs in random order until the function is canceled. Touching **DISC RAND** again will cancel random playing of songs.
- The song to be played next is randomly selected at the end of current song, so it is possible that a single song could end up being played twice in a row.

## Turning off the CD player

**1** Press **MENU**.

**2** Touch **AUDIO OFF**.

- Touching **AUDIO OFF** again on the MAIN MENU screen will start resume playback.

# MEMO



# Operating the iPod

When an optional iPod interface adaptor (iPC-106) is connected, it is possible to operate the iPod® with this main unit.

- iPod is for legal or rightholder-authorized copying only. Don't steal music.
- iPod is a trademark of Apple Computer, Inc., registered in the U.S. and other countries.



ATTENTION

- For the functions of the iPod, refer to the iPod User's Guide.
- For the specific details of the iPod operation and connection, refer to the Instruction Manual of the optional iPod interface adaptor (iPC-106).
- It is assumed here that the iPod has already connected to this main unit with an optional iPod interface adaptor (iPC-106).

## Listening to iPod

- 1 Press **MENU**.
- 2 Touch **SOURCE**.
- 3 Touch **iPod**.
  - Playback will begin





---

## Selecting a song

You can select a song you want to hear.

**1** Press  or .



-  : Selects next song
-  : Selects previous song  
Restarts current track. Pressing the down button once more continuously plays previous tracks.

---

## Fast-forwarding/rewinding

It is possible to fast-forward/rewind the song played currently.

**1** Press and hold  or  until a beep is heard.

-  : Fast-forwards
-  : Rewinds

The main unit switches to the fast-forward (rewind) mode when the beep is heard and will continue fast-forwarding (rewinding) until your finger is removed from the switch.

# Operating the iPod

## Searching for a song in various ways

You can select a song you want to listen to from ALBUM, ARTIST, PLAYLIST, GENRE or SONG.

### Displaying the search mode screen

**1** Touch **MENU** repeatedly until the search mode screen (top menu) as shown below is displayed.

**2** Touch **PLAYLIST**, **ARTIST**, **ALBUM**, **GENRE** or **SONG** and select the song you want to listen to.

- If no operation was performed on the search mode screen for 10 seconds, it returns to the playback.

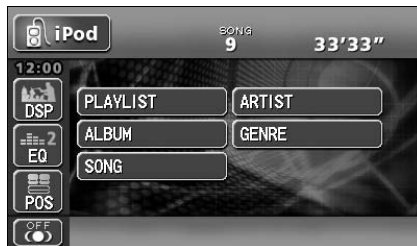

Search mode screen (top menu)



ATTENTION

### About text display

Alphanumeric and symbols can be used for text display. Even if the characters other than alphanumeric and symbols are displayed on your iPod, they are not displayed on this unit.

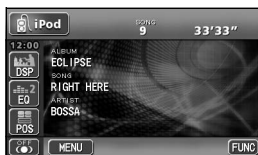

Playback mode screen

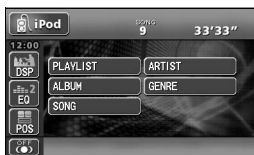

Search mode screen

## Selecting a song from your favorite **GENRE**

- 1 Touch **GENRE** on the search mode screen.
  - All the genre names stored in the iPod that is connected to this unit will be displayed.

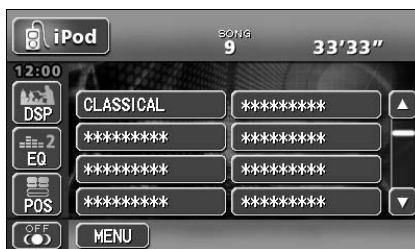

- 2 Touch **GENRE** name you want to browse.
  - The **ARTIST** names stored in the selected **GENRE** will be displayed.
- 3 Touch **ARTIST** name you want to browse.
  - Touching **ARTIST** briefly will display the **ALBUM** names stored in the selected **ARTIST**.
  - By touching **ARTIST** for several seconds, the first track in the selected **ARTIST** will start playing.
- 4 Touch **ALBUM** name you want to browse.
  - Touching **ALBUM** briefly will display the song names stored in the selected **ALBUM**.
  - By touching **ALBUM** for several seconds, the first track in the selected **ALBUM** will start playing.
- 5 Touch the song name you want to listen to.
  - The selected song will be played.

# Operating the iPod

## Selecting a song from your favorite ARTIST

**1** Touch **ARTIST** on the search mode screen.

- All the stored ARTIST names will be displayed.

**2** Touch ARTIST name you want to browse.

- Touching it briefly will display the ALBUM names stored in the selected ARTIST.
- By touching **ARTIST** for several seconds, the first track in the selected ARTIST will start playing.

**3** Touch ALBUM name you want to browse.

- Touching it briefly will display the song names stored in the selected ALBUM.
- By touching **ALBUM** for several seconds, the first track in the selected ALBUM will start playing.

**4** Touch the song name you want to listen to.

- The selected song will be played.

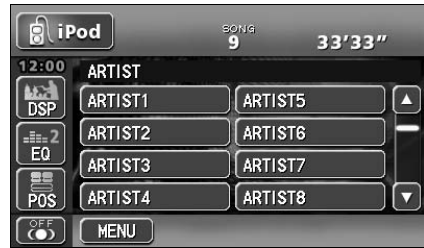

## Selecting a song from your favorite ALBUM

**1** Touch **ALBUM** on the search mode screen.

- Touching it briefly will display all the stored ALBUM names.

**2** Touch ALBUM name you want to browse.

- Touching it briefly will display the song names stored in the selected ALBUM.
- By touching **ALBUM** for several seconds, the first track in the selected ALBUM will start playing.

**3** Touch the song name you want to listen to.

- The selected song will be played.

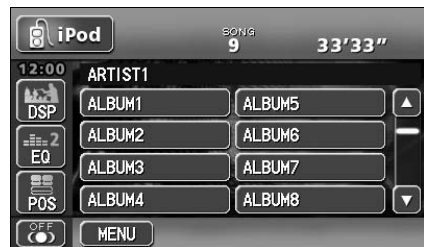

## Selecting your favorite song from song name list

1 Touch **SONG** on the search mode screen.

- Touching it briefly will display all the stored song names.

2 Touch the song name you want to listen to.

- The selected song will be played.

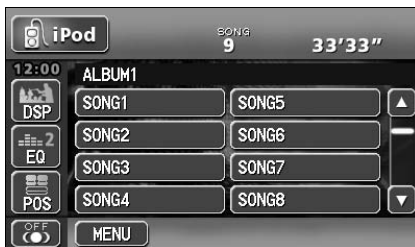

## Selecting a song from your favorite PLAYLIST

1 Touch **PLAYLIST** on the search mode screen.

- Touching it briefly will display all the stored PLAYLIST names.
- Touching it for several seconds will play all the songs for every PLAYLIST.

2 Touch the PLAYLIST name you want to listen to.

- The selected PLAYLIST will be played.
- Touching **ALL SONGS** will play all the songs for every ALBUM.

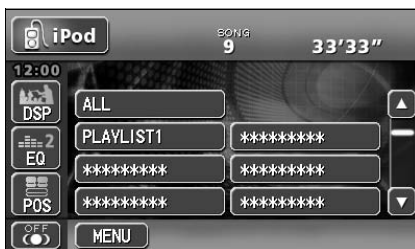

About REPEAT/RANDOM function

- REPEAT, RANDOM and ALBUM RANDOM correspond to the "Song REPEAT", "Shuffle" and "ALBUM shuffle" functions of the iPod, respectively.
- Touching **FUNC** will display the **RPT**, **RAND** and **ALBUM RAND** button.

# Before using the DVD player

This equipment can play high quality images and high quality digital sound of DVD videos. It is also possible to switch between different languages recorded on the DVD video (dubbing, subtitles, etc.), and with videos having several angles of the same scene recorded, the preferred angle can be selected and played.

## DVD video characteristics

### About Multiple Languages

Some DVD discs have dialog recorded in several different languages, and the language can be switched during playback in the same way as multilingual TV broadcasts.



An airplane was flying  
in the night sky...

### About Multiple Angles

Some DVD discs have a single scene recorded from several different angles (multiple angle), and the preferred angle can be switched during playback.

\* Depending on the disc, multiple angles may not be viewed.

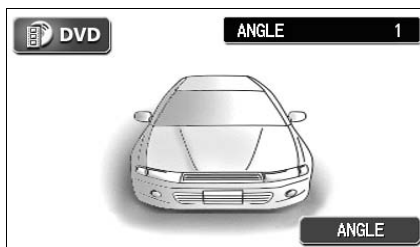
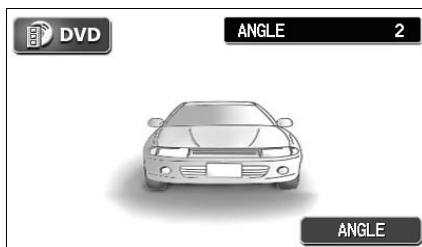

The angle of the image is changed.



Caution

This equipment includes copyright protection technology used in accordance with US patents and other intellectual property rights owned by Macrovision Corporation and other entities. Use of this copyright protection technology requires approval from Macrovision Corporation and the technology must not be used for audiovisual purposes aside from general household use without special approval from Macrovision Corporation. Modification and disassembly of this technology is prohibited.

## About Subtitles



Some DVD discs have subtitles recorded in several different languages, and the subtitles can be switched during playback. The video can also be played without any subtitles displayed.



## About discs

### About playable discs

This equipment conforms to NTSC color television methods, so please use discs that display "NTSC" on the disc or package. This equipment cannot play discs using color television methods other than NTSC (such as PAL, SECAM).

Playable Disc Types and Their marks	Size/Playing Surface	Maximum Playing Time
	12 cm/single-sided 1 layer 2 layer	Using MPEG 2 133 min. 242 min.
	12 cm/double-sided 1 layer 2 layer	266 min. 484 min.

# Before using the DVD player

## About region codes of playable discs







Some DVD discs display a  ("Region Code"). The mark (a number) shows the geographical region where the disc can be played. This equipment will not play discs that do not show "1" or "ALL" in this mark. Even if the disc does play, the message "Cannot play this disc" will be displayed on the screen. Note also that some discs may be subject to regional restrictions, meaning that this equipment will not play them, even though they list or state a region code.

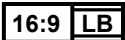

The playing condition is determined by the intention of the DVD/software creator. Some functions may not perform during operation because this equipment is playing the disc according to content specifications intended by the software creator. Be sure to consult the explanatory material provided with the disc to be played.

## About marks displayed on discs

The following mark may be displayed on a DVD disc or its package.

mark	Meaning
	Shows number of voice tracks.
	Shows number of subtitle languages.
	Shows number of filmed angles.
 	Shows available aspect ratio (television screen horizontal to vertical ratio). • "16:9" is wide screen, "4:3" is standard screen.
 	Shows playable region code. • ALL indicates worldwide. A number indicates a specific region code. "1" is the region number for North America.



## About DVD disc structure

Videos and songs recorded on a DVD are divided into many segments.

Large segments are called "titles", and each title has a number ("title number"). Title segments are further divided into smaller segments called "chapters", and each chapter has a number ("chapter number").

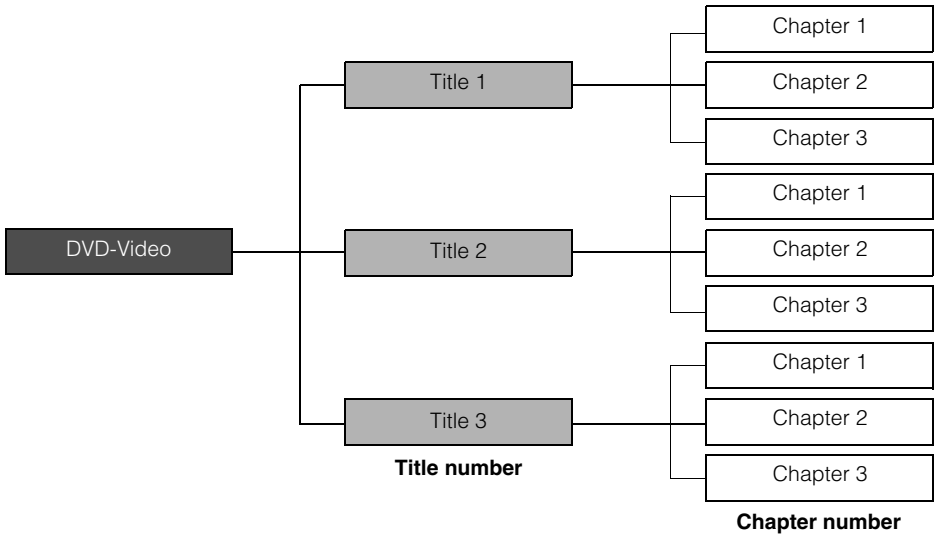

# Before using the DVD player

## About flow of operations

The section below describes the flow for items such as operation and search of images and default settings for the DVD player.

- Touching a touch switch brings up the operation screen shown below.

● DVD operation screen



● Title screen

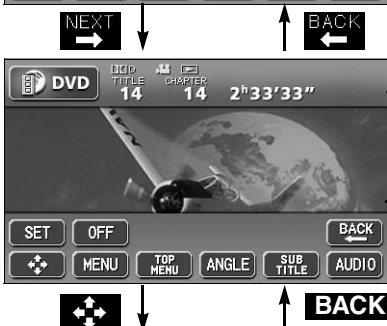
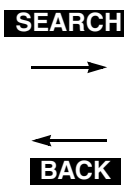

● Menu operation screen



● Menu number search screen



● Default settings screen

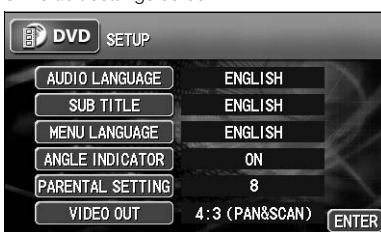

# How to use the DVD player

A DVD can be watched only if the vehicle is completely stopped in a safe location with the parking brake set and the ignition switch turned to ON or ACC. (Only sound can be heard if a DVD is played while the car is in motion.)

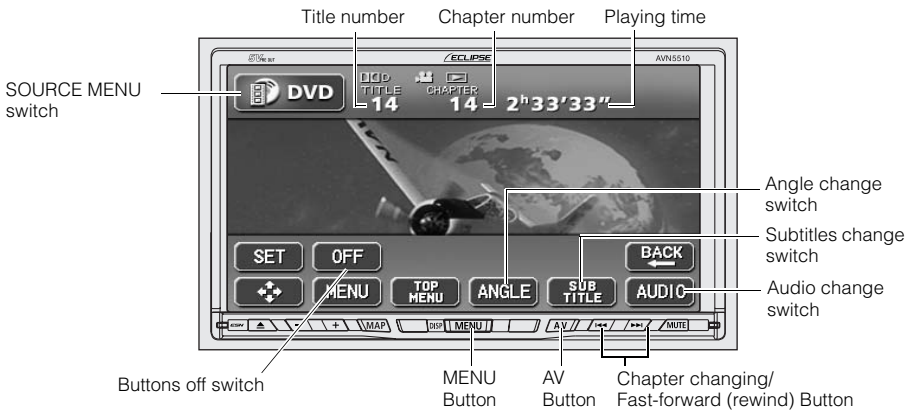

## Watching a DVD

Start playback by inserting a DVD into the DVD insertion slot, which will automatically turn on power.

**1** Press **MENU** while a disc is inserted.

**2** Touch **SOURCE**.

**3** Touch **DVD**.

- Playback will begin.
- If the operation switches (touch switches) are not being displayed, press **AV** or touch the screen.

# How to use the DVD player

## Operating the video

### Playing the video



- 1 Touch .





### Fast-forwarding/rewinding

It is possible to fast-forward or rewind through the video being played.

#### Using panel button

- 1 Press and hold  or  until a beep is heard.

-  : Advances the video
-  : Rewinds the video
- The main unit switches to the fast-forward (rewind) mode when the beep is heard and will continue fast-forwarding (rewinding) until your finger is removed from the switch.

#### Fast-forwarding/rewinding using the touch switches

- 1 Touch  or .

- The main unit switches to the fast-forward (rewind) mode when the beep is heard and will continue fast-forwarding (rewinding) until your finger is removed from the switch.



- Information for items such as touch switches will be displayed for about 6 seconds. Pressing **AV** or touching the screen will display them again.
- Depending on the disc, automatic playback may not function or playback may not function unless a menu recorded on the disc is selected. (Refer to "Operating the disc menu" on page 94.)

## Pausing the video

1 Touch **⏸**.

- While paused (**⏸**), briefly touching **⏪** will play in slow motion and touching **⏩** will play frame-by-frame.



## Stopping the video

1 Touch **■**.



# How to use the DVD player

## Operating the disc menu

It is possible to use the menu recorded on the disc.

1 Touch **NEXT** on the DVD operation screen.

2 Touch **MENU** or **TOP MENU**.

3 Touch **+**.

4 Touch **↑** **↓** **←** **→** and select the video to play.

5 Touch **ENTER**.

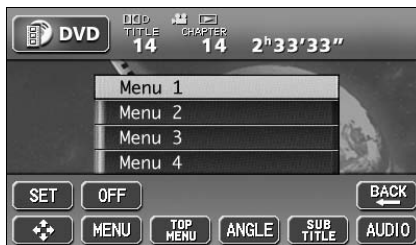

Recorded menu items will differ by disc. Some functions may not perform during operation because playback is following disc content specifications.

## Turning off the DVD

1 Press **MENU**.

2 Touch **AUDIO OFF**.

- Touching **AUDIO OFF** again on the MAIN MENU screen will start resume playback.

## Searching for a desired chapter

It is possible to search for a particular video segment by title and chapter or by menu number (number for divided segments).

### Searching by chapter

1 Press **▶▶** or **◀◀**.

- **▶▶** : Selects next chapter
- **◀◀** : Selects previous chapter



### Searching by title number

1 Touch **SEARCH** on the DVD operation screen.

- The title number input screen will be displayed.

2 Input the title number by touching

**-**, **+**, **-10**, **+10**.

- Touching **-** or **+** changes the title number by ones.
- Touching **-10** or **+10** changes the title number by tens.

3 Touch **ENTER**.



# How to use the DVD player

## Searching by menu number

1 Touch **NEXT** on the DVD operation screen.

2 Touch **+**.



3 Touch **NUMBER**.

- The menu number input screen will be displayed.

4 Input the menu number by touching

**-**, **+**, **-10**, **+10**.

- Touching **-** or **+** changes the menu number by ones.
- Touching **-10** or **+10** changes the menu number by tens.

5 Touch **ENTER** on the DVD operation screen.





## Changing the touch switch display

Display of the touch switches can be changed or turned off.

### Turning off the touch switches

- 1 Touch **OFF** on the DVD operation screen.

- Pressing **AV** or the touching the screen will display the touch switches again.



### Changing the touch switch display locations

- 1 Touch **NEXT** on the DVD operation screen.

- 2 Touch **+**.

- 3 Touch **POSITION**.

- The position of the touch switch will move up or down with each touch of the screen.



**POSITION** ↑ ↓ **POSITION**



# How to use the DVD player

## Switching between screen display and audio

It is possible to change the language for subtitles, the language for audio and the display angle for the video being played.

### Switching the video angle

When several angles of a scene are recorded on a disc, the angle can be switched.

1 Touch **NEXT** on the DVD operation screen.

2 Touch **ANGLE** when the multi-angle mark is displayed.

- The angle number will be displayed.



3 Touch **ANGLE**.

- The angle number will change and the angle of the video will be switched.



Each time **ANGLE** is pressed, the angle will change in order from among the angles recorded on the disc.

## Switching subtitle languages

When subtitles in several languages are recorded on a disc, the subtitles can be switched.

1 Touch **NEXT** on the DVD operation screen.

2 Touch **SUB TITLE**.

- The subtitle number and language will be displayed.



3 Touch **SUB TITLE**.

- Switches the subtitle number each time the touch switch is touched and switches the displayed subtitle language.



- Each time **SUB TITLE** is pressed, the subtitle language will change in order from among the subtitles recorded on the disc.
- Depending on the disc, it may only be possible to change subtitles from the top menu.

# How to use the DVD player

## Switching dubbed audio language

When dubbed voices in several languages are recorded on a disc, the voices can be switched.

**1** Touch **NEXT** on the DVD operation screen.

**2** Touch **AUDIO**.

- The audio number and language will be displayed.



**3** Touch **AUDIO**.

- The audio number will change and the language of voices being played will be switched.



- Each time **AUDIO** is pressed, the audio language will change in order from among the languages recorded on the disc.

Language 1 → Language 2 → Language...

- Depending on the disc, it may only be possible to change the language from the top menu.
- The dts format is not supported by this equipment, so no audio will be emitted when "dts audio" is selected by a disc having dts audio recorded on it. In this case, select "Dolby Digital audio" if it is definitely recorded on the DVD video.
- dts is a registered trademark of the US company Digital Theater Systems, Inc.

## Setting the DVD player

The language preference for voices, subtitles and menu display used during DVD playback can be set in advance. Optional display of the multiple angle mark, viewer restriction and other functions can also be set.

1 Touch **NEXT** on the DVD operation screen.

2 Touch **SET**.



3 Touch **SETUP**.

- The SET UP screen will be displayed.



4 Touch any of the touch switches.  
Settings can be made for the following items.

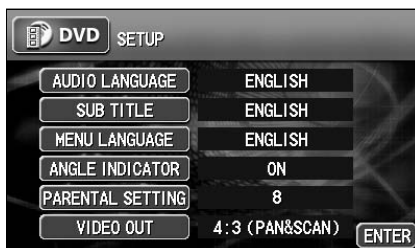

Touch switch	Function	Page
<b>AUDIO LANGUAGE</b>	Sets the language of voices for video playback.	102
<b>SUB TITLE</b>	Sets the language of subtitles for video playback.	103
<b>MENU LANGUAGE</b>	Sets the language of displayed menus.	104
<b>ANGLE INDICATOR</b>	Sets display/non-display of multiple angle mark.	105
<b>PARENTAL SETTING</b>	Restricts the types of DVD videos that can be played.	106
<b>VIDEO OUT</b>	Sets screen size.	107

# How to use the DVD player



Pressing one of the switches that can switch screens ( **AV** or **MENU** ) without touching **ENTER** after changing settings with the default setting screen will stop playing of the DVD. Touch  on the operation screen to start playback again. (Refer to page 92.)

## Setting the audio language

The preferred language for the video being played can be selected.

**1** Touch **AUDIO LANGUAGE** on the SET UP screen.

**2** Touch the preferred language.

- Touching **OTHER** enables setting of a language other than those displayed on the screen.



## Input a code

**1** Touch **OTHER** on the AUDIO LANGUAGE setting screen.

**2** Input a language code.

- Refer to "Table of language codes" on page 108 for language codes.

**3** Touch **ENTER**.



## Subtitle language setting

The preferred subtitles for the video being played can be selected.

**1** Touch **SUB TITLE** on the SET UP screen.

**2** Touch the preferred language.

- Touching **OTHER** enables setting of a language other than those displayed on the screen.
- Touching **OFF** plays the video with no subtitles on the screen.



## Input a code

**1** Touch **OTHER** on the SUB TITLE setting screen.

**2** Input a language code.

- Refer to "Table of language codes" on page 108 for language codes.

**3** Touch **ENTER**.



Language switching cannot be performed if the selected language is not recorded on the disc.

# How to use the DVD player

## Menu language setting

Allows selection of a preferred menu language from those recorded on the disc.

**1** Touch **MENU LANGUAGE** on the SET UP screen.

**2** Touch the preferred language.

- Touching **OTHER** enables setting of a language other than those displayed on the screen.



## Input a code

**1** Touch **OTHER** on the MENU LANGUAGE setting screen.

**2** Input a language code.

- Refer to "Table of language codes" on page 108 for language codes.

**3** Touch **ENTER**.





## Setting display of multi-angle mark (angle selection mark)

The multi-angle mark can be set to display/not display for the video being played.

Multi-angle mark



**1** Touch **ANGLE INDICATOR** on the **SET UP** screen.

- Each time ANGLE INDICATOR is pressed, the condition will switch between "ON" and "OFF".

**2** Touch **ENTER**.

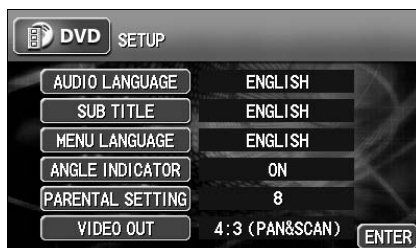

- Language switching cannot be performed if the selected language is not recorded on the disc.
- Setting multi-angle mark display to "ON" will display the multi-angle mark in the upper right corner of the screen when multiple angles are available on the disc.

# How to use the DVD player

## Viewer restriction setting

This function allows restriction of viewing so that discs with adult themes or violent scenes will not be available to children. Viewer restriction can be set at different levels to match restriction ratings.

**1** Touch **PARENTAL SETTING** on the SETUP screen.

**2** Enter a password (4 digits) by touching one number at a time.

**3** Touch **ENTER**.

**4** Touch the preferred restriction level.

**5** Touch **ENTER**.

- If you touched **ENTER** after inputting a wrong password, eject the disc once to set the viewer restriction setting again.

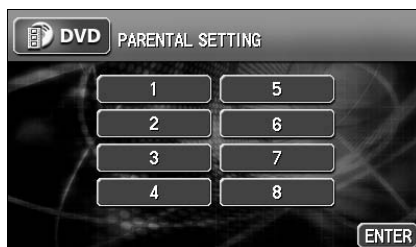
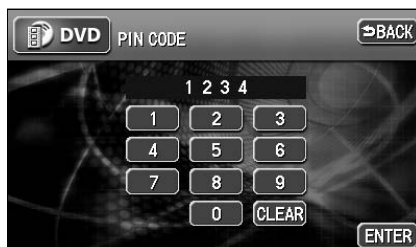

- Restriction cannot be set for discs not having a viewer restriction level recorded.
- Be sure to enter a password number. If a number is not entered, setting of viewer restriction will not be possible.
- The password to be shown in the upper section will be displayed as ---- when a password has not yet been set.
- Once the password has been set, the password will be required for subsequent use of this function. Please do not forget the password. If the password is forgotten, the default condition (no password set) can be restored by touching **CLEAR** 10 times.
- Viewer restriction levels are classified in 3 types.
 

Level 1 .....	Plays only DVD software intended for children. (Playing of DVD software intended for general audiences or adult audiences is prohibited.)
Level 2 - 7 .....	Plays only DVD software intended for children or general audiences. (Playing of DVD software intended for adult audiences is prohibited.)
Level 8 .....	Plays all DVD software. (Factory setting)

## Changing video output

**1** Touch **VIDEO OUT** on the SETUP screen.

- Each time VIDEO OUT is pressed, the screen size will be changed in the order shown below.

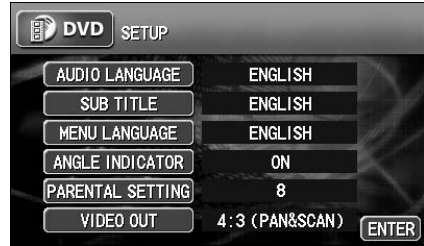
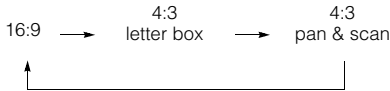

**2** Touch **ENTER**.

- **16:9**

The video is displayed in normal wide size. DVD software recorded in 4:3 size will be displayed with black left and right edges or will be expanded to the left and right.

- **4:3 (letter box)**

The video is displayed with black upper and lower edges.

DVD software recorded in 4:3 size will be displayed exactly at screen size (4:3).

- **4:3 (pan & scan)**

The video is displayed with right and left edges cut off. DVD software recorded in 4:3 size will be displayed exactly at screen size (4:3).



When another monitor such as the rear seat monitor is being used, the size of the video being displayed in the rear seat monitor will differ according to the video output size that is set by this equipment (front).



Viewing of wide screen modes is permitted when limited to the personal entertainment of the user, but caution is required when using technologies such as image compression and expansion for the purpose of commercial benefit or public presentation may infringe upon the rights of the copyright holder being protected by applicable copyright law.

# How to use the DVD player

## Table of language codes

These codes are used to specify the language for audio tracks, subtitles and on-screen menu displays.

Input code	Language
1001	Japanese
0514	English
0618	French
0405	German
0920	Italian
0519	Spanish
1412	Dutch
1821	Russian
2608	Chinese
1115	Korean
0512	Greek
0101	Afar
0102	Abkhazian
0106	Afrikaans
0113	Amharic
0118	Arabic
0119	Assamese
0125	Aymara
0126	Azerbaijani
0201	Bashkir
0205	Byelorussian
0207	Bulgarian
0208	Bihari
0209	Bislama
0214	Bengali
0215	Tibetan
0218	Breton
0301	Catalan
0315	Corsican
0319	Czech
0325	Welsh
0401	Danish
0426	Bhutani
0515	Esperanto
0520	Estonian
0521	Basque
0601	Persian
0609	Finnish
0610	Fiji
0615	Faroese
0625	Frisian
0701	Irish
0704	Scots-Gaelic
0712	Galician
0714	Guarani
0721	Gujarati

Input code	Language
0801	Hausa
0809	Hindi
0818	Croatian
0821	Hungarian
0825	Armenian
0901	Interlingua
0905	Interlingue
0911	Inupiak
0914	Indonesian
0919	Icelandic
0923	Hebrew
1009	Yiddish
1023	Javanese
1101	Georgian
1111	Kazakh
1112	Greenlandic
1113	Cambodian
1114	Kannada
1119	Kashmiri
1121	Kurdish
1125	Kirghiz
1201	Latin
1214	Lingala
1215	Laothian
1220	Lithuanian
1222	Latvian
1307	Malagasy
1309	Maori
1311	Macedonian
1312	Malayalam
1314	Mongolian
1315	Moldavian
1318	Marathi
1319	Malay
1320	Maltese
1325	Burmese
1401	Nauru
1405	Nepali
1415	Norwegian
1503	Occitan
1513	Oromo
1518	Oriya
1601	Panjabi
1612	Polish
1619	Pashto
1620	Portuguese

Input code	Language
1721	Quechua
1813	Rhaeto-Romance
1814	Kirundi
1815	Romanian
1823	Kinyarwanda
1901	Sanskrit
1904	Sindhi
1907	Sangho
1908	Serbo-Croatian
1909	Sinhalese
1911	Slovak
1912	Slovenian
1913	Samoan
1914	Shona
1915	Somali
1917	Albanian
1918	Serbian
1919	Siswati
1920	Sesotho
1921	Sundanese
1922	Swedish
1923	Swahili
2001	Tamil
2005	Telugu
2007	Tajik
2008	Thai
2009	Tigrinya
2011	Turkmen
2012	Tagalog
2014	Setswana
2015	Tonga
2018	Turkish
2019	Tsonga
2020	Tatar
2023	Twi
2111	Ukrainian
2118	Urdu
2126	Uzbek
2209	Vietnamese
2215	Volapuk
2315	Wolof
2408	Xhosa
2515	Yoruba
2621	Zulu

# MEMO



# How to use the VTR

Connecting a VTR deck enables watching of video tapes. Videos can be played only if the vehicle is completely stopped in a safe location with the parking brake set and the ignition switch turned to ON or ACC. (Only sound can be heard if a VTR is played while the car is in motion.)

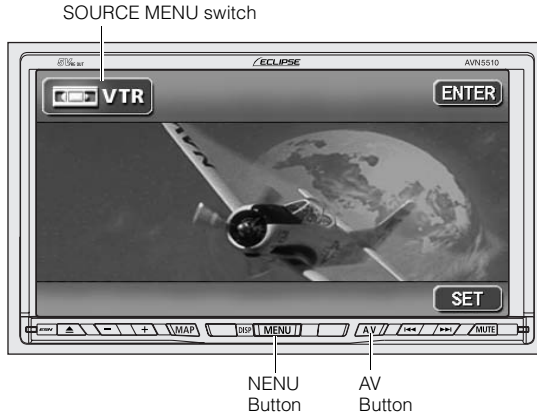

## Viewing the VTR

**1** Press **MENU**.

**2** Touch **SOURCE**.

**3** Touch **VTR**.

- The VTR screen will be displayed.
- Press **AV** or touch the screen to display the VTR operation screen.
- By touching **ENTER** on the VTR operation screen, the display will show video again.

## Switching the VTR setting screen

Various setting mentioned below can be made by switching to the VTR setting screen.

- Tone control such as EQ and POS.
- Switching the screen mode (wide mode)

**1** Touch **SET** on the VTR operation screen.

- By touching **BACK**, the display will return to the VTR operation screen.

## Turning off the VTR mode

**1** Press **MENU**.

**2** Touch **AUDIO OFF**.

- Pressing PWR again will resume playback.
- Video can also be played by touching **SOURCE** and then touching **VTR**.



- After switching to the VTR operation screen, touch switches will be displayed for about 6 seconds. Pressing **AV** will display them again.
- The VTR operation screen will be displayed by touching the screen, even when the VTR is playing.
- Depending on the kind of devices connected, the video image may not be displayed correctly.

# How to use the TV

The unit can be used as a TV if a TV tuner (sold separately) is connected to the unit. For safety reasons, the TV can be viewed only when the ignition is switched to ON or ACC and the vehicle is completely stopped with the parking brake set. If TV mode is selected while the vehicle is in motion, or while the display is closed, only sound will be output.



## Watching a TV

- 1 Press **MENU**.
- 2 Touch **SOURCE**.
- 3 Touch **TV**.

## Selecting channels

### Manual selection

- 1 Press **▶▶ / ▲** or **◀◀ / ▼**.
  - Pressing the switch once moves the channel one step up or down.
    - ▶▶ / ▲**: Raises the channel
    - ◀◀ / ▼**: Lowers the channel



## Automatic selection

1 Press and hold **▶▶** / **▲** or **◀◀** / **▼** until you hear a beep.

- The channel that is closest to the current channel will be searched for automatically, and searching will stop when the channel is received. To stop the search before a channel is found, press the button again.

## Selection using prest switches

1 Touch a preset switch that already has a channel recorded.

- See "Saving channels" shown below for more information.



After switching to the TV operation screen, touch switches will be displayed for about 6 seconds. Touch the screen to display them again.

# How to use the TV

## Saving channels

There are two modes for saving channels, manual and AUTO.P. These modes operate independently.

### Saving manually

Make sure "AUTO.P" is not displayed in the upper part of the screen.

- If displayed, touch **AUTO.P** to switch to manual.

**1** Use manual tuning or automatic tuning to select the channel to be saved.

**2** Choose a preset switch and touch it until you hear a beep.

- The channel is set. Touch the preset switch to tune in the selected channel.



### Saving with AUTO.P

**1** Touch **AUTO.P** until you hear a beep.

- The AUTO.P function will activate and start automatically selecting channels. You will hear a beep when the automatic selection of channels is completed.

Touch **AUTO.P** again to return to the channels originally saved.

### Changing stations saved by AUTO.P

**1** Use manual tuning or automatic tuning to select the channel to be saved.

**2** Touch the preferred preset switch until you hear a beep.

## About AUTO.P

Because the AUTO.P function can be used to temporarily save channels for the preset switches, channels saved manually will remain in memory even if AUTO.P is used. Manually saving channels that are used regularly allows them to be restored even after AUTO.P has been used, such as after traveling.

Touching **AUTO.P** while AUTO.P is operating or after it has been used will return the preset memories to their previous settings. (The channels saved with AUTO.P will be deleted.) The diagram below shows how to switch between AUTO.P and manual.

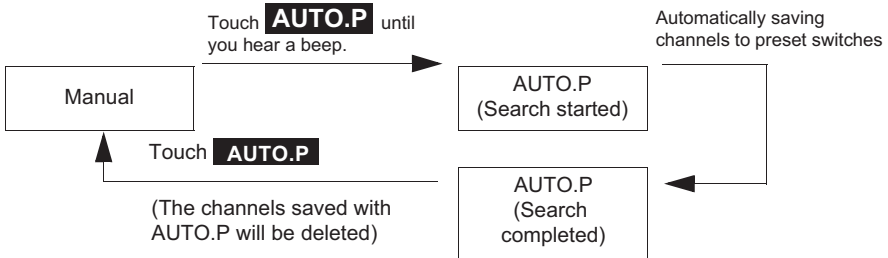

- AUTO.P may not automatically receive channels if TV waves in the surrounding area are weak.
- A frequency saved with the tuning switch may not match the channel saved with AUTO.P even though the signal is received from the same station.
- Due to conditions for receiving TV waves, saved channels may differ even when the AUTO.P switch is operated repeatedly in the same location.
- Up to eight channels with good signal reception are automatically saved in channel order (low to high).
- When less than eight channels capable of reception are found, nothing is saved for the remaining preset switches.

# How to use the TV

## Switching the TV setting screen

Various setting mentioned below can be made by switching to the TV setting screen.

- Switching the display mode (wide mode)
- Memorizing channel number manually.

### 1 Touch **SET**.

- By touching **BACK**, the display will return to the TV operation screen.



## To end TV mode

### 1 Press **MENU**.

### 2 Touch **AUDIO OFF**.

- Touching **AUDIO OFF** again on the MAIN MENU screen to turn on the TV and resume reception of the channel received before power was turned off.

# MEMO



# About the steering wheel switches

On vehicles equipped with steering wheel switches, these easy-access switches can be used to perform the main audio and other operations.

(For details of the steering wheel switch, please contact your local dealer.)

## Function names and summaries

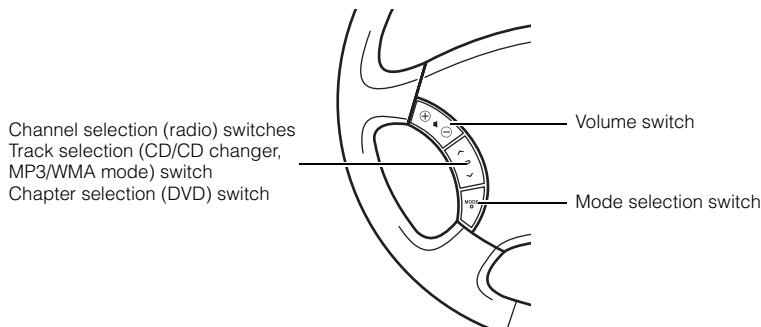

## Common operations

Switch	Name	Function	Explanation of operation
(+) (-)	Volume switch	Each momentary actuation of these switches changes the volume one step. Hold a switch down for a continuous volume change.	(+): Volume UP (-): Volume DOWN
(MODE)	Mode selection switch	<ul style="list-style-type: none"> <li>When the power is OFF, pressing this switch turns it ON.</li> <li>The mode changes. FM1 → FM2 → FM3 → CD → MP3/WMA → (CD changer) → DVD → (TV) → (VTR) → (iPod) → AM → (SIRIUS1) → (SIRIUS2) → (SIRIUS3) → (SIRIUS4) → return to FM1</li> <li>Press the switch until it beeps to turn the power OFF.</li> </ul>	Each time <b>(MODE)</b> is pressed while the power is ON, the mode changes.

( ) : Optional

## **Radio operations**

Switch	Name	Function	Explanation of operation
(^) (v)	Channel selection switch	<ul style="list-style-type: none"> <li>• Calls up the preset broadcast channels in order.</li> <li>• Pressing the switch until it beeps starts automatic channel selection.</li> </ul>	Pressing (^)/(v) briefly: Used to select the next (previous) preset channel Pressing (^)/(v) for longer: Starts automatic channel selection.

## **CD player operations**

Switch	Name	Function	Explanation of operation
(^) (v)	Track selection switches	Selects the next track or previous track or beginning of the current track.	(^): Used to select the next track. (v): Used to select the previous track.

## **SIRIUS satellite radio tuner operations**

Switch	Name	Function	Explanation of operation
(^) (v)	Channel selection switches	<ul style="list-style-type: none"> <li>• Selects the next preset channel or previous preset channel.</li> <li>• Pressing the switch until it beeps to start searching channels within the selected category.</li> </ul>	Pressing (^)/(v) briefly: Used to select the next (previous) preset channel Pressing (^)/(v) for longer: Starts searching channels within the selected category.

## **MP3/WMA Player operations**

Switch	Name	Function	Explanation of operation
(^) (v)	Track selection switches	<ul style="list-style-type: none"> <li>• Selects the next file or previous file.</li> <li>• Pressing the switch until it beeps to go to the next folder or previous folder.</li> </ul>	Pressing (^)/(v) briefly: Used to select the next (previous) file Pressing (^)/(v) for longer: Used to select the next (previous) folder

## About the steering wheel switches

### DVD operations

Switch	Name	Function	Explanation of operation
(^) (v)	Chapter selection switches	Selects the next chapter or previous chapter.	(^): Used to select the next chapter. (v): Used to select the previous chapter.

### CD changer operations

Switch	Name	Function	Explanation of operation
(^) (v)	Track selection switches	<ul style="list-style-type: none"> <li>Selects the next track or previous track or beginning of the current track.</li> <li>Press the switch until it beeps to go to the next disc or previous disc.</li> </ul>	Pressing (^)/(v) briefly: Used to select the next track or previous track. Pressing (^)/(v) for longer: Used to select the next disc or previous disc.

### TV operations

Switch	Name	Function	Explanation of operation
(^) (v)	Channel selection switch	<ul style="list-style-type: none"> <li>Pressing the switch until it beeps starts automatic channel selection.</li> </ul>	Pressing (^)/(v) for longer: Starts automatic channel selection.



# MEMO



## ***How to use an optional remote control (RMC105)***



Caution

### **Precautions in use of the remote control**

- Be careful when handling the remote control, especially because it is small and light. Dropping or striking it hard may damage it, wear out the battery or cause a malfunction.
- Keep the remote control free of moisture, dust and water. Do not subject it to shock.
- Do not place the remote control unit where it will get hot, such as on the dashboard or near a heater vent. Allowing the remote control unit to overheat may warp its case or cause other problems.
- Do not operate the remote control unit while driving because doing so could cause an accident.
- When using the remote control, point it directly at the remote control light receptor.
- The light receptor may not operate correctly if it is exposed to bright light such as direct sunlight.
- Remove the batteries from the remote control unit whenever it is not to be used for a long time.

### **Cleaning the remote control**

- Use a dry cloth to keep the unit clean. If the remote control unit gets extremely dirty, clean it with a cloth moistened in diluted liquid detergent. Do not use alcohol or thinner; these compounds may damage the finish.
- In no event should benzine or thinner be used. These substances will damage the case or finish.



ATTENTION

TU, DISC and AUX buttons do not work.

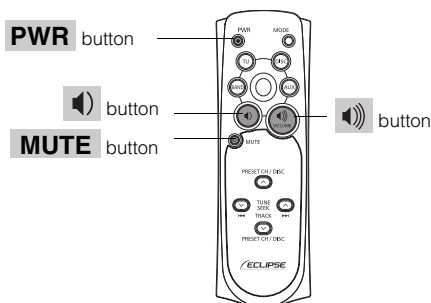
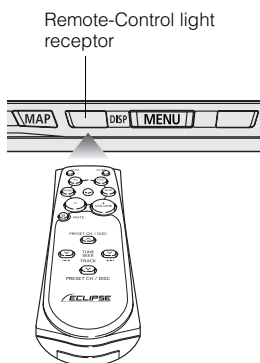

## Turning the power on/off

When the power is turned on, the state used when the power was turned off such as CD and tuner will be restored.

**1** Press **PWR**.



- The power turns on or off each time the button is pressed.



When the main unit is shut down, the remote control will not work.

## Adjusting the audio volume

**1** Press  or .

-  button: Increases the volume.
-  button: Decreases the volume.

### *Muting the Volume*

Press **MUTE** to cut the volume or restore it instantly.

# How to use an optional remote control (RMC105)

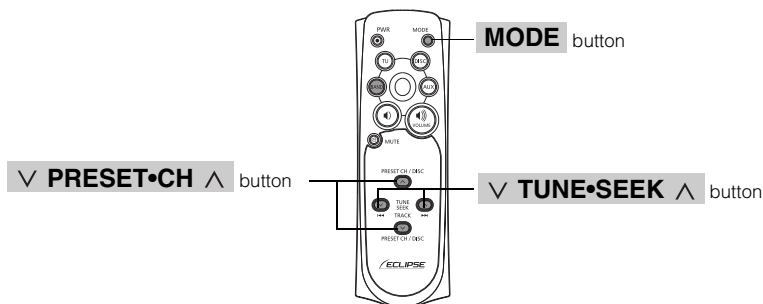

## Switching playback modes

**1** Press **MODE**.

- Press the button to switch modes in the following sequence:

→ AM → FM → CD(MP3/WMA) → CD Changer → DVD → TV → VTR → SIRIUS → iPod

## How to play the tuner

Select the tuner mode first.

### Selecting a station (manually or automatically)

A short press of the button will allow manual station tuning. Pressing for more than one second will start automatic tuning.

**1** Press **∇ TUNE•SEEK ▲**.

- ▲** button: Tunes to higher frequency stations.
- ∇** button: Tunes to lower frequency stations.

### Selecting preset stations

A total of six stations may be selected (preset tuning) out of those already set in memory through the main unit. (Refer to the Section "Saving radio stations" on page 56)

This function is not available for TV.

**1** Press **∇ PRESET•CH ▲**.

- ▲** button: Select the next higher number preset button.
- ∇** button: Select the next lower number preset button.

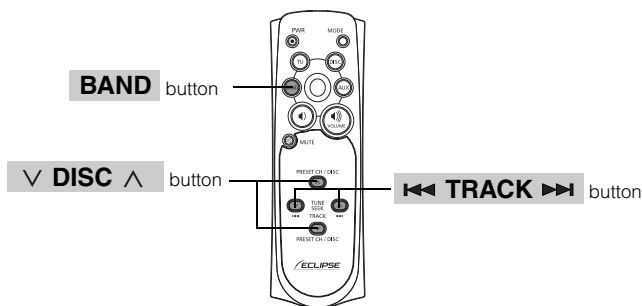

## How to play CDs

### Switching CD Changer modes

Select the CD Changer mode first.

**1** Press **BAND**.

- When two CD changers are connected, press **BAND** to change modes from CD changer 1 → CD changer 2.

### Advancing to the next track or returning to the beginning of the track being played

Select the CD or CD Changer mode first.

**1** Press **◀◀ TRACK ▶▶**.

- **▶▶** button: Skips to the next track.
- **◀◀** button: Returns to the beginning of the track being played. (Press repeatedly to move to previous tracks.)



Hold **▶▶** down to fast forward, or **◀◀** to rewind through the track being played.

### Skipping to the next or previous disc

Select the CD or CD Changer mode first.

**1** Press **∇ DISC ▲**.

- **▲** button: Selects the next higher number disc.
- **∇** button: Selects the next lower number disc.

# How to use an optional remote control (RMC105)

## Replacing the battery



To prevent accidents, store batteries out of the reach of children. If a child has swallowed one, consult a doctor immediately.

Use two AAA-size batteries.

- 1** Remove the back cover of the remote control unit by gently pressing and sliding it in the direction indicated by the arrow.

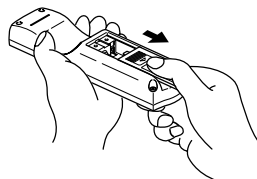

- 2** Install the two batteries provided into the compartment as illustrated.

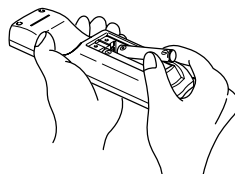

- 3** Return the back cover into place by sliding it in the direction indicated by the arrow.

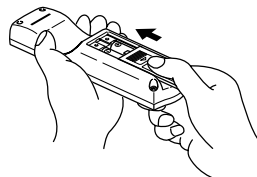

- The battery life is approximately one year. If the remote control unit does not operate correctly or if the button lamp gets dim, replace the batteries.
- Be sure to orient the batteries correctly so that the positive and negative poles match the diagram.
- Do not use one new battery and one old one; use two new batteries.
- Use only two of the same kind of battery.
- If any liquid is seen leaking from the batteries, remove both batteries and dispose of them properly. Thoroughly clean the battery compartment with a dry cloth. Then install new batteries.

# MEMO



# Information you should know

## If one of these messages appears

If any of the following messages are displayed, check the equipment while referring to the Cause and Corrective action columns.

Messages	Cause	Corrective action
CD SEEK	The CD changer is searching for discs when a magazine has been set in the CD changer.	Wait until the unit has finished identifying the type of disc.
CD DOOR OPEN	The door of the CD changer is open.	Close the door of the CD changer.
DISC CHECK	The CD/MP3-WMA/DVD is dirty or is upside down.	Clean the disc if it is dirty. Insert the disc correctly if it is upside-down.
NO DISC NO CD	There is no disc in the CD/MP3-WMA/DVD player or CD changer.	Load a music disc (1).
CD ERROR DVD ERROR DISC ERROR	The CD/MP3-WMA/DVD player or CD changer is not operating for some reason.	Eject the disc.
CD ERROR DVD ERROR DISC ERROR	The temperature of the CD/MP3-WMA/DVD player or CD changer has become unusually high.	Without performing any other operations, wait until the temperature comes down (2).
NO CD MAGAZINE	There is no magazine in the CD changer.	Load a magazine.
CD ○○ CHECK	The ○○th CD in the CD changer cannot be read.	Check for a properly loaded music CD.
PASS CODE INCORRECT	This message is displayed when the pass code that has been entered is not correct.	Enter the correct pass code.
PARENTAL LOCK ENABLED	Viewing restrictions are enabled.	Change the setting for viewing restrictions and start again. (Refer to page 106.)
CURRENTLY THIS FUNCTION IS DISABLED	A function that has been disabled was selected with the menu.	Follow the directions on the screen and start again.
CURRENTLY THIS FUNCTION IS DISABLED	A function that cannot be used while the vehicle is in motion was selected.	Stop the vehicle.
INVALID CODE	A number not supported was input for selecting a language code.	Input a valid language code.
REGION CODE ERROR	The region code (controlled region for playback) of the disc isn't acceptable.	Check that the DVD has a region code that can be played on this equipment. (Refer to page 88.)
REQUESTED CHAPTER OR TITLE NOT FOUND	The selected chapter/title does not exist.	Select a chapter/title that is on the disc.
EJECT LOCK	The loaded disc cannot be ejected.	Contact the Eclipse dealer at (800)-233-2216.



Messages	Cause	Corrective action
ANTENNA	The SIRIUS antenna is disconnected.	Check the connection of the SIRIUS antenna.
ACQUIRING	Displayed when the signal is lost (during access).	Try receiving the signal again in the place where there are no obstacles.
CALL888-539-SIRIUS	You are tuned to a valid channel but you are not subscribed to that channel.	Subscribe to SIRIUS. Or, check/change your subscription plan.
SUB UPDATED	Displayed when your channel subscription has been accepted and your status is being updated to allow you to receive the channels.	After this message is displayed, the channels for which you do have a subscription can be received.
INVALID	Displayed when you are tuned to a channel that you cannot receive.	Tune to channels that you can receive.
UPDATING	Displayed while the channel map is being updated.	After this message is displayed, subscribe to SIRIUS. The channels for which you do have a subscription can be received.

- 1: If the unit will not work after the disk is ejected, contact your local retailer.
- 2: If this happens, wait for a while. When the temperature inside the equipment returns to normal, the message will disappear and playback will start. If the message does not disappear after a long period of waiting, contact the place of purchase.

# Information you should know

## Before asking for repairs

Slight differences in operation can sometimes be mistaken for malfunctions, so check the following table before asking for any repairs.

If the following fail to solve the problem, contact the place of purchase.

Problem	Possible reason	Corrective action
The screen is dark for a brief period when the power is turned on at low temperatures.	This is a characteristic of LCDs.	This is not a malfunction. Wait for a brief period.
The display is distorted for a brief period after the power is turned on.	This is a characteristic of LCD backlighting.	This is not a malfunction. The display will stabilize after a brief period.
No sound comes out.	Volume is poorly adjusted or MUTE is functioning.	Press the volume switch and check volume. Or cancel MUTE.
Sound comes out of only one side (left or right, front or back).	A speaker wire is disconnected.	Check the connections of the speaker wires.
	Volume is poorly adjusted.	Check the balance and fader adjustments.
Sound quality does not change even after making adjustments.	The adjusted audio quality is not included in the radio broadcast or disc.	Check by changing the radio station or disc.
A CD/DVD will not go into the deck.	Power is not turned on.	Turn the vehicle ignition switch to [ACC] or [ON].
	A disc is already inserted and you are trying to insert a second disc.	Eject the previously inserted CD/DVD and insert the preferred CD/DVD.
A CD/DVD cannot be played.	There is water condensation in the equipment.	Do not use the equipment for a while and then try using it again. (Refer to pages 18.)
	There is a large scratch or warp in the CD/DVD.	Insert a different CD/DVD.
	The CD/DVD is very dirty.	Clean the CD/DVD. (Refer to page 19.)
	The CD/DVD is upside down.	Insert the CD/DVD with the proper orientation.
A non-supported type of CD/DVD has been inserted.		Insert a CD/DVD that is supported by the deck. (Refer to pages 18.)
A <b>CDCHANGER1</b> / <b>CDCHANGER2</b> is not displayed on the screen.	The CD changer is not completely connected.	Check the connections to the CD changer.
Audio is output, but not video.	The screen has been turned off with the screen OFF button.	Press <b>AV</b> or <b>MAP</b> . (Refer to page 45.)
Audio is output, but not DVD video. (With vehicle stopped.)	The parking brake has not be set.	Set the parking brake.
Neither video nor audio is output.	The vehicle ignition switch has not been turned on.	Turn the vehicle ignition switch to [ACC] or [ON].
	The connection wires and cables are not completely connected.	Check the connections to each connection wire and cable.
There is a point of light on the display.	At least 99.99% of the pixels on the LCD panel are effective, but it is possible that 0.01% of the pixels may not light or may stay lighted.	This is not a defect, so please use the equipment in this condition.

# Others

---

## Products equipped with Dolby Digital

Manufactured under license from Dolby Laboratories.

"Dolby" and the double-D symbol are trademarks of Dolby Laboratories.



## Products equipped with Macrovision

This unit includes copyright protection technology used in accordance with US patents and other intellectual property rights owned by Macrovision Corporation and other entities. Use of this copyright protection technology requires approval from Macrovision Corporation and the technology must not be used for audiovisual purposes aside from general household use without special approval from Macrovision Corporation. Modification and disassembly of this technology is prohibited.

# Glossary

<b>CD-R</b> <b>(Compact Disc Recordable)</b>	This is a disc that can only be recorded once. Recorded data cannot be deleted. There are two types of CD-R, one having capacity of 650MB (74 minutes of music), the same as a regular CD, and the other having capacity of 700MB (80 minutes of music).
<b>CD-DA</b> <b>(Compact Disc Digital Audio)</b>	This disc is the standard for recording and playing of music data. One track is recorded with one song, and a maximum of 74 minutes can be used with the CD.
<b>CD-RW</b> <b>(Compact Disc ReWritable)</b>	This disc uses a phase transformation method that enables recording and deleting of data as many times needed. Capacity is 700MB (80 minutes of music).
<b>EQ (Equalizer)</b>	This enables setting of stronger or softer playing of sounds throughout the high to low range of the sound. Levels can be adjusted to personal preference, enhancing enjoyment of the music.
<b>MP3</b> <b>(MPEG-1 Audio Layer-3)</b>	"MP3" is the abbreviation for "MPEG Audio Layer 3," which is the standard format for compression of audio data. MP3 technology compresses sound in the range inaudible to the human ear, producing a file one tenth the size of the original.
<b>LPCM</b> <b>(Linear PCM)</b>	This is an abbreviation for Linear Pulse Code Modulation, a signal recording method used with music CDs. A music CD is recorded at 44.1kHz/16 bit, but a DVD is recorded at 48kHz/16 bit ~ 96kHz/24 bit, enabling a DVD to be played with higher sound quality than a music CD.
<b>MPEG</b>	This is an abbreviation for Moving Picture Experts Group and is pronounced "empeg". It is the international standard for moving image compression. With DVDs, this method is also used to compress and record digital audio.
<b>Copy Control CD</b>	This is a CD that has controls for preventing computers from copying and ripping (taking audio information recorded on a compact disc and using it as data to create a file).
<b>UDF</b> <b>(Universal Disc Format)</b>	This is one format for use with optical discs not reliant on the OS. It is used with media such as DVD and CD-RW.
<b>Track</b>	The single division for a song on a music CD is called a track.

<b>Viewing Restriction</b>	This is a DVD video function that "Restricts playing of discs that support viewing restrictions, in accordance with the regulated levels of each country." Restrictions differ by DVD video and may completely prevent playing of the video or may skip or insert alternate scenes for extreme scenes.
<b>Title</b>	This is the largest unit for divisions of video or songs recorded on a DVD video. Usually a single movie is treated as a title by video software and a single album (or song) is treated as a single title by music software. The consecutive numbers attached to titles are called title numbers.
<b>Chapter</b>	This is a unit for divisions of video or songs recorded on a DVD video, but it is a smaller unit than a title. A single title is made up of several chapters, and the consecutive numbers attached to chapters are called chapter numbers.
<b>Multi-Angle</b>	This is one feature of DVD video, where viewpoints of the same scene are changed by recording from several different angles (camera positions), allowing the viewer to select the preferred angle.
<b>Multi-Language</b>	This is one feature of DVD video, where the same scene is recorded with several different languages and subtitles, allowing the viewer to select the preferred language.
<b>Region Code</b>	DVD players and DVD discs have a region code that enables playing by geographic marketing regions, and a disc cannot be played if the number recorded on the disc is not included in the region codes of the player. Refer to page 88 for details on region codes.

# Index by topic

## About screen and sound adjustment

### [Regarding screen adjustment]

To make the audio operation screen or VTR screen easier to see

**"Adjusting/setting the screen"** ..... P44

To turn off the screen

**"Turning off the screen"** ..... P45

To change the wallpaper

**"Changing the wallpaper"** ..... P42

To set the screen to wide mode

**"Switching screen mode"** ..... P46

### [Regarding audio adjustment]

To change the volume

**"Adjusting main volume"** ..... P26

To turn on/off the guide tone used at switch operation

**"Setting the BEEP tone"** ..... P35

To adjust sound quality

- To change the acoustic environment of a performance

**"Setting DSP (acoustics)"** ..... P28

- To adjust high and low sounds

**"Adjusting EQ (equalizer)"** ..... P30

- To change the localization of sound according to your seating

**"Setting POS (position selector)"** ..... P33

- To adjust front/rear and left/right volume balance

**"Adjusting volume balance"** ..... P34

- To switch the bass enhancement

**"Switching the bass enhancement (Tru Bass)"** ..... P36

- To boost the high/low frequencies at low volume

**"Setting LOUDNESS"** ..... P36

- To change the phase and output level of woofer

**"Setting the sub-woofer"** ..... P37

- To adjust the MP3/WMA sound quality

**"Setting the harmonizer"** ..... P40

- To reproduce deep bass and localization of sound

**"Setting the Circle Surround II"** ..... P41

---

## About Using AM/FM radio

To play the radio	
<b>"Listening to the AM/FM radio"</b> .....	P48
To search for a radio station	
<b>"Selecting radio stations"</b> .....	P49
To save radio stations	
<b>"Saving radio stations"</b> .....	P51

---

## Usage when an HD Radio (IBOC) tuner is connected

To listen to HD Radio (IBOC)	
<b>"Listening to HD Radio (IBOC)"</b> .....	P54
To search for a radio station	
<b>"Selecting radio stations"</b> .....	P55
To save radio stations	
<b>"Saving radio stations"</b> .....	P56

---

## Usage when a SIRIUS satellite radio tuner is connected

To listen to SIRIUS broadcasts	
<b>"Listening to SIRIUS satellite radio"</b> .....	P57
To select a channel	
<b>"Selecting a channel by direct input"</b> .....	P58
<b>"Selecting from the available categories"</b> .....	P58

---

## About using the CD player/CD changer

To play a CD	
<b>"Listening to a CD"</b> .....	P60/76
To select a song or CD	
<b>"Selecting a song"</b> .....	P60
<b>"Selecting a CD"</b> .....	P77
When you don't know a song number or on what CD a song is located	
<b>"Searching for a song"</b> .....	P61

# Index by topic

---

"Searching for a song or CD from all CDs in changer" . . . . .	P77
To repeat the song or CD currently being played	
"Repeating a song" . . . . .	P61
"Repeating a song or CD" . . . . .	P78
To play songs in a different order	
"Playing songs in random order" . . . . .	P62
To fast-forward or rewind	
"Fast-forwarding/rewinding" . . . . .	P61

---

## About using the MP3/WMA player

To play MP3/WMA file	
"Playing MP3/WMA" . . . . .	P65
To select a music file	
"Selecting a music file" . . . . .	P65
When you want to return to a level or don't know the current level	
"Changing display of the current level" . . . . .	P66
To search for a music file	
"Searching for a music file" . . . . .	P66
To repeat a music file	
"Repeating the same music file" . . . . .	P67
To play files in a different order	
"Playing songs in random order" . . . . .	P67
To change the file information	
"About display of file information" . . . . .	P68
To learn about MP3/WMA	
"About MP3/WMA" . . . . .	P69
To learn about making MP3/WMA files	
"Making and playing MP3/WMA files" . . . . .	P75

---

## About using the iPod

To listen to iPod	
"Listening to iPod" . . . . .	P80
To select a song	
"Selecting a song" . . . . .	P81



To fast-forward or rewind	
<b>"Fast-forwarding/rewinding"</b> . . . . .	P81
To search for a song	
<b>"Searching for a song in various ways"</b> . . . . .	P82

---

## **About using the DVD player**

To play a DVD video	
<b>"Watching a DVD"</b> . . . . .	P91
To learn about discs	
• To learn about the marks displayed on discs and packages	
<b>"About marks displayed on discs"</b> . . . . .	P88
• To learn about discs that can be played	
<b>"About playable discs"</b> . . . . .	P87
• To learn about disc structures	
<b>"About DVD disc structure"</b> . . . . .	P89
To operate the menu recorded on a disc	
<b>"Operating the disc menu"</b> . . . . .	P94
To operate the video being played	
<b>"Operating the video"</b> . . . . .	P92
To select/search for a video	
<b>"Searching by chapter"</b> . . . . .	P95
<b>"Searching by title number"</b> . . . . .	P95
<b>"Searching by menu number"</b> . . . . .	P96
To change the display of touch switches	
<b>"Changing the touch switch display locations"</b> . . . . .	P97
To change subtitles, audio or the video angle	
<b>"Switching the video angle"</b> . . . . .	P98
<b>"Switching subtitle languages"</b> . . . . .	P99
<b>"Switching dubbed audio language"</b> . . . . .	P100
To set the player	
<b>"Setting the audio language"</b> . . . . .	P102
<b>"Subtitle language setting"</b> . . . . .	P103
<b>"Menu language setting"</b> . . . . .	P104
<b>"Setting display of multi-angle mark (angle selection mark)"</b> . . . . .	P105
<b>"Viewer restriction setting"</b> . . . . .	P106
<b>"Changing video output"</b> . . . . .	P107

# Index by topic

---

## About using the VTR

To use the VTR

**"How to use the VTR"** ..... P110

## About using the TV tuner

To watch TV

**"Watching a TV"** ..... P112

To search for a TV channel

**"Selecting channels"** ..... P112

To save TV channels

**"Saving channels"** ..... P114

## Useful functions

To operate the audio system by fingertip operations while driving

**"About the steering wheel switches"** ..... P118

## When something isn't clear

When you don't understand a screen message

**"If one of these messages appears"** ..... P128

When you think the equipment may have a problem

**"Before asking for repairs"** ..... P130

# MEMO



**INDEX****A**

- Adjusting sound quality ..... 27
- Adjusting the volume ..... 26
- ANGLE ..... 98
- AUTO.P ..... 51, 56
- AV ..... 23

**B**

- BRIGHT ..... 46

**C**

- CD-R (CD-Recordable) ..... 18
- CD-RW (CD-ReWritable) .... 18
- COLOR ..... 46
- CONTRST ..... 46

**D**

- Day screen ..... 45
- DISC RAND ..... 78
- DISC RPT ..... 78
- DISC SCAN ..... 77
- DSP ..... 28

**E**

- EQ (equalizer) ..... 30

**H**

- How to use an optional remote control ..... 122
- How to use HD Radio ..... 54
- How to use the AM / FM radio ..... 48

- How to use the CD changer ..... 76
- How to use the CD player ..... 60
- How to use the DVD player ..... 91
- How to use the MP3/WMA player ..... 64
- How to use the SIRIUS satellite radio ..... 57
- How to use the TV ..... 112
- How to use the VTR ..... 110

**I**

- IBOC ..... 54

**M**

- Multi-angle mark ..... 98

**N**

- Night screen ..... 45
- NORMAL mode ..... 47

**O**

- Operating the iPod ..... 80

**P**

- POS (position selector) ..... 33

**R**

- RAND ..... 62, 67
- RPT ..... 61, 67

## S

- Saving radio stations .... 51, 56
- SCAN ..... 61, 66
- Setting LOUDNESS ..... 36
- Setting the BEEP tone ..... 35
- Setting the Circle
- Surround II ..... 41
- Setting the harmonizer ..... 40
- Setting the  
opening screen ..... 43
- Steering wheel switches ... 118
- Switching subtitle  
languages ..... 99
- Switching the bass  
enhancement (Tru Bass) .... 36

## T

- TINT ..... 46
- Turning off the screen ..... 45

## V

- Volume balance ..... 34
- VOLUME switch ..... 26

## W

- Wallpaper (background) .... 42
- WIDE 1 mode ..... 47
- WIDE 2 mode ..... 47
- WIDE 3 mode ..... 47
- Woofers ..... 37