



Warnings and caution signs, illustrated below, are posted throughout this manual as well as on the device itself. They show safe and correct ways to handle the product so as to prevent personal injury to you and others, and to avoid damage to property. Before reading through the manual, take time to read through and learn the important information listed in this section.

Warnings and Cautions

* The images appearing on the screen may differ from those shown in this manual depending on the type of database used and when it was created.

	Warning	This symbol indicates a situation in which incorrect handling through disregard of a warning might result in death or serious personal injury.
	Caution	This symbol indicates a situation in which incorrect handling through disregard of a caution might result in personal injury or may result solely in damage to property.

The symbol shown below indicates important instructions or helpful information to keep in mind.

	A point it will be helpful to remember. Important points.
--	--

- Please read all materials that come with the product, such as manuals and warranties.
Eclipse will not be liable for unsatisfactory product performance due to failure to follow these instructions.
- Changes in product specifications may result in differences between the content of the manual and actual product features.

Table of Contents

Introduction

How to use this manual	12
Features	14
Before using the deck	16
About discs	18
About supported disc types	18
About handling discs	19
About new discs	20
About rental discs	20
About specially shaped discs	20
About disc accessories	20
About supported Memory Stick Duo types	21
About the Memory Stick Duo	21
About handling the Memory Stick Duo	22
About the LCD panel	22

Basic operation

Switching modes	24
Switching the mode	24
Switching the source when the display is retracted	24
Switching the source when the display is raised	24
Displaying operation screen	25
Operation screen of each mode	26
Adjusting the volume	27
Adjusting the main volume	27
Setting the BEEP tone	27
Adjusting sound quality	28
Displaying the sound adjustment screen	28
Adjusting EQ (equalizer)	31
Adjusting/saving EQ	31
Selecting a PEQ pattern from memory	33
Resetting EQ curves	33

Adjusting POS (Positioning selector)	34
Setting the balance	35
Setting LOUDNESS	36
Setting time alignment.	36
Selecting the type of vehicle (CAR TYPE)	37
Setting the tweeter (TWEETER)	37
Selecting rear speaker position (REAR SPEAKER)	38
Setting the harmonizer	38
Setting the background screen	39
Setting the Pic-CLIP	39
Uploading the image data from another source	40
Image data storage	42
Saving image data	44
Deleting image data	47
Setting opening screen	48
Setting the opening screen.	48
Adjusting/setting the screen	50
Switching the FUNCTION switch display.	50
Displaying the image adjustment screen	51
Setting daytime display to display when vehicle lights are on	52
Turning the screen off.	52
Adjusting image quality	53
Switching screen mode.	53
Setting the control panel	55
Switching the sub display.	55
Switching the control panel illumination.	55

How to operate the tuner

How to use the AM/FM radio	56
Listening to the AM/FM radio	56
Listening to the radio when the display is raised.	56
Listening to the radio when the display is retracted	56

Selecting radio stations.	57
Manual selection	57
Automatic selection.	57
Selection using preset switches	57
Selecting radio bands	58
Saving radio stations.	59
Saving manually.	59
Saving with AUTO.P	59
Changing stations saved by AUTO.P.	59
Operating RDS (Radio Data system)	61
Setting AF (Alternative Frequency)	61
Setting REG	62
Receiving traffic information	63
Setting TP (Traffic Programming).	63
Setting TA (Traffic Announcements)	64
Receiving traffic information.	65
EON (Enhanced Other Network) system	66
Reception of emergency broadcasts	66
Setting the volume for voice guidance	66
Setting PTY (Program Type)	67
Turning off the radio	67

How to operate the CD player

How to use the CD player.	68
Listening to a CD	68
Listening to a CD when the display is raised	68
Listening to a CD when the display is retracted	69
Selecting a track.	70
Fast-forwarding/rewinding	70
Repeating a track	70
Playing tracks in random order	70
Turning off the CD player	71

How to operate the MP3/WMA player

How to use the MP3/WMA player	72
Playing MP3/WMA files	73
Playing MP3/WMA files when the display is raised ...	73
Playing MP3/WMA files when the display is retracted	73
Selecting a music file.....	73
Selecting with the file change switches	73
Selecting with the TUNE/TRACK buttons	74
Fast-forwarding/rewinding	75
Changing display of the current level	75
Displaying the current level	75
Repeating the same music file	76
Playing music files in random order	76
About the file information display	77
Displaying folder/file names	77
Displaying file information	77
Turning off the MP3 player	77
About MP3/WMA files	78
Playable MP3 file standards	78
Playable WMA file standards	79
ID3 tag/WMA tag.....	80
Media.....	80
Supported disc formats.....	81
File names	82
Multi-sessions	82
Playing MP3/WMA files	82
MP3/WMA playing time display	82
Display order of MP3/WMA file/folder names	82
Making and playing MP3/WMA files.....	83
Downloading from Internet MP3/WMA music sites	83
Converting CD music to MP3/WMA files	83
Writing to CD-R/RW discs.....	83
Playing back CD-R/RW discs	83

How to operate the Memory Stick player

How to use the Memory Stick player	84
Listening to Memory Stick data	84
Listening to Memory Stick data when the display is raised.	84
Listening to Memory Stick data when the display is retracted	85
Selecting a track.	86
Fast-forwarding/rewinding	86
Repeating a track	86
Playing tracks in random order	87
Turning the Memory Stick off	87

How to operate the CD Changer

How to use the CD changer	88
Listening to a CD	88
Listening to a CD when the display is raised	88
Listening to a CD when the display is retracted	88
Selecting a track.	89
Fast-forwarding/rewinding	89
Selecting a CD	89
Repeating a track or CD	89
Repeating the current track	89
Repeating the current CD	89
Playing tracks in random order	90
Playing tracks on the current CD in random order.	90
Playing tracks on all CDs in random order	90
Turning off the CD changer.	91

How to operate the DVD player

Before using the DVD player	92
DVD video characteristics	92
About multiple languages	92
About multiple angles	92
About subtitles	93
About discs	93
About playable discs	93
About region codes	94
About marks displayed on discs	94
About DVD disc structures	95
Operation flow	96
How to use the DVD player	97
Watching a DVD	97
Operating the video	98
Playing the video	98
Fast-forwarding/rewinding	98
Fast-forwarding/rewinding using the panel buttons	98
Fast-forwarding/rewinding using the touch switches	98
Pausing the video	99
Stopping the video	99
Operating the disc menu	100
Turning off the DVD	100
Searching for a desired chapter	101
Searching by chapter	101
Searching by title number	101
Searching by menu number	102
Changing the touch switch display	103
Turning off the touch switches	103
Changing the touch switch display locations	103
Switching screen display/audio	104
Changing the angle	104
Switching subtitle language	105
Switching dubbed audio language	106
Setting the DVD player	107
Setting the audio language	108
Input a code	108

Subtitle language settings	109
Input a code	109
Menu language settings	110
Input a code	110
Setting the display of the multi-angle mark (angle selection mark)	111
Viewer restriction settings	112
Changing video output	113
Setting DVD individual monitor playback	114
Table of language codes	115

How to operate the VTR

How to use the VTR	116
Viewing the VTR	116
Switching to the VTR setting screen	117
Switching the display format	118
Turning off VTR mode	118

How to operate the unit when an optional 5.1 ch decoder/AV matrix unit connected

Before adjusting sound quality	119
Functions available when the optional 5.1 ch decoder/ AV matrix unit is connected	119
About parametric EQ	120
About time alignment	122
About crossover	123
About ECLIPSE Web Services sound effect customizations	124
Adjusting sound quality	125
Displaying the sound adjustment screen	125
Adjusting PEQ (Parametric equalizer)	127
Adjusting/Saving a PEQ	128
Selecting a PEQ pattern from memory	130
Measuring/Displaying frequency characteristics	130
To avoid writing measurement results to the “Memory Stick Duo”	130

To write measurement results to a “Memory Stick Duo”	131
Adjusting POS (Positioning selector)	132
Setting the balance	133
Setting LOUDNESS	134
Setting the harmonizer	134
Setting/Adjusting the surround system	135
Setting the Dolby Pro Logic II	135
Setting the CENTER LEVEL	136
Setting the REAR LEVEL	136
Setting the CENTER WIDTH	137
Setting the COMPRESSION	138
Setting/Adjusting the speakers	139
Setting the speaker system	139
Adjusting time alignment	140
Manual adjustment	140
Automatic adjustment	142
Adjusting crossover	143
Adjusting sub-woofer output level	145
Setting phase control	146
Adjusting speaker levels	147
Adjusting speaker size	148
Importing sound data	150
Display settings	151
Screen settings when the optional 5.1 ch decoder/AV matrix unit is connected	151
External monitor image settings	151
How to use AUX	152
Listening to AUX	152
Switching to AUX using the touch switches	152
Switching to AUX using the panel buttons	152
Switching the AUX input	153

For reference

Important Points	154
If one of these messages appears	154
Before asking for repairs.	156
Other	158
Products equipped with Dolby Digital	158
Products equipped with Macrovision	158
Glossary	159
Topic index	161
About screen and sound adjustment.	161
About using AM/FM radio	162
About using the CD player and CD changer	162
About using the MP3/WMA player	163
About using the Memory Stick player	163
About using the DVD player	164
About using optional 5.1 ch decoder/AV matrix unit	165
When something isn't clear.	166
Index	167

MEMO



1. How to use this manual

Item title

A number and title is assigned to each item.

Section title

A title is assigned to each section.

Operation title

A title is assigned to each operation.

Operation procedure

Describes the operation. Proceed with the operation steps in numerical order.

Attention

Additional points regarding operation are given here.

Basic operation

Adjusting sound quality

Setting LOUDNESS

Audio can be modulated to correct for insufficient bass and treble when listening at low volume.

- 1 Touch **ON** , or **OFF** for **LOUDNESS**.
 - The selected touch switch will turn light blue.
- 2 Touch **BACK** .



The screenshot shows the 'SOUND SETTING' menu with 'LOUDNESS' set to 'ON' and 'HARMONIZER' set to 'LOW'. Other options include 'EQ', 'POS', and 'SETTING'.

Setting time alignment

This function corrects the position characteristics and frequency characteristics in order to delay the signals being output from the various speakers, causing the signals from each delay reach the listening position at the same time.

- 1 Touch **SETTING** .
 - The setting screen will appear.



The screenshot shows the 'SOUND SETTING' menu with 'LOUDNESS' set to 'ON' and 'HARMONIZER' set to 'LOW'. Other options include 'EQ', 'POS', and 'SETTING'.

Attention You can set time alignment at the same time as adjusting position selector and balance.

36

Detailed operation title

A title is assigned to each detailed operation.

Selecting the type of vehicle (CAR TYPE)

You can select the time alignment settings to match your vehicle from a range of preset settings for different types of vehicle, allowing you to select the optimum time alignment settings automatically.

- 1 Touch **COMPACT**, **SEDAN**, **WAGON**, **MINI VAN**, **SUV** or **SMALL** for CAR TYPE.

- Touch **BACK** after making settings. The time alignment setting will be saved and the system will return to the previous screen.



Setting the tweeter (TWEETER)

You can select the tweeter installation location and whether or not a tweeter is being used or not, allowing you to select the optimum time alignment settings automatically.

- 1 Touch **NONE**, **DASH** or **DOOR** for TWEETER.

- Touch **BACK** after making settings. The time alignment setting will be saved and the system will return to the previous screen.



Back operation

Section side heading

The side heading for the current section.

Operation screen

A screen showing the operation.



If the front speakers have been installed to the dash panel, you can set the tweeter setting to "DASH" even if no tweeter has been installed.

37

Continue to the next page

Indicates that operation procedures continue on the next page.

2. Features

DVD player with sharp video and dynamic sound (Page 92)

Plays DVD videos recorded with high image and sound quality.

(DVD media is able to record a movie with high quality video and digital sound that exceeds the quality of CD media.)



MP3/WMA player that plays back the equivalent of several albums of music recorded on a single music disc (Page 72)

MP3 audio compression technology compresses audio data to one-tenth of its original size. CD-R/RW discs with recorded MP3/WMA files can be played.



Memory Stick player for playing music downloaded from a computer (Page 84)

Supports ATRAC3 audio compression technology which combines high sound quality with a high compression rate. Audio files downloaded to the MG Memory Stick Duo from computers or mobile phones can be played.



Selection and display of preferred wallpaper (screen backgrounds) (Page 39)

Wallpaper of your choice can be selected and displayed for use as the background of the information screen and audio operation screens.

A screen from the navigation unit can also be linked to and selected.



- Setting wallpaper for the information screen and audio operation screens

System upgrades

● CD changer (Page 88)

A CD changer enables non-stop playing of multiple discs, for convenience at times such as taking a long drive.

It is easy to search for and play a song from among the discs on a changer.



● VTR (Page 116)

Videos can be watched if a VTR deck is connected.

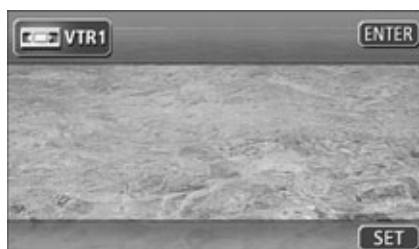

● 5.1 ch decoder/AV matrix unit (Page 119)

Dolby Digital (5.1 ch), DTS (5.1 ch), and Dolby Pro Logic are supported when the 5.1 ch decoder/AV matrix unit is connected.

These technologies allow the listener to enjoy theater-quality sound within the vehicle's interior. This unit also allows for finer audio adjustments and the connection of up to two external monitors.



3. Before using the deck

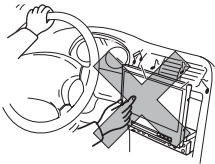

- Be very careful and pay close attention to safety when operating the audio controls while driving, otherwise accidents may occur. Also be sure to set the volume so that you can still adequately hear sounds outside the vehicle.
Otherwise damage may occur.

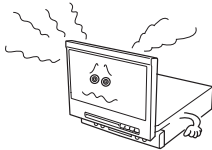

- Never continue to use the system if it is malfunctioning in any way. If you notice smoke, abnormal noises or abnormal odors, turn off the power immediately. Immediately turn off the audio in such situations.

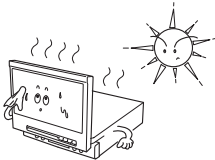

- Exercise caution as to the temperature inside the vehicle. The temperature inside the vehicle can increase during hot weather. Wait for the temperature inside the vehicle to drop before using the unit.
Otherwise damage may occur.

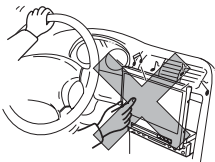

- Drivers should not operate the DVD player while driving. Also be sure to set the volume so that you can still adequately hear sounds outside the vehicle.
Otherwise damage may occur.

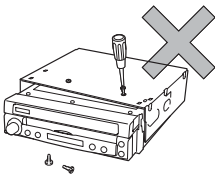

- Do not disassemble or modify the deck. The deck has a precisely designed structure, so contact the store of purchase in the event of any unsatisfactory performance.

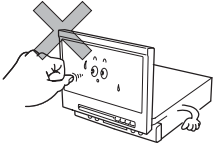

- Do not apply excessive force to the monitor, or damage may occur.

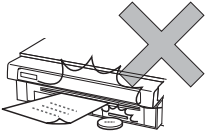

- Do not insert any objects other than discs or Memory Sticks into the slot. Otherwise damage may occur.

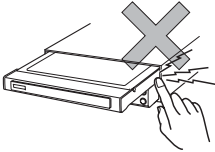

- Be careful not to get fingers or other objects caught in the monitor when it is being retracted into place. Interference can cause injury or damage the deck.

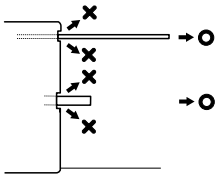

- When removing a disc or Memory Stick from the deck, be sure to pull it out horizontally. Do not pull discs or Memory Sticks up forcibly or press down on them strongly while removing them. Improper removal can scratch discs, cause deck noise or damage Memory Sticks.

Before using the deck

About discs



- Water droplets (condensation) can form on the inside of the unit during cold or rainy weather in the same way car windows can fog up. When this happens, the audio can jump and playback can stop, so ventilate or dehumidify the vehicle for a short time before operating the equipment.
- To safeguard the components of the player, the unit will automatically stop when a malfunction occurs. If the player will not operate even when the messages displayed on the screen are followed, it is possible that the unit has been damaged. Contact the store of purchase.
- It is possible that the sound will skip if the vehicle experiences violent motion on rough roads.

About supported disc types

- An audio or DVD video disc bearing one of the marks shown below can be played.
- Depending on the type of disc used, playback may not be possible.



- Supports Dolby Digital. Discs bearing the following mark can be used.



Manufactured under license from Dolby Laboratories, Inc. Dolby and the double-D symbol are registered trademarks of Dolby Laboratories.

- Supports DTS 2.0 + Digital Out. Discs bearing the following mark can be used.



"DTS" and "DTS 2.0 + Digital Out" are trademarks of Digital Theater Systems, inc

- It is possible that a CD-R (CD-Recordable) or CD-RW (CD-ReWritable) disc will not play on the unit due to special disc characteristics, scratches, dirt or deterioration caused by long storage in the vehicle. In addition, an unfinalized CD-R or CD-RW disc written in CD-R, CD-RW or UDF format will not play on the unit.
- It is possible that a DVD-R/RW (DVD-Recordable/ReWritable) or DVD+R/RW (DVD+Recordable/ReWritable) disc will not play on the unit due to special disc characteristics, scratches, or dirt or deterioration caused by long storage in the vehicle. In addition, an unfinalized DVD-R or DVD-RW disc will not play on the unit. It is possible that discs recorded using a computer may not play on the unit depending on the environment and/or settings of applications used to record them.
- The CD-TEXT function requires commercially available CDs which support CD-TEXT. It is possible that characters in CD-R and CD-RW data may not be displayed correctly.



- Super Audio CDs can only be played in the hybrid disc layer.
- CCCDs (Copy Control CD) do not conform to official CD standards and so are not supported.
- CD-EXTRA discs can be played as audio CDs.
- Voice tracks on Mixed Mode CDs cannot be played. Only music tracks will be played.
- Video-CDs cannot be played.



About handling discs

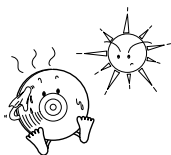

- Be sure to store discs in their cases and keep them out of direct sunlight. Discs can warp and become unusable.

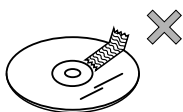

- Do not apply paper-based tape to either the recording side or label side of a disc. Otherwise damage may occur.



- Do not use discs that are warped or cracked. Otherwise damage may occur.



- Do not touch the recorded side of a disc (iridescent side of the CD) when handling it. The disc may become dirty, causing jumping to occur.



- Using a disc that is dirty can scratch the disc and result in sound jumping. Use a commercially available compact disc cleaner to clean the CD, wiping lightly from the center to the edge.

Before using the deck



About new discs

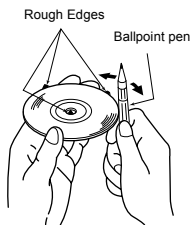

- You may notice that some brand new discs are rough around the center hole or outside edge. Remove the rough edges with the side of a ballpoint pen, etc. before using. Rough edges may prevent proper loading in the unit. Flakes from the rough edges may also stick to the recorded surface and interfere with playback.

About rental discs

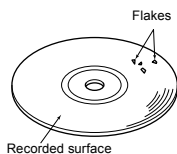

- Do not use CD discs with attached cellophane tape, rental CD discs with glue protruding from labels or discs with the residue of peeled adhesives. These discs can prevent the player from properly opening and closing as well as cause other damage.

About specially shaped discs

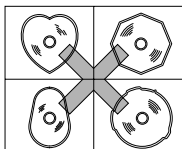

- Specially-shaped CDs cannot be played. Do not attempt to play them, even with an adapter, since they may damage the player.
- Do not use commercially available lens cleaners, as they may cause damage to the pickup of the player.

About disc accessories

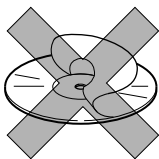

- Do not use accessories such as stabilizers, protective seals, or laser lens cleaners sold for "improving sound performance" or "protecting CDs." Changes in CD thickness or outside dimensions made by these accessories may cause problems in the player.

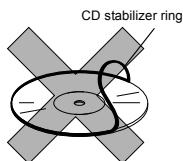

- Do not attach any ring-shape protector (or other accessory) to your discs. These protectors are commercially available and said to protect discs and to improve sound quality (and add an anti-vibration effect), but they can do more harm than good during regular use. The most common problems are insert/eject related problems and "No playback" problems due to the protector ring coming off in the disc mechanism.

About the Memory Stick Duo



- Do not leave the Memory Stick Duo in a place where it can be exposed to static electricity or electrical noise. Otherwise, data may be lost.
- To safeguard the components of the player, the unit will automatically stop when a malfunction occurs. If the player will not operate even when the messages displayed on the screen are followed, it is possible that the unit has been damaged. Contact the store of purchase.
- After playback or uploading of data to the hard drive is complete, promptly remove the MG Memory Stick Duo.
- Do not remove the Memory Stick Duo while it is being used to playback data or upload data to the hard drive. Otherwise, data may be lost. Please be aware that we will not be held responsible for lost data.

About supported Memory Stick Duo types

- Memory Stick Duos with a capacity of up to 128MB are supported.
- The Memory Stick PRO Duo is not supported.
- MG Memory Stick Duos labeled with the following marks can be used with this device.

MAGICGATE

- MG Memory Stick Duos labeled with the following marks can only be used when registering a pass code in database update or Eclipse Security Network (ESN).



MagicGate Memory Stick **MAGICGATE** and Memory Stick  are registered trademarks of Sony Corporation.

- Use a dedicated device to format (initialize) the MG Memory Stick Duo. The Memory Stick Duo cannot be used on this unit if it has been formatted using a device other than a dedicated device.

Before using the deck



About handling the Memory Stick Duo

- In order to maintain a high quality sound, regularly wipe clean any dust or dirt from the surface of the cartridge with a dry cloth.
- Do not use Memory Stick Duos with tape or peeling labels.
- Store in a dry place, out of direct sunlight. Otherwise, it may become impossible to use the Memory Stick.

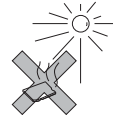

- Always place in the case provided when transporting or storing.
- Do not touch terminals with metal objects or your bare hands.

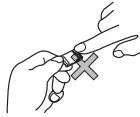

About the LCD panel



- The LCD panel can appear to be white or black when seen from certain angles.
- The screen will be difficult to see when external light such as sunlight falls on the display.

MEMO

1. Switching modes

The unit can be used when the vehicle's ignition switch is in the ON or ACC position.

Switching the mode

Switching the source when the display is retracted

1 Press **VOL** .

2 Turn **VOL** to select the audio source.

- When the VOL button is turned, the source will be changed in the order shown below.



*: Optional

- If no disc is inserted or no device is connected to a source, it will not be possible to switch to that source.

3 Press **VOL** .

Switching the source when the display is raised

1 Press **VOL** .

- The SOURCE MENU screen is displayed.

2 Touch the touch switch for an audio source and relevant mode will be displayed on the screen.



Displaying operation screen

1 Press **AUDIO** .



2 Touch the SOURCE MENU RECALL switch (indicated at left) in the audio or DVD/VTR operation screen.

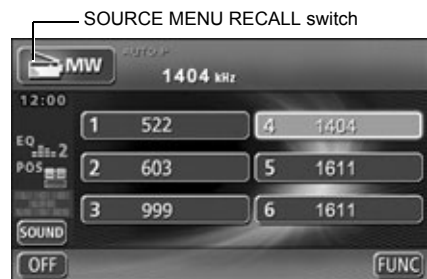

3 When the SOURCE MENU switch is touched, the operation screen for the selected source is displayed.

- Touch  to return to the original screen.



2. Operation screen of each mode

The operation screen for each mode will appear as shown below.

- AM radio operation screen



- FM radio operation screen



- CD player operation screen



- MP3/WMA player operation screen



- Memory Stick player operation screen



- DVD player operation screen



- CD changer operation screen (optional)



- VTR operation screen

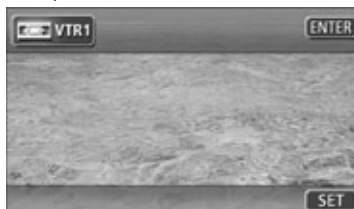

- AUX operation screen (optional)



When the operation screen for the DVD or VTR has not been operated for 6 seconds or more, it will automatically be canceled.

3. Adjusting the volume

Adjusting the main volume

- 1 Turn the **VOL** button.
 - Adjustment levels from 0 to 80 are available.
 - Turn to the right : Volume UP (louder)
 - Turn to the left : Volume DOWN (quieter)

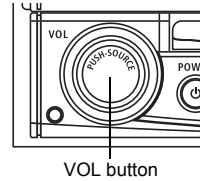

Setting the BEEP tone

The guide tone that is emitted when touching a panel switch or touch switch can be set.

- 1 Press **NAVI MENU** .
- 2 Touch **INFO.** .
- 3 Touch **SETTING** in the INFORMATION screen.
- 4 Touch **1** , **2** , **3** , **4** , or **OFF** for GUIDE TONE.
 - The selected touch switch will turn light blue.
 - Touch **OFF** to cancel (turn off) the guide tone.
- 5 Touch **ENTER** .



- Set the volume at a level which will not adversely affect your safety while driving.
- The volume level may change after switching sources. Adjust the volume to match the source being used.
- If the volume is adjusting during DVD playback, this adjusted volume can be saved as the volume level for the DVD player.
- A volume adjustment made during DVD playback will not affect other sources. The volume will return to the level set for the source used prior to the DVD.

4. Adjusting sound quality

By adjusting the equalizer and the volume balance you can simulate a favored sound environment within the vehicle.

Sound quality can be adjusted in all audio operation screens.

Displaying the sound adjustment screen

- 1 Touch **SOUND** .
 - Touch **SET** in the VTR operation screen, or **NEXT** in the DVD operation screen followed by **SET** to display the **SOUND** switch.



● The sound adjustment screen can be changed to the following adjustment screens.

● Sound adjustment screen



EQ

● Parametric equalizer adjustment screen



POS

● Position setting screen



SETTING

● Time alignment adjustment screen



Adjusting sound quality

The following settings/adjustments can be made in operation screens and setting screens.

Touch switch/item	Function	Page
PEQ	The median frequency, frequency level, and Q curve pattern can be adjusted using the 7-band parametric equalizer.	31
POS	Sound localization can be adjusted according to the number and position of passengers in order to obtain optimum acoustic effects.	34
FADER BALANCE	The left/right/front/rear balance can be adjusted.	35
LOUDNESS	It is possible to emphasize bass/treble when listening at low volume.	36
HARMONIZER	It is possible to set the harmonizer level so that compressed data is played back with a sound quality corrected to a level as close as possible to that of the original data.	38

Adjusting EQ (equalizer)

Adjusts sound quality to preferred characteristics according to the music genre and audio source.

Adjusting/saving EQ

The sound quality can be adjusted according to music genre and then stored. This product has a 7-band parametric equalizer which can adjust median frequency, frequency level, and Q curve (bandwidth).

1 Touch the frequency of each band to select the frequency (median frequency) you want to adjust.

- Each time the switch of each band is touched, the median frequency will be switched in the order shown below.

Band	Median frequency (Hz)
1	63 → 80 → 100
2	125 → 160 → 200
3	250 → 315 → 400 → 500
4	630 → 800 → 1k → 1.25k
5	1.6k → 2k → 2.5k → 3.15k
6	4k → 5k → 6.3k → 8k
7	10k → 12.5k → 16k

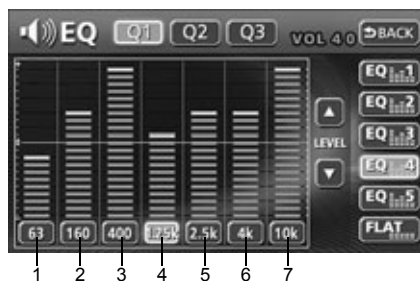

2 Touch the desired frequency height level.

- To make fine adjustments, touch ▲ or ▼.



Adjusting sound quality

3 Touch **Q1**, **Q2**, or **Q3** to select a Q curve.

- The Q curve patterns set the median frequency bandwidth as follows:

Switch	Q curve pattern
Q1	Mild (bandwidth: wide)
Q2	Mid (bandwidth: medium)
Q3	Sharp (bandwidth: narrow)



4 Repeat steps 1 through 3 to change the setting for each band.

- It is not possible to set more than one band in the same channel to the same median frequency.

5 Touch the switch you want to use to save (**EQ1** to **EQ5**) until you hear a beep.

- Save the PEQ settings for future use.
- Touch **BACK** after making settings.

The PEQ mode adjustment will be saved and the system will return to the previous operation screen.



ATTENTION

- If you touch and hold **▲** or **▼** during fine adjustment, the frequency level will continue to adjust automatically until it reaches the center value (0). Touch **▲** or **▼** again to continue adjustment.
- Touch **FLAT** to return to the center value (0).

Selecting a PEQ pattern from memory

1 Touch a switch from **EQ1** to **EQ5** .

- The preset pattern stored in memory will be retrieved.
- Touch **BACK** after making settings. The PEQ mode adjustments will be saved and the system will return to the previous operation screen.

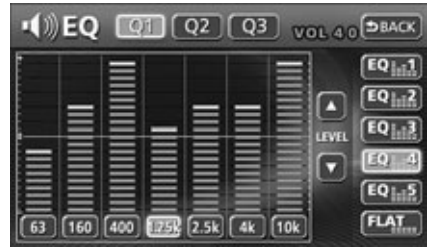

Resetting EQ curves

The currently saved equalizer can be returned to the default values.

1 Touch **FLAT** until you hear a beep.

- The equalizer curve will be reset to the default values.

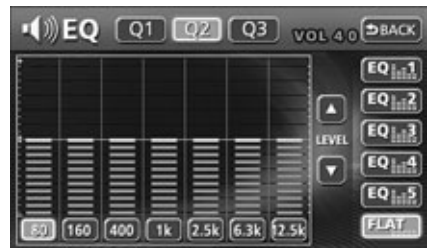

Adjusting sound quality

Adjusting POS (Positioning selector)

Sound localization can be adjusted according to the number and position of passengers in order to obtain optimum acoustic effects.

A seat's sound localization can be adjusted simply by touching a switch.

1 Touch one of the seat images displayed in the POSITION setting screen to switch the sound localization for that seat.

- The selected position will be indicated in a yellow box. Touch the seat again to cancel the selection. The four positions shown in the table below can be set.
- Touch **OFF** to cancel all settings.
- Touch **←BACK** after making settings. The position will be saved and the system will return to the previous operation screen.



Touch switch	Function	Touch switch	Function
	Acoustics optimized for left side seat		Acoustics optimized for both front seats
	Acoustics optimized for right side seat		Acoustics optimized for rear seats



- You cannot set POS (Positioning selector) at the same time as adjusting the balance (next page) or time alignment.
- This product is configured for vehicles with left-hand drive.

Setting the balance

The left/right/front/rear balance can be adjusted so that sound from all speakers arrives at the listener's ears at the same time.

- 1 Touch **FADER BALANCE** in the POSITION setting screen to display the volume balance adjustment screen.



- 2 Touch the screen at the preferred balance point.

- To make fine adjustments, touch **▲**, **▼**, **◀**, or **▶**.
- Touch **CENTER** to set the volume balance to the center position.
- Touch **↶BACK** after making settings. The set volume balance will be saved and the system will return to the previous operation screen.
- To set the position again, touch **POS** and repeat the steps above.



- You cannot set the balance at the same time as adjusting POS (Positioning selector) (previous page).
- Touch and hold **▲**, **▼**, **◀** or **▶** while making fine adjustments to adjust values continuously. Adjustment will lock when it reaches the center value, and **▲**, **▼**, **◀** or **▶** must be touched again to continue adjustment.

Adjusting sound quality

Setting LOUDNESS

Audio can be modulated to correct for insufficient bass and treble when listening at low volume.

1 Touch **ON**, or **OFF** for LOUDNESS.

- The selected touch switch will turn light blue.

2 Touch **BACK**.



Setting time alignment

This function corrects the position characteristics and frequency characteristics in order to delay the signals being output from the various speakers, causing the signals from each speaker reach the listening position at the same time.

1 Touch **SETTING**.

- The setting screen will appear.



You can set time alignment at the same time as adjusting position selector and balance.

Selecting the type of vehicle (CAR TYPE)

You can select the time alignment settings to match your vehicle from a range of preset settings for different types of vehicle, allowing you to select the optimum time alignment settings automatically.

- 1 Touch **COMPACT**, **SEDAN**, **WAGON**, **MINI VAN**, **SUV** or **SMALL** for CAR TYPE.

- Touch **BACK** after making settings. The time alignment setting will be saved and the system will return to the previous screen.



Setting the tweeter (TWEETER)

You can select the tweeter installation location and whether or not a tweeter is being used or not, allowing you to select the optimum time alignment settings automatically.

- 1 Touch **NONE**, **DASH** or **DOOR** for TWEETER.

- Touch **BACK** after making settings. The time alignment setting will be saved and the system will return to the previous screen.



ATTENTION

If the front speakers have been installed to the dash panel, you can set the tweeter setting to "DASH" even if no tweeter has been installed.

Adjusting sound quality

Selecting rear speaker position (REAR SPEAKER)

You can select the rear speaker installation location, allowing you to select the optimum time alignment settings automatically.

- 1 Touch **DOOR** or **OTHER** for REAR SPEAKER.
 - Touch **←BACK** after making settings. The time alignment setting will be saved and the system will return to the previous screen.



Setting the harmonizer

It is possible to set the sound quality boost level to automatically regenerate harmonics such as reverberation, depth, and tone lost in compression, producing a much clearer sound.

- 1 Touch **LOW** or **HI** for HARMONIZER.
 - **LOW** : Low level of correction
 - **HI** : High level of correction
 - **OFF** : No correction

- 2 Touch **←BACK** .



5. Setting the background screen

The background for the audio operation screen, information screen and navigation screen can be changed to a preferred wallpaper.

Setting the Pic-CLIP

- 1 Press **NAVI MENU** .
- 2 Touch **INFO.** in the MENU screen.
- 3 Touch **SETTING** .
- 4 Touch **CHANGE** for Pic CLIP.
- 5 Touch **1** , **2** , **3** , **4** or **5** for PICTURE or MOTION PICTURE.
- 6 Touch **ENTER** .



Setting the background screen

Uploading the image data from another source

Image data (still pictures) recorded in the HDD of the device, or on a CD-R/RW or "MG Memory Stick Duo", can be displayed as a Pic-CLIP.

- 1 Press **NAVI MENU** .
- 2 Touch **INFO.** in the MENU screen.
- 3 Touch **SETTING** .
- 4 Touch **CHANGE** for Pic-CLIP.
- 5 Touch **CHANGE** for PICTURE.



- 6 Touch **MEMORY STICK** , **CD** , or **HDD** to select the location of the image data.
- 7 Touch the image data to be set for Pic-CLIP.
- 8 Touch **ENTER** .
 - Touch **PREVIEW** to display the selected image.
- 9 Touch **BACK** .
- 10 Touch **CUSTOM** .
 - The set Pic-CLIP will be displayed.
- 11 Touch **ENTER** .



Caution

- If any data other than image data are located on the same disc, image data cannot be read out.
- When image data are to be uploaded from the HDD (hard disk) of the device, save the image data to the HDD in advance. (Refer to the section "Saving image data" on page 44.)
- When image data are to be uploaded from a CD-R/RW, insert the CD-R/RW containing the image data into the disc slot.
- When image data are to be uploaded from a "Memory Stick Duo", insert the "Memory Stick Duo" containing the image data into the "Memory Stick" slot.
- If there are five image files or more, touch ▲ or ▼ to switch the list to be displayed.

Setting the background screen

Image data storage

Wallpaper image data must be stored in one of the following ways.

- Image data written to a "Memory Stick Duo" from a digital camera
- Image data written to a CD-R/RW from a PC or similar device
- Image data written to a "Memory Stick Duo" from a PC or similar device

The following restrictions apply when storing image data.

■When writing to CD-R/RW from a PC or similar device

	CD-R/RW
Disc format	ISO 9660 Standard (MODE1)
Image capacity	1.5 MB or less (per file)
Image size	Approx. 4.01 million pixels or less
File extension	.jpg (no support for JPEG2000)
Writing system	Single session only
Number of files displayed	Up to 100
Number of characters of file name	Up to 8 characters (+.jpg) (ISO 9660 LEVEL1 system)
Number of characters displayed	Up to 8 characters (+.jpg) ^{*1/*2}
Image files to be recorded	Root directory only (Top layer only)

*1 Numbers, letters (capitals), and "_" (underscore) only.

*2 The extension ".jpg" will not appear.

■When writing to a "Memory Stick Duo" from a PC or digital camera

When writing to a "Memory Stick Duo" from a PC or digital camera, it is recommended that you use a dedicated device to format your "Memory Stick Duo".

	"Memory Stick Duo"
Disc format	-
Image capacity	1.5 MB or less (per file)
Image size	Approx. 4.01 million pixels or less
File extension	.jpg (no support for JPEG2000)
Writing system	-
Number of files displayed	Up to 100 ^{*1}
Number of characters in file name	Up to 8 characters (+.jpg) ^{*2}
Number of characters displayed	Up to 19 characters ^{*2/*3} (8 characters for file name + 11 characters for folder name)

"Memory Stick Duo"	
Contents of list display (in order of display)	<ul style="list-style-type: none"> •Files in PIC folder ① : PIC/5 *³ ② : PIC/6 *³ •Digital camera files ③ : D/Automatically created folder name/3 *³ ④ : D/Automatically created folder name/4 *³ ⑤ : DCIM/6 *³ •Files in root ⑥ : ROOT/1 *³
Image files to be recorded	<p style="text-align: right; font-size: small;">The folder or file to be automatically created when a digital camera is used</p>

- *1 If a "Memory Stick Duo" contains image data from both a digital camera and a PC, a total of up to 100 files can be displayed.
- *2 Numbers, letters (capitals), and "_" (underscore) only
- *3 The extension ".jpg" will not appear.
- *4 The folder is automatically created when a digital camera is used.
- *5 When you save data to a "Memory Stick Duo" from a PC, create the "MSFTEN" and "PIC" folders, then save the data in the PIC folder.



- If the image size is larger than 400 (W) x 234 (H) pixels, the original image will be reduced to the specified size and displayed. Any areas without image data will be displayed as solid black.
- If the image size is smaller than 400 (W) x 234 (H) pixels, both width and height are centered (displayed in the center), and any area without image data will be displayed as solid black.

Setting the background screen

Saving image data

Up to 100 files of image data recorded on a CD-R/RW, "MG Memory Stick Duo" or "Memory Stick Duo" can be uploaded to the HDD (hard disk) of the device.

1 Press **NAVI MENU** .

2 Touch **INFO.** in the MENU screen.

3 Touch **DATA** .

4 Touch **SAVE (HDD)** for Pic-CLIP DATA.



5 Touch **MEMORY STICK** or **CD** to select the location of the image file.

6 Touch the image data to be saved.

7 Touch **SAVE**.

- Touch **ALL SAVE** to save all the image files recorded on the "Memory Stick Duo" or CD.

- Touch **PREVIEW** to display the selected image. Touch **BACK** to return to the original screen.



- If any data other than image data are located on the same disc, image data cannot be read out.
- When image data are to be uploaded from a CD-R/RW, insert the CD-R/RW containing the image data into the disc slot.
- When image data are to be uploaded from a "Memory Stick Duo", insert the "Memory Stick Duo" containing the image data into the "Memory Stick" slot.
- If there are five image files or more, touch ▲ or ▼ to switch the list to be displayed.

Setting the background screen



- The following screen will appear if the same file name already exists.



- Touch **OVERWRITE** to overwrite the old data with the new data.
- Touch **AUTO-ASSIGN** to save the file with a specified number prefixed to the file name.
 [Example] If "AA1.jpg" already exists, the new file with the same file name is automatically renamed to "001_AA1.jpg" and saved.
- Touch **ALL SAVE**, and then touch **CANCEL** to cancel saving the image file in progress and start saving the next image file.
- If the capacity of HDD is insufficient, the following screen will appear.



- Touch **CREATE SPACE** to delete a part of the saved data.
- Touch **CANCEL** to stop saving.

Deleting image data

Deletes image data from the HDD (hard disk) of the device.

- 1 Press **NAVI MENU** .
- 2 Touch **INFO.** in the MENU screen.
- 3 Touch **DATA** .
- 4 Touch **DELETE (HDD)** for Pic-CLIP DATA.
- 5 Touch the image file to be deleted.
- 6 Touch **DELETE** .
 - Touch **ALL DELETE** to delete all the files saved on the HDD.
- 7 Touch **YES** .



Setting the background screen

Setting opening screen

A preferred wallpaper can be set to display as the opening screen. This is the screen that is displayed when power to the device is turned ON.

Setting the opening screen

1 Press **NAVI MENU** .

2 Touch **INFO.** .

3 Touch **SETTING** .

4 Touch **NEXT** .

5 Touch **CHANGE** for OPENING.



6 Touch **1** , **2** or **3** .

- The selected screen is displayed.

7 Touch **ENTER** .



6. Adjusting/setting the screen

Switching the FUNCTION switch display

Touch switches not frequently used are not displayed in the audio operation screens and DVD screens. These switches can be displayed as follows.

1 Touch **FUNC** .

- The FUNCTION switches appear.
- The FUNCTION switches are different in each audio mode.



- The FUNCTION switches can be hidden by touching .
- If the FUNCTION switches are displayed, operations corresponding to other switches cannot be performed. Hide the FUNCTION switches, then try the operation again.



Quality adjustments can be made for images such as the audio operation screen, navigation screen, and DVD (optional) or VTR (optional).

Displaying the image adjustment screen

Contrast, brightness and other picture settings can be adjusted to match viewing preferences for DVD video or the audio operation screen.

To make viewing easier, the display switches between daytime display and nighttime display depending on whether the vehicle lights (parking lights, taillights, license plate lights) are on or off.

(Default settings)

- Vehicle lights are on . . <Nighttime display>
- Vehicle lights are off . . <Daytime display>

[Audio operation screen]



● Daytime display [Vehicle lights are off]



● Nighttime display [Vehicle lights are on]

[DVD/VTR Screen]



● Daytime display [Vehicle lights are off]



● Nighttime display [Vehicle lights are on]

Adjusting/setting the screen

- 1 Press **DISP** briefly (for less than 1 second) on the audio mode operation screen or DVD/VTR screen.
- 2 Touch **ENTER** after making any adjustments.
 - If no operations are made for about 20 seconds, the display will return to the previous screen.



- When adjusting from the audio operation screen or navigation screen



- When adjusting from the DVD/VTR screen

Setting daytime display to display when vehicle lights are on

- 1 The screen will be switched between daytime display and nighttime display each time **DAY** is touched.



- When adjusting from the audio operation screen or navigation screen



- When adjusting from the DVD/VTR screen

Turning the screen off

- 1 Touch **OFF**.
 - Press **AUDIO** or **NAVI** to turn the screen back on.

Adjusting image quality

The daytime display and nighttime display can be separately adjusted.



● When adjusting from the audio operation screen or navigation screen



● When adjusting from the DVD/VTR screen

■ CONTRAST

1 Touch **+** to increase contrast, or **-** to decrease contrast.

■ BRIGHT

1 Touch **+** to increase brightness, or **-** to decrease brightness.

■ COLOR (for DVD/VTR screen only)

1 Touch **+** to increase green, or **-** to increase red.

■ TINT (for DVD/VTR screen only)

1 Touch **+** for a darker tint, or **-** for a lighter tint.

Switching screen mode

1 Touch **WIDE** .

● DVD : Touch **NEXT** followed by **SET** in the operation screen.

VTR : Touch **SET** in the operation screen.

2 Touch **NORMAL** , **WIDE1** , **WIDE2** or **WIDE3** .

● This selects the display mode.



Adjusting/setting the screen

3 Touch **↶BACK** .

- Returns to the DVD or VTR operation screen.



■ NORMAL mode

The screen is shown with a vertical to horizontal ratio of 3 to 4. The side edges are black.



■ WIDE 1 mode

The screen is shown with a vertical to horizontal ratio of 3 to 4 and is expanded in the left and right directions. A wide screen effect can be displayed without any image loss.



■ WIDE 2 mode

Only the left and right edges of the screen are stretched out. However, the vertical to horizontal ratio of 3 to 4 is maintained at the center of the screen to provide a comfortable wide screen image.



■ WIDE 3 mode

The screen is expanded in both the vertical and horizontal directions by the same ratio. The image is clipped slightly at the top and bottom edges.



Viewing images with a wide screen privately poses no problem legally. However, if the images are compressed or expanded for public or commercial viewing purposes, this action may infringe upon the rights of the creators of those images which are protected by applicable copyright laws. Please exercise caution.

7. Setting the control panel

Switching the sub display

The display contents of the sub display can be switched between the audio source display and the clock display.

- 1 Press **DISP** until you hear a beep.
 - Each time the button is pressed, the audio source display and clock display are switched.

Switching the control panel illumination

The control panel illumination color can be switched between blue and red.

- 1 Press **NAVI MENU** .
- 2 Touch **INFO.** in the MENU screen.
- 3 Touch **SETTING** .
- 4 Touch **BLUE** or **RED** for ILLUMINATION.
- 5 Touch **ENTER** .



1. How to use the AM/FM radio

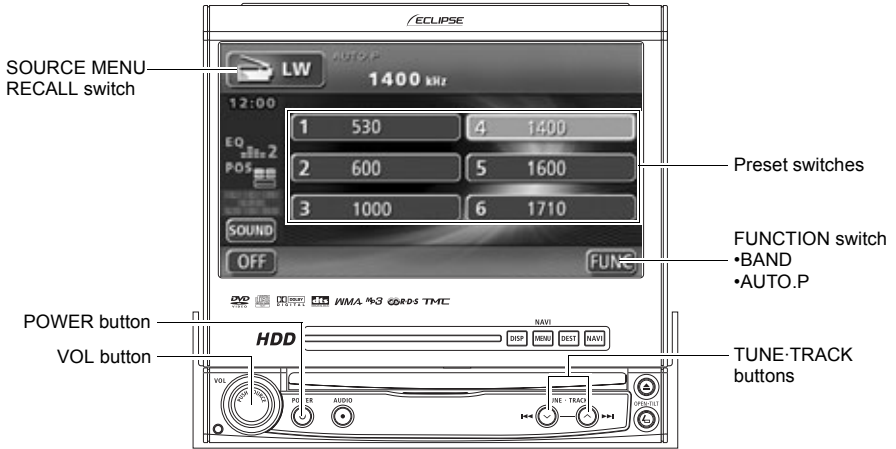

Listening to the AM/FM radio

Listening to the radio when the display is raised





- 1 Press **VOL** or touch the SOURCE MENU RECALL switch.
- 2 Touch **AM** for AM radio, or **FM** for FM radio.

Listening to the radio when the display is retracted



- 1 Press **VOL** .
- 2 Turn **VOL** to select AM or FM.
- 3 Press **VOL** .

Selecting radio stations

Manual selection

- 1 Press  or  .
 - Pressing the switch once moves the frequency one step up or down. (One step on the LW band is 3kHz. MW band is 9kHz. One step on the FM band is 0.05MHz)
 -  (up) : Raises the frequency
 -  (down) : Lowers the frequency

Automatic selection

- 1 Press and hold  or  until you hear a beep.
 - The station that is closest to the current frequency will be searched for automatically, and searching will stop when the station is received. To stop the search before a station is found, press the button again.

Selection using preset switches

- 1 Touch a preset switch that already has a station recorded.
 - Refer to "**Saving radio stations**" on page 59 for details on saving radio stations.



If the reception for a particular station is weak in the area you are in, the automatic selection may not work.

How to use the AM/FM radio

Selecting radio bands

1 Touch **FUNC** .



2 Touch **BAND** .

- Each time the switch is touched, the radio band will be changed in the order shown below.

FM: FM1 ↔ FM2

AM: LW ↔ MW



Saving radio stations

There are two modes for saving radio stations, manual and AUTO. P. These modes operate independently.

Saving manually

Make sure "AUTO. P" is not displayed in the upper part of the screen.

- If "AUTO.P" is displayed, display the FUNCTION switches and touch **AUTO.P** to switch to manual mode.

1 Use manual tuning or automatic tuning to select the station to be saved.

2 Choose a preset switch and touch it until you hear a beep.

- The radio station (frequency) is set. Touch the preset switch to tune in the selected station.

Saving with AUTO.P

1 Touch **FUNC** .

2 Touch **AUTO.P** until you hear a beep.

- The AUTO.P function will activate and start automatically selecting stations. You will hear a beep when the automatic selection of stations is completed. Touch **AUTO.P** again to return to the broadcast stations originally saved.

Changing stations saved by AUTO.P

1 Use manual tuning or automatic tuning to select the station to be saved.

2 Touch the preferred preset switch until you hear a beep.

How to use the AM/FM radio

About AUTO.P

Because the AUTO. P function can be used to temporarily save stations for the preset switches, stations saved manually will remain in memory even if AUTO. P is used. Manually saving stations that are used regularly allows them to be restored even after AUTO. P has been used, such as after traveling.

Touching **AUTO.P** while AUTO.P is operating or after it has been used will return the preset memories to their previous settings. (The stations saved with AUTO. P will be deleted.) The diagram below shows how to switch between AUTO. P and manual.

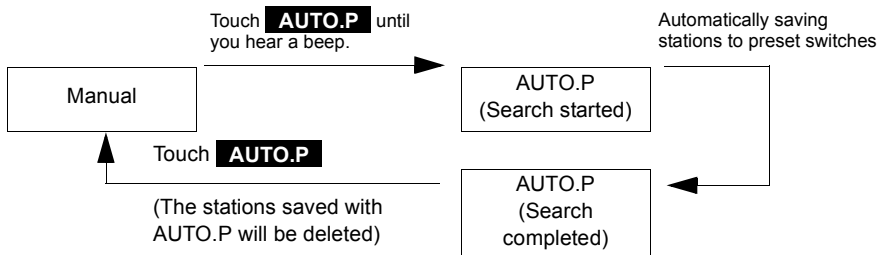

- AUTO. P may not automatically receive stations if radio waves in the surrounding area are weak.
- A frequency saved with the tuning switch may not match the frequency saved with AUTO. P even though the signal is received from the same station.
- Due to conditions for receiving radio waves, saved stations may differ even when the AUTO. P switch is operated repeatedly in the same location.
- Up to six stations with good signal reception are automatically saved in order of frequency (low to high).
- When less than six stations capable of reception are found, nothing is saved for the remaining preset switches.

Operating RDS (Radio Data system)

The RDS (Radio Data System) can receive signals such as traffic information via FM radio waves. In addition, if signal reception becomes poor, the system can automatically switch to another station with good reception so that the user can listen to the same program continuously.

Setting AF (Alternative Frequency)

If signal reception becomes poor, the system can automatically switch to another RDS station with good reception so that the user can listen to the same program continuously. Once an RDF station is tuned in, it is recorded in the AF list of this product.

- 1 Press **MENU** .
- 2 Touch **INFO.** in the MENU screen.
- 3 Touch **RDS** .
- 4 Touch **ON** or **OFF** for AF.
- 5 Touch **ENTER** .

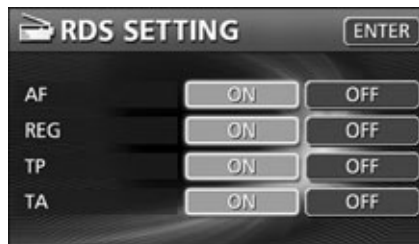

How to use the AM/FM radio

Setting REG

If signal reception becomes poor, the system can be set automatically switch to another RDS station with good reception that has the the same LOCAL PI (Program Identification) code. This setting can only be performed when AF is set to ON.

- 1 Press **MENU** .
- 2 Touch **INFO.** in the MENU screen.
- 3 Touch **RDS** .
- 4 Touch **ON** or **OFF** for REG.
- 5 Touch **ENTER** .



Receiving traffic information

Setting TP (Traffic Programming)

- 1 Press **MENU** .
- 2 Touch **INFO.** in the MENU screen.
- 3 Touch **RDS** .
- 4 Touch **ON** or **OFF** for TP.
 - “TP” appears in the radio screen when **ON** is touched.
- 5 Touch **ENTER** .



How to use the AM/FM radio

Setting TA (Traffic Announcements)

- 1 Press **MENU** .
- 2 Touch **INFO.** in the MENU screen.
- 3 Touch **RDS** .
- 4 Touch **ON** or **OFF** for TA.
 - "TA" appears in the radio screen when **ON** is touched.
- 5 Touch **ENTER** .



Receiving traffic information

When TP or both TP and TA are set to ON, traffic information is received as follows:

■ Receiving traffic information when TP is set to ON

[When the AUDIO SOURCE is FM radio]

Set TP to ON, and “TP” is displayed. If there is an available TP station in the AF list, the TP station is tuned in. If a TP station cannot be tuned in, the “TP” display will flash. When this happens, press and hold the TUNE/TRACK button for at least 2 seconds to select a TP station with favorable reception. “TP SEEK” is displayed while a TP station is being selected. If no TP station can be tuned in, “NOTHING” appears, and the original FM broadcast is received.

If signal reception becomes poor after a TP station has been received, press and hold the TUNE/TRACK button for at least 2 seconds to select a TP station with favorable reception. “TP SEEK” is displayed while a TP station is being selected.

[When the AUDIO SOURCE is something other than AM/FM radio]

Set TP to ON, and “TP” is displayed. If there is an available TP station in the AF list, the TP station is tuned in.

If a TP station cannot be tuned in, the “TP” display starts flashing and an automatic TP station search begins. If no TP station can be tuned in, “NOTHING” appears.

■ Receiving traffic information when both TP and TA are set to ON

[When the AUDIO SOURCE is FM radio]

Set TP and TA to ON, and “TA” is displayed. If there is an available TP station in the AF list, the TP station is tuned in. If a TP station cannot be tuned in, the “TA” display will flash and the automatic TP station search begins. “TP SEEK” is displayed while a TP station is being selected.

If no TP station can be tuned in, “NOTHING” appears, and the original FM broadcast is received.

When TA is set to ON, sound from the radio is muted automatically, allowing TA information to be heard when it is received. While TA information is being received, the system switches to traffic information interrupt mode and “TA INTERRUPT” is displayed on the screen.

[When the AUDIO SOURCE is something other than AM/FM radio]

Set TP and TA to ON, and “TA” is displayed. If there is an available TP station in the AF list, the TP station is tuned in. If a TP station cannot be tuned in, the “TA” display will flash and the automatic TP station search begins. When TA information is received, the current audio playback is stopped and automatically switched to output traffic information.

While TA information is being received, the system switches to traffic information interrupt mode and “TA INTERRUPT” is displayed on the screen.

How to use the AM/FM radio

EON (Enhanced Other Network) system

If the current TP station is not broadcasting traffic information or if the signal becomes weak when TP or TA is set to ON, the system automatically switches to another suitable TP station that is broadcasting traffic information using the EON AF list stored in the device. "EON" is displayed while this function is operating. When the current traffic information broadcast is finished, the the system returns to its previous TP station settings.

Reception of emergency broadcasts

If a PTY31 (emergency broadcast) is received, "ALARM" appears and PTY31 (emergency broadcasting) begins. If FM radio is not selected, all operations other than switching the SOURCE and switching the radio band become disabled.

Setting the volume for voice guidance

The volume for TA and PTY31 (emergency broadcasts) can be adjusted.

1 Turn **VOL** while TA or PTY31 is received.

- The volume level can be adjusted from 0 to 80.

Turn to the right: Volume UP (louder)

Turn to the left: Volume DOWN (quieter)

- The adjusted volume level is recorded, and the volume output is adjusted to that level the next time a TA or PTY31 broadcast is received.

Setting PTY (Program Type)

The RDS station genre can be selected. Programs of the selected genre will be received.

- 1 Touch **FUNC** in the FM operation screen.



- 2 Touch **PTY**.

- Each time **PTY** is touched, the genre will be switched in the order shown below.

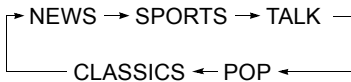

- When the genre is set to TALK, the switching order starts from TALK.
- If the station does not support program types, "NO PTY" is displayed.



- 3 While the selected PTY is displayed, press and hold **▶▶ ^** or **◀◀ v** until you hear a beep.

- The device will begin searching for a station that is broadcasting a program matching the selected PTY.
- When no matching programming can be found, "NOTHING" is displayed.

Turning off the radio

- 1 Press **⏻**.

- Press **⏻** again to turn on the radio and resume reception of the radio station (frequency) received before power was turned off.

1. How to use the CD player



Listening to a CD

Playback starts when a CD is inserted into the disc slot.

Listening to a CD when the display is raised

- 1** Press **VOL** or touch the SOURCE MENU RECALL switch once a CD has been inserted.
- 2** Touch **CD**.
 - Playback will begin.

Listening to a CD when the display is retracted

- 1 Press **VOL** .
- 2 Turn **VOL** to select CD.
- 3 Press **VOL** .





- Titles and track names can be displayed when they are recorded on the CD. Up to 28 characters can be shown in the display.
- Only characters recorded in ASCII code can be shown on the CD-TEXT display.
- The CD-TEXT display may not be able to show text information for discs with too many title characters recorded.
- There may be occasions when CD-R/RW CD-TEXT cannot be displayed.

How to use the CD player

Selecting a track

You can jump to the opening of a track you want to hear.



1 Press  or .

-  (up) : Selects next track
-  (down) : Selects previous track

Fast-forwarding/rewinding

It is possible to fast-forward or rewind the track being played.

1 Press and hold  or  until you hear a beep.

-  (up) : Fast-forward
-  (down) : Rewind

If you hear a beep while rewinding (fast-forwarding), the deck has switched to fast-forward (rewind) mode and will continue you remove until your finger from the button.

Repeating a track

1 Touch **FUNC**.

2 Touch **RPT**.

- Repeats the current track.
- The track will repeat until the function is canceled. Touch **RPT** again to cancel.

Playing tracks in random order

1 Touch **FUNC**.

2 Touch **RAND**.

- Plays tracks in random order.
- Random playback will continue until the function is canceled. Touch **RAND** again to cancel.
- At the end of each track the system arbitrarily chooses which track to play next. As a result, it is possible for the same track to be played multiple times in a row.

Turning off the CD player

1 Press  .

- Press again to resume playback.

1. How to use the MP3/WMA player

For safety considerations, some functions are disabled while the vehicle is in motion.



Example of an MP3/WMA file structure

Explanations are based on this example of an MP3/WMA file structure.

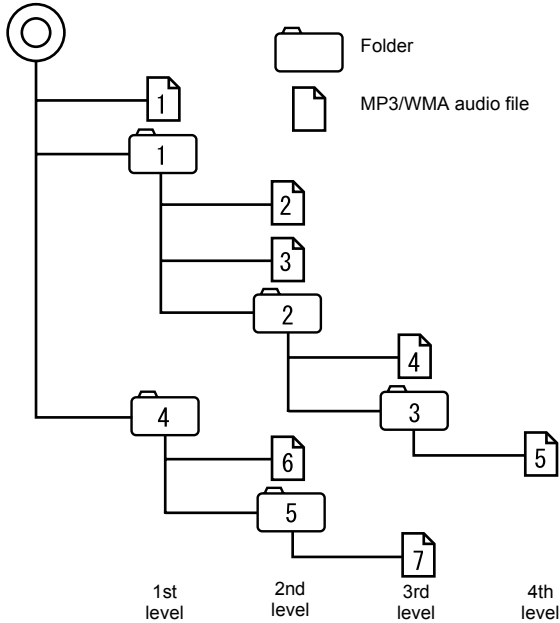

Playing MP3/WMA files

Playback starts automatically when a CD is inserted into the disc slot.

Playing MP3/WMA files when the display is raised

- 1 Press **VOL** or touch the SOURCE MENU RECALL switch once a disc has been inserted.
- 2 Touch **MP3 WMA**.
 - Playback will begin.
 - The CD player screen will be shown for about 2 seconds as the system checks whether the inserted CD is a music CD or an MP3/WMA.
 - Normally, tracks are played back in the order 1^a → 2^b → 3^b → 4^b → 5^b → 6^b → 7^b.
 - When multiple MP3/WMA files and folders are on the same level, they are played in ascending order by folder and file name.



Playing MP3/WMA files when the display is retracted

- 1 Press **VOL**.
- 2 Turn **VOL** to select CMP.
- 3 Press **VOL**.

Selecting a music file

A music file located within a folder can be selected.

Selecting with the file change switches



- 1 Touch the music file.
 - The currently selected file name and folder name will be shown in the display.
 - When 9 or more music files are located in the same folder, touch  or  to show data not currently displayed. (This function is not available when the vehicle is in motion.)

How to use the MP3/WMA player

Selecting with the TUNE/TRACK buttons

When several music files are located in the same folder, the next music file or previous music file can be selected with the track selection (track start point) buttons.

1 Press  or .

-  (up) : Selects next music file
-  (down) : Selects previous music file





- If music data and MP3/WMA data have been recorded on the same disc, playback is not possible.
- When an MP3/WMA file is being played, navigation operation will become slower. This is not a malfunction of the system.

Fast-forwarding/rewinding

It is possible to fast-forward or rewind within the current file.

1 Press and hold  or  until you hear a beep.

-  (up): Fast-forward
-  (down): Rewind

If you hear a beep while rewinding (fast-forwarding), the deck has switched to the fast-forward (rewind) mode and will continue until you remove your finger from the button.

Changing display of the current level

The folder level can be switched and displayed.

1 Touch  or **HOME** .

-  : Displays the next folder level up.
- **HOME** : Displays the level of the file currently being played.

Displaying the current level

Displays the file currently being played.

1 Touch **HOME** .

How to use the MP3/WMA player

Repeating the same music file

1 Touch **FUNC** .

2 Touch **RPT** .

- Repeats the current file.
- The file will repeat until the function is canceled. Touch **RPT** again to cancel.

Playing music files in random order

1 Touch **FUNC** .

2 Touch **RAND** .

- Files will be randomly selected from among all files at the same level as the folder currently being played.
- Plays files in random order.
- Random playback will continue until canceled. Touch **RAND** again to cancel.
- Touch **RPT** during random playback to repeat the file currently being played. Touch **RPT** again to return to random playback.
- At the end of each file the system arbitrarily chooses which file to play next. As a result, it is possible for the same file to be played multiple times in a row.



See page 72 for an example of an MP3/WMA file structure.

If **4** in the third level is being played and the display shows the folder and files of the second level (**2** **3**), and **2**), touch **HOME** to display the folder and file of the third level (**4** and **3**).

About the file information display

Folder names and file information (album name and track titles) recorded on the disc can be displayed. The number of characters that can be displayed is shown below.

Screen Display	
Folder/file names	Music file information
12 characters max.	14 characters max.

Displaying folder/file names

- 1 Press **AUDIO** to display the operation screen.



Displaying file information

- 1 Touch **TITLE**.
 - The **TITLE** switch will change to **TITLE OFF** when the file information is being displayed. Touch **TITLE OFF** to display the previous operation screen.



Turning off the MP3 player

- 1 Press **POWER**.
 - Press **POWER** again to resume playback.

How to use the MP3/WMA player

About MP3/WMA files

MP3 (MPEG-1 Audio Layer III) is a standard format for audio compression technology. By using the MP3 format, a file can be compressed to one-tenth its original size.

WMA (Windows Media™ Audio) is the audio compression format by Microsoft. This can compress files to a smaller size than MP3 can.

This unit has limitations on MP3/WMA file standards and the recorded media and formats that can be used. Be aware of the following points when recording MP3/WMA files.

Playable MP3 file standards

- Supported standards : MPEG1 Audio Layer III
- Supported sampling frequencies: 44.1, 48 (kHz)
- Supported bitrates : 64, 80, 96, 112, 128, 160, 192, 224, 256, 320 (kbps)
 - * Supports VBR.
 - * Does not support free format.
 - * Bitrates vary for MPEG-1 and MPEG-2.
- Supported channel modes : monaural, stereo, joint, dual

Playable WMA file standards

- Supported standards : WMA Ver. 7, 8, 9
- Supported sampling frequencies: 44.1, 48 (kHz)
- Supported bitrates : 48, 64, 80, 96, 128, 160 (kbps)
 - * VBR is supported.
 - * No support for reversible compression (loss-less compression)

Playable sampling frequencies and supported bitrates

		Sampling frequencies (Hz)	
		48 k	44.1k
		2 (ch)	2 (ch)
bitrates (bps)	160 k	○	○
	128 k	○	○
	96 k	×	○
	80 k	-	○
	64 k	×	○
	48 k	×	○
	VBR	○	○

- : Playable
- × : Not playable
- : No combination

How to use the MP3/WMA player

ID3 tag/WMA tag

MP3 and WMA files have an "ID3 tag/WMA tag" that allows input of text information so that data such as track titles and artists can be saved.

■ ID3 tag/WMA tag

		MP3	WMA
		Ver1.0, 1.1, 2.2, 2.3	Ver1.02.02
Input items	TITLE	30 characters	15 characters
	ARTIST		×
	ALBUM		
Characters displayed		ISO-8859-1	ISO-8859-1

Media

Media capable of playing MP3/WMA files include CD-ROM, CD-R and CD-RW discs.

Compared to CD-ROM media commonly used for music discs, CD-R discs are fragile in high temperature/high humidity environments and sections of the CD-R may become incapable of playback. Fingerprints or scratches on the disc may prevent playback or cause skipping.

Sections of a CD-R may deteriorate if left inside a vehicle for long periods of time.

It is also recommended that CD-R discs be kept in a light-blocking case because the discs are vulnerable to ultra-violet light.

Supported disc formats

The disc formats supported by this device are shown below.

- Disc formats: CD-ROM MODE1, CD-ROM XA MODE2 (Form1)
- File formats

■ ISO9660

	LEVEL 1	LEVEL 2
Folder name (max. number of characters)	8 characters	31 characters
File name (max. number of characters)	8 characters + 3 character file extension	31 characters
Characters displayed	Alphanumeric (ASCII code)	

■ Extended format

	ROMEO format	JOLIET format
Folder name (max. number of characters)	128 characters	64 characters *1
File name (max. number of characters)	128 characters *2	64 characters
Characters displayed	ASCII code	ASCII code

*1 Delimiter "." included

*2 Delimiter "." + extension included

- Maximum directory layers: 8 layers
- Total number of folders that can be written on a single disc: 255
- Total number of folders that can be written on a single disc: 512



Touch **TITLE** in the MP3/WMA operation screen to display up to 30 characters for an MP3 file, or 15 letters for a WMA file. (Refer to the section "**Displaying file information**" on page 77.)

How to use the MP3/WMA player

File names

Only files with the MP3/WMA file extension ".MP3/.WMA" will be recognized as MP3/WMA and played in the unit. Be sure to save MP3/WMA files with an ".MP3/.WMA" file extension.

Use capital letters when attaching file extensions.

Multi-sessions

Multi sessions are supported and CD-R/RW discs with recorded MP3/WMA files can be played. When recording using "Track at once", however, finalize the disc with session close or write protect.

Playing MP3/WMA files

When a disc containing an MP3/WMA file is inserted, all files on the disc will be checked before playback can begin. The check will be completed within approximately 10 seconds of the disc being inserted, and the first MP3/WMA file will begin playing. If the check is not completed within this period, the music or audio previously being played will resume. MP3/WMA playback can be started by touching **MP3 WMA**.

Sound is not emitted from the system while it is checking the files on the disc.

In order to speed up completion of the file check, it is recommended that you avoid recording files that are not MP3/WMA files and avoid creating unnecessary folders.

In addition, it is recommended that you record all data in a single session because it takes more time to acquire CD control information from a multi session disc.

While an MP3/WMA is being played, navigation operation will become slower. This is not a malfunction of the system.

MP3/WMA playing time display

It is possible that playing time will not be correct, depending on the writing condition of the MP3/WMA file.

* It is possible that playing time will not be correct when VBR Fast Up/Down is operated.

Display order of MP3/WMA file/folder names

Names of MP3/WMA folders and files within the same level are displayed in the following order.

1. MP3/WMA files displayed first, in ascending order of numbers, then letters.
2. Folders are displayed next, in ascending order of numbers, then letters.



If the ".MP3/.WMA" file extension is attached to a file other than an MP3/WMA file, that file will be mistakenly recognized by the unit as an MP3/WMA file and played, resulting in noise and static that can damage the speakers. Do not attach the ".MP3/.WMA" extension to any non-MP3/WMA files.

Making and playing MP3/WMA files

MP3/WMA files created by recording broadcasts, records, audio recordings, video recordings or live performances cannot be used for purposes other than personal entertainment without permission of the copyright holder as set forth in copyright law.

Downloading from Internet MP3/WMA music sites

There are many kinds of sites that distribute MP3/WMA files on the Internet, such as "pay per download" online shopping sites, "try before you buy" listening sites and free download sites. Follow the rules for each site (such as paying fees) and download according to site instructions.

Converting CD music to MP3/WMA files

Prepare a computer with commercially available MP3/WMA encoding software (conversion software). (Some encoding programs available on the Internet do not require payment.) Music data files in MP3/WMA format can be made by inserting the music CD into the CD-ROM drive of the computer and following the procedures of the MP3/WMA encoding software to compress the songs of the music CD. A 12cm music CD (having a maximum of 74 minutes of recording/650MB of data) can be compressed to 65MB (about 1/10 of the original size).

Writing to CD-R/RW discs

MP3/WMA files can be recorded on a CD-R/RW by using a CD-R/RW drive connected to a computer. Record by setting the recording format of the recording software to ISO9660 level 1 or level 2 (not including extension format).

Select CD-ROM (mode 1) or CD-ROM XA (mode2) for the disc format.

Playing back CD-R/RW discs

Insert a CD-R/RW disc containing recorded MP3/WMA files. The system will automatically determine whether the disc is a music CD or a CD-R/RW with MP3/WMA files and begin playing the disc. A music CD recorded onto a CD-R/RW can also be played. However, depending on the type of disc being used, playback may not be possible.



- A fixed bit rate of 128kbps and sampling frequency of 44.1kHz is recommended for obtaining stable audio quality at playback.
- Depending on the characteristics of a disc, the system may not be able to read CD-R and CD-RW discs.
- Because there are many types of MP3/WMA encoding software available, including commercial and freeware programs, audio quality may deteriorate, noise may be generated when playing starts and some recordings may not play, depending on the condition of the encoder and the file format.
- When files other than MP3/WMA files are recorded on a disc, the system may take some time to recognize the disc or it may not play.

1. How to use the Memory Stick player

The unit can play music data recorded on a Memory Stick Duo using ATRAC3 (audio compression technology).



Listening to Memory Stick data

Insert a Memory Stick Duo into the slot and attach the control panel.

Listening to Memory Stick data when the display is raised

- 1 Press **VOL** or touch the SOURCE MENU RECALL switch once a Memory Stick Duo has been inserted.
- 2 Touch **MEMORY STICK** .
 - Playback will begin.

Listening to Memory Stick data when the display is retracted

- 1 Press **VOL** .
- 2 Turn **VOL** to select MS.
- 3 Press **VOL** .







- This unit can only play music data recorded on MG Memory Stick Duos (white).
- This unit cannot play music data recorded using ATRAC3 Plus.
- The unit cannot be operated for about 4 seconds after an MG Memory Stick Duo has been inserted while the system is checking the data.
- If recorded on the Memory Stick Duo, the artist name, song title (track name), and other details can be displayed on the screen. Up to 28 characters can be shown in the display.
- If the number of plays and/or playback period is restricted, the relevant number/period is displayed on the screen.
- A message is displayed if the number of remaining plays reaches 0 or if the playback period has expired. (See page 155)

How to use the Memory Stick player

Selecting a track

You can jump to the opening of a track you want to hear.





1 Press   or  .

-   (up) : Selects next track
-   (down) : Selects previous track

Fast-forwarding/rewinding

It is possible to fast-forward/rewind within the current track.

1 Press and hold   or   until you hear a beep.

-   (up) : Fast-forward
-   (down) : Rewind

If you hear a beep while rewinding (fast-forwarding), the deck switched to fast-forward (rewind) mode and will continue until you remove your finger from the button.

Repeating a track

1 Touch **FUNC**.

2 Touch **RPT**.

- Repeats the current track.
- The track will repeat until the function is canceled. Touch **RPT** again to cancel.

Playing tracks in random order

1 Touch **FUNC** .

2 Touch **RAND** .

- Plays tracks in random order.
- Random playback will continue until the function is canceled. Touch **RAND** again to cancel.
- At the end of each track the system arbitrarily chooses which track to play next. As a result, it is possible for the same track to be played multiple times in a row.

Turning the Memory Stick off

1 Press  .

- Press  again to resume playback.

1. How to use the CD changer

An optional CD changer can be connected and used.

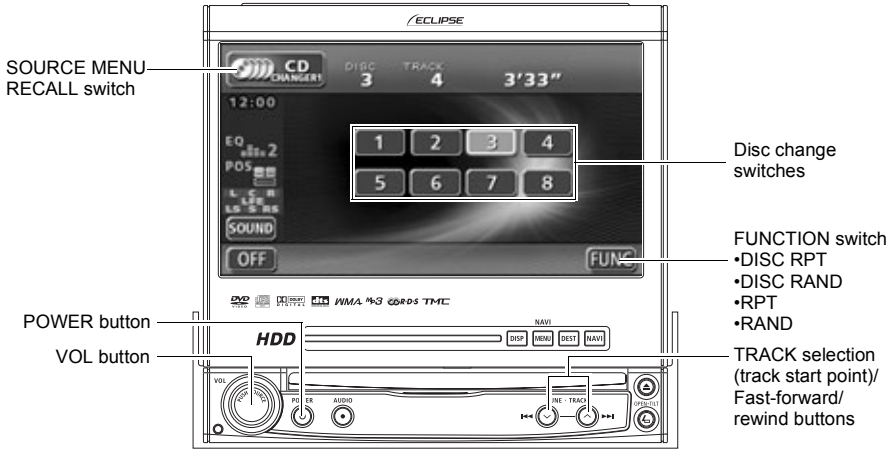

Listening to a CD

Listening to a CD when the display is raised

- 1 Press **VOL** or touch the SOURCE MENU RECALL switch.
- 2 When only one CD changer is connected, touch **CD CHANGER1**. When two CD changers are connected, touch **CD CHANGER1** or **CD CHANGER2**.

Listening to a CD when the display is retracted

- 1 Press **VOL**.
- 2 Turn **VOL** to select CDC1. When two CD changers are connected, select CDC1 or CDC2.
- 3 Press **VOL**.

Selecting a track

See "How to use the CD player" on page 70.

Fast-forwarding/rewinding

See "How to use the CD player" on page 70.

Selecting a CD

A CD can be selected from among all the discs in the changer.

- 1 Touch one of the disc change switches.
 - The number for the selected CD will change color.

Repeating a track or CD

Repeating the current track

See "How to use the CD player" on page 70.

Repeating the current CD

- 1 Touch **FUNC** .
- 2 Touch **DISC RPT** .
 - Touch once to repeat the CD. Repeat will continue until canceled. Touch **DISC RPT** again to cancel.

How to use the CD changer

Playing tracks in random order

Playing tracks on the current CD in random order

See "How to use the CD player" on page 70.

Playing tracks on all CDs in random order

1 Touch **FUNC** .

2 Touch **DISC RAND** .

- Setting once will start random playback. Random playback will continue until canceled. Touch **DISC RAND** again to cancel.
- At the end of each track the system arbitrarily chooses which track to play next. As a result, it is possible for the same track to be played multiple times in a row.



- A disc change switch is displayed for each disc tray in the changer, but only the disc change switches that correspond to a currently loaded tray can be selected.
- No operation is possible when there are no discs loaded into the CD changer.
- If there are 2 CD changers connected, use **CD CHANGER1** and **CD CHANGER2** to switch between the optional CD changer deck and the main CD changer.

Turning off the CD changer

1 Press  .

- Press  again to resume playback.

1. Before using the DVD player

This unit can output the high quality images and high quality digital sound of DVD videos. It is also possible to switch between different languages recorded on the DVD video (dubbing, subtitles, etc.), and with videos having several angles of the same scene recorded, the preferred angle can be selected and played.

DVD video characteristics

About multiple languages

Some DVD discs have dialog recorded in several different languages. On these discs, the language can be switched during playback in the same way as multilingual TV broadcasts.



This river, which runs through the center of the town is...



Cette riviere, laquelle court au travers le centre de la ville est...

About multiple angles

Some DVD discs have a single scene recorded from several different angles (multiple angle), and the preferred angle can be switched during playback.

* Depending on the disc, multiple angles may not be recorded.



The angle of the image is changed.



This unit includes copyright protection technology used in accordance with US patents and other intellectual property rights owned by Macrovision Corporation and other entities. Use of this copyright protected technology requires approval from Macrovision Corporation and the technology must not be used for audiovisual purposes aside from general household use without special approval from Macrovision Corporation. Modification and disassembly of this technology is prohibited.

About subtitles



Some DVD discs have subtitles recorded in several different languages, and the subtitles can be switched during playback. The video can also be played without any subtitles displayed.



About discs

About playable discs

This unit conforms to PAL color television methods, so please use discs that display "PAL" on the disc or package.

Playable disc types and their marks	Size/playing surface	Maximum playing time
	12cm/single-sided single-layer double-layer	<MPEG2> 133 min. 242 min.
	12cm/double-sided single-layer double-layer	266 min. 484 min.







Before using the DVD player

About region codes

Some DVD discs display a  (region code). This mark (a number) shows the geographical region where the disc can be played. This unit can only play discs with region codes "2" or "ALL". If you play discs with any region code other than those shown above, a "This disc cannot be played" message is displayed. It is possible that discs bearing no region code can not be played as a result of geographical restrictions.

About marks displayed on discs

The following marks may be displayed on a DVD disc or its package.

Mark		Meaning
		Shows the number of voice tracks.
		Shows the number of subtitle languages.
		Shows the number of filmed angles.
		Shows available aspect ratios (television screen horizontal to vertical ratio). ● "16 : 9" is widescreen, "4 : 3" is standard screen.
		Shows the playable region code. ● ALL indicates worldwide. A number indicates a specific region code. "2" is the region number for Europe.



Playing conditions are determined by the creator of the DVD/software. Some functions may not perform during operation because the unit is playing the disc according to content specifications intended by the software creator. Be sure to consult the explanatory material provided with the disc to be played.

About DVD disc structures

Videos and tracks recorded on a DVD are divided into many segments.

Large segments are called "titles", and each title has a number ("title number"). Title segments are further divided into smaller segments called "chapters", and each chapter has a number ("chapter number").

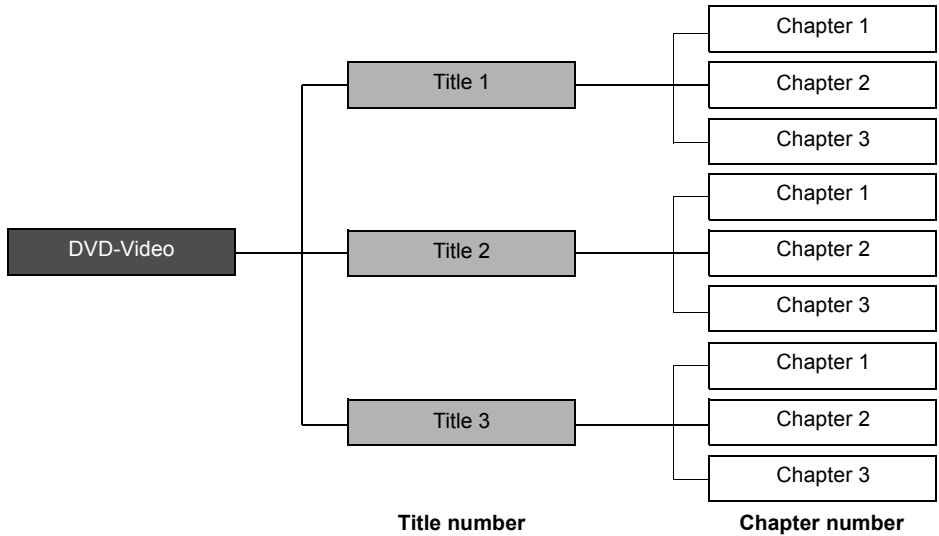

Before using the DVD player

Operation flow

The section below describes the flow for functions such as operation and search of images and setting defaults for the DVD player.

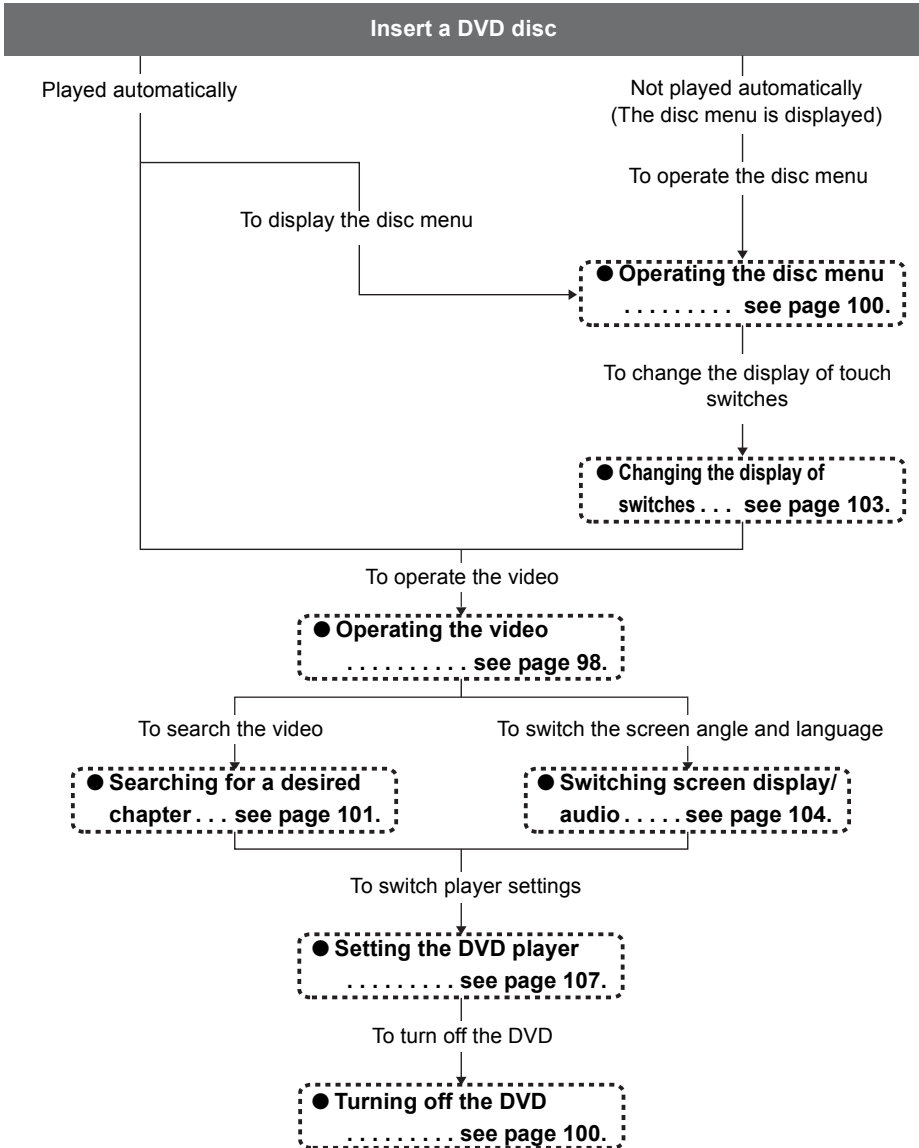

2. How to use the DVD player

For safety reasons, DVDs can only be played when the ignition is switched to ON or ACC and the vehicle is completely stopped with the parking brake applied. (Only sound is output if a DVD is played while the car is in motion.)



Watching a DVD

Playback starts automatically when a DVD is inserted into the disc slot.

- 1 Press **VOL** or touch the SOURCE MENU RECALL switch when a DVD has been inserted.
- 2 Touch **DVD**.
 - Playback will begin.
 - To display the operation switches (touch switches), press **AUDIO** or touch the screen.



- Information for items such as touch switches will be displayed for about 6 seconds. Press **AUDIO** or touch the screen to display again.
- Depending on the disc, automatic playback or playback may not function unless a menu recorded on the disc is selected. (See "Operating the disc menu" on page 100)

How to use the DVD player

Operating the video

Playing the video

- 1 Touch .





Fast-forwarding/rewinding

It is possible to fast-forward or rewind through the video being played.

Fast-forwarding/rewinding using the panel buttons

- 1 Press and hold  or  until you hear a beep.

-  (up) : Fast-forward
-  (down) : Rewind

If you hear a beep while rewinding (fast-forwarding), the deck has switched to the fast-forward (rewind) mode and will continue until you remove your finger from the button.

Fast-forwarding/rewinding using the touch switches

- 1 Touch  or .

- If you hear a beep while rewinding (fast-forwarding), the deck has switched to the fast-forward (rewind) mode and will continue until you remove your finger from the switch.



Pausing the video

1 Touch **⏸**.

- While paused (**⏸**), briefly touch **⏩** for slow motion playback.



Stopping the video

1 Touch **■**.



How to use the DVD player

Operating the disc menu

It is possible to use the menu recorded on the disc.

1 Touch **NEXT** in the DVD operation screen.

2 Touch **MENU** or **TOP MENU**.

3 Touch .

4 Touch , , , or  to select the video you want to play.

5 Touch **ENTER**.



Turning off the DVD

1 Press .

● Press  again to resume playback (audio only).



Recorded menu items will differ by disc. The disc is played according to its content so all functions may not be available.

Searching for a desired chapter

It is possible to search for a particular video segment by title and chapter or by menu number (number for divided segments).

Searching by chapter

- 1 Press **▶▶** **^** or **◀◀** **v** .
 - **▶▶** **^** (up) : Selects next chapter
 - **◀◀** **v** (down) : Selects previous chapter



Searching by title number

- 1 Touch **SEARCH** in the DVD operation screen.
 - The title number input screen will be displayed.



- 2 Enter the title number by touching **-**, **+**, **-10**, and **+10** .
 - Touch **-** or **+** to change the title number in steps of one.
 - Touch **-10** or **+10** to change the title number in steps of ten.

- 3 Touch **ENTER** .



How to use the DVD player

Searching by menu number

1 Touch **NEXT** in the DVD operation screen.

2 Touch **+**.

3 Touch **NUMBER**.

- The menu number input screen will be displayed.



4 Enter the menu number by touching **-**, **+**, **-10**, and **+10**.

- Touch **-** or **+** to change the menu number in steps of one.
- Touch **-10** or **+10** to change the menu number in steps of ten.

5 Touch **ENTER**.



Changing the touch switch display

Display of the touch switches can be changed or turned off.

Turning off the touch switches

1 Touch **OFF** in the DVD operation screen.

- Press **AUDIO** or touch the screen to display the touch switches again.



Changing the touch switch display locations

1 Touch **NEXT** in the DVD operation screen.

2 Touch .

3 Touch **POSITION**.

- The position of the touch switch will move up or down as you touch the screen.



How to use the DVD player

Switching screen display/audio

It is possible to change the language for subtitles and audio, as well as the display angle for the video being played.

Changing the angle

When several angles of a scene are recorded on a disc, the angle can be switched.

1 Touch **NEXT** in the DVD operation screen.

2 Touch **ANGLE** when the multiple angle mark is displayed.

- The angle number will be displayed.



3 Touch **ANGLE**.

- The angle number will change and the angle of the video will be switched.

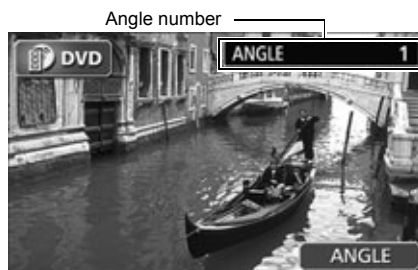

Each time **ANGLE** is touched, the angle will change in order from among the angles recorded on the disc.

Switching subtitle language

When subtitles in several languages are recorded on a disc, the subtitles can be switched.

1 Touch **NEXT** in the DVD operation screen.

2 Touch **SUB TITLE** .

- The subtitle number will be displayed.



3 Touch **SUB TITLE** .

- The subtitle number will switch and the subtitle language will change.

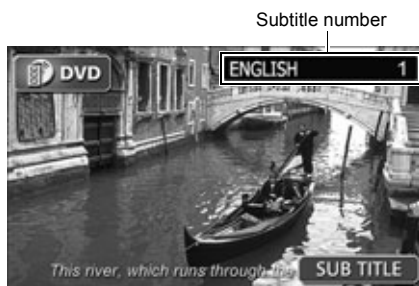

- Each time **SUB TITLE** is touched, the subtitle language will change in order from among the subtitles recorded on the disc.
- Depending on the disc, it may only be possible to change subtitles in the top menu.

How to use the DVD player

Switching dubbed audio language

If several audio languages are recorded on a disc, the languages can be switched.

1 Touch **NEXT** in the DVD operation screen.

2 Touch **AUDIO** .

- The audio number and language will be displayed.



3 Touch **AUDIO** .

- The audio number will change and the audio language will be switched.

Audio number and language



- Each time **AUDIO** is touched, the audio language will change in order from among the languages recorded on the disc.

Language 1 → Language 2 → Language...



- Depending on the disc, it may only be possible to change audio languages in the top menu.
- The dts format is not supported by this deck, so no audio will be emitted if "dts audio" is selected on a disc that enables it. In this case, select "Dolby Digital audio", which should also be recorded on the DVD video.
- dts is a registered trademark of the US company Digital Theater Systems, Inc.

Setting the DVD player

The language preferences for voices, subtitles and menu display used during DVD playback can be set in advance. Optional display of the multiple angle mark, viewer restriction and other functions can also be set.

1 Touch **NEXT** in the DVD operation screen.

2 Touch **SET** .

3 Touch **SETUP** .

- The SET UP screen will be displayed.

4 Touch the appropriate touch switch to progress to the next page and perform settings.

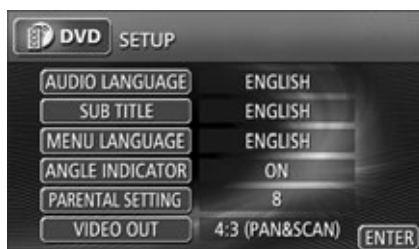

How to use the DVD player

Touch switch	Function	Page
AUDIO LANGUAGE	Sets the voice language for video playback.	See below
SUB TITLE	Sets the subtitle language for video playback.	Next page
MENU LANGUAGE	Sets the language of the displayed menus.	Page 110
ANGLE INDICATOR	Sets the display of the multiple angle mark.	Page 111
PARENTAL SETTING	Restricts the types of DVD videos that can be played.	Page 112
VIDEO OUT	Sets screen size.	Page 113

Setting the audio language

The preferred language for video playback can be selected.

1 Touch **AUDIO LANGUAGE** in the SETUP screen.

2 Touch the preferred language.

- Touch **OTHER** to set a language other than those displayed on the screen.



Input a code

1 Touch **OTHER** in the AUDIO LANGUAGE setting screen.

2 Input a language code.

- For language codes see "Table of language codes" on page 115.

3 Touch **ENTER**.



ATTENTION

After changing settings in the SETUP screen, the DVD will stop if you press one of the buttons that switches screens (**AUDIO** or **VOL**) without touching **ENTER**. Touch  in the operation screen to start playback again. (See page 98)

Subtitle language settings

The preferred subtitles for the video playback can be selected.

1 Touch **SUB TITLE** in the SET UP screen.

2 Touch the preferred language.

- Touch **OTHER** to set a language other than those displayed on the screen.



Input a code

1 Touch **OTHER** in the SUB TITLE setting screen.

2 Input a language code.

- For language codes see "**Table of language codes**" on page 115.

3 Touch **ENTER** .



Language switching cannot be performed if the selected language is not recorded on the disc.

How to use the DVD player

Menu language settings

Allows selection of a preferred menu language from those recorded on the disc.

- 1 Touch **MENU LANGUAGE** in the SETUP screen.
- 2 Touch the preferred language.
 - Touch **OTHER** to set a language other than those displayed on the screen.



Input a code

- 1 Touch **OTHER** in the MENU LANGUAGE setting screen.
- 2 Input a language code.
 - For language codes see "**Table of language codes**" on page 115.
- 3 Touch **ENTER**.



Language switching cannot be performed if the selected language is not recorded on the disc.

Setting the display of the multi-angle mark (angle selection mark)

The multi-angle mark can be set to display or not display during video playback.



- 1 Touch **ANGLE INDICATOR** in the SETUP screen.
 - Touching the switch switches between "ON" and "OFF" mode.

- 2 Touch **ENTER**.



Setting the multi-angle mark display to "ON" will display the multi-angle mark in the upper right corner of the screen when multiple angles are available on the disc.

How to use the DVD player

Viewer restriction settings

This function allows a viewing restriction to be set so that discs with adult content or violence will not be available to children. The viewer restriction can be set at different levels to match restriction ratings.

- 1 Touch **PARENTAL SETTING** in the SETUP screen.
- 2 Enter a pass code by touching one number at a time.
- 3 Touch **ENTER**.
- 4 Touch the preferred restriction level.
- 5 Touch **ENTER**.



- Viewer restriction cannot be set for discs that do not have a viewer restriction level recorded.
- Be sure to enter a pass code number. If a number is not entered, it will not be possible to set the viewer restriction.
- The pin code shown in the upper section will be displayed as [----] when a pin code has not yet been set.
- Once the pass code has been set, the pass code will be required for subsequent use of this function. Do not forget the pass code. If you forget your pass code, the default setting (no pass code set) can be restored by touching **CLEAR** 10 times.
- Viewer restriction levels are classified in 3 types.
 - Level 1 Plays only DVD software intended for children. (Playing of DVD software intended for general audiences or adult audiences is prohibited.)
 - Levels 2 - 7 . . . Plays only DVD software intended for children or general audiences. (Playing of DVD software intended for adult audiences is prohibited.)
 - Level 8 Plays all DVD software. (Factory setting)

Changing video output

1 Touch **VIDEO OUT** in the SETUP screen.

- Each time the switch is touched, the screen size changes in the order shown below.

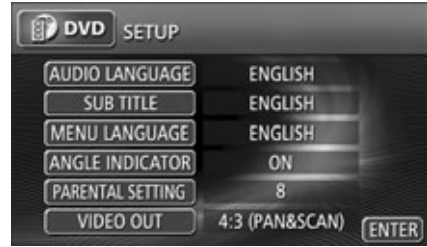
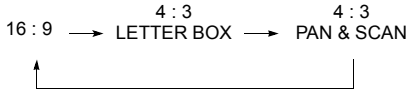

- **16 : 9**

The video is displayed at normal width. DVD software recorded in 4 : 3 size will be displayed with black left and right edges or will be expanded to the left and right.

- **4 : 3 (letter box)**

The video is displayed with black upper and lower edges.

DVD software recorded in 4 : 3 size will be displayed exactly at screen size (4 : 3).

- **4 : 3 (pan & scan)**

The video is displayed with the right and left edges cut off. DVD software recorded in 4 : 3 size will be displayed exactly at screen size (4 : 3).

2 Touch **ENTER** .



When another monitor such as a rear seat monitor is being used, the size of the video being displayed in the rear seat monitor will differ according to the video output size set at the deck (front).



Viewing images with a wide screen privately poses no problem legally. However, if the images are compressed or expanded for public or commercial viewing purposes, this action may infringe upon the rights of the creators of those images which are protected by applicable copyright laws. Please exercise caution.

How to use the DVD player

Setting DVD individual monitor playback

When an optional rear monitor is connected, it is possible to switch the screen of the device to AUDIO SOURCE or the navigation system screen while the rear monitor continues to play the DVD.

1 Press **NAVI MENU** .

2 Touch **INFO.** in the MENU screen.

3 Touch **AV SELECTOR** .

4 Touch **ON** or **OFF** for DVD PLAY.

- **ON** : If the screen is switched to AUDIO SOURCE or the navigation system screen, the optional rear monitor continues to play the DVD. (The optional rear monitor continues to play the VTR during VTR playback as well.)

OFF : The video is same as that shown in the screen of the device.

5 Touch **ENTER** .



Table of language codes

These codes are used to specify the language for audio tracks, subtitles and on-screen menu displays.

Input code	Language
1001	Japanese
0514	English
0618	French
0405	German
0920	Italian
0519	Spanish
1412	Dutch
1821	Russian
2608	Chinese
1115	Korean
0512	Greek
0101	Afar
0102	Abkhazian
0106	Afrikaans
0113	Amharic
0118	Arabic
0119	Assamese
0125	Aymara
0126	Azerbaijani
0201	Bashkir
0205	Byelorussian
0207	Bulgarian
0208	Bihari
0209	Bislama
0214	Bengali
0215	Tibetan
0218	Breton
0301	Catalan
0315	Corsican
0319	Czech
0325	Welsh
0401	Danish
0426	Bhutani
0515	Esperanto
0520	Estonian
0521	Basque
0601	Persian
0609	Finnish
0610	Fiji
0615	Faroese
0625	Frisian
0701	Irish
0704	Scots- Gaelic
0712	Galician
0714	Guarani
0721	Gujarati

Input code	Language
0801	Hausa
0809	Hindi
0818	Croatian
0821	Hungarian
0825	Armenian
0901	Interlingua
0905	Interlingue
0911	Inupiak
0914	Indonesian
0919	Icelandic
0923	Hebrew
1009	Yiddish
1023	Javanese
1101	Georgian
1111	Kazakh
1112	Greenlandic
1113	Cambodian
1114	Kannada
1119	Kashmiri
1121	Kurdish
1125	Kirghiz
1201	Latin
1214	Lingala
1215	Laothian
1220	Lithuanian
1222	Latvian
1307	Malagasy
1309	Maori
1311	Macedonian
1312	Malayalam
1314	Mongolian
1315	Moldavian
1318	Marathi
1319	Malay
1320	Maltese
1325	Burmese
1401	Nauru
1405	Nepali
1415	Norwegian
1503	Occitan
1513	Oromo
1518	Oriya
1601	Panjabi
1612	Polish
1619	Pashto
1620	Portuguese

Input code	Language
1721	Quechua
1813	Rhaeto-Romance
1814	Kirundi
1815	Romanian
1823	Kinyarwanda
1901	Sanskrit
1904	Sindhi
1907	Sangho
1908	Serbo-Croatian
1909	Sinhalese
1911	Slovak
1912	Slovenian
1913	Samoaan
1914	Shona
1915	Somali
1917	Albanian
1918	Serbian
1919	Siswati
1920	Sesotho
1921	Sundanese
1922	Swedish
1923	Swahili
2001	Tamil
2005	Telugu
2007	Tajik
2008	Thai
2009	Tigrinya
2011	Turkmen
2012	Tagalog
2014	Setswana
2015	Tonga
2018	Turkish
2019	Tsonga
2020	Tatar
2023	Twi
2111	Ukrainian
2118	Urdu
2126	Uzbek
2209	Vietnamese
2215	Volapuk
2315	Wolof
2408	Xhosa
2515	Yoruba
2621	Zulu

1. How to use the VTR

Video tapes can be played by connecting a commercially available VTR deck. For safety reasons, videos can be played only when the ignition is switched to ON or ACC and the vehicle is completely stopped with the parking brake set. (If the VTR mode is activated while the vehicle is in motion, only the audio will be played. If the optional rear monitor is connected, the video is shown on the rear monitor only.)

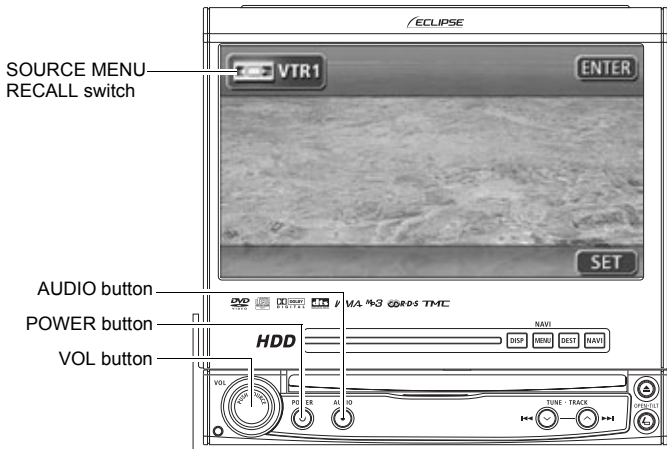

Viewing the VTR

- 1 Press **VOL** or touch the SOURCE MENU RECALL switch.
- 2 Touch **VTR1**.
 - The VTR screen will be displayed.
 - Press **AUDIO** or touch the screen to display the VTR operation screen.

Switching to the VTR setting screen

Switch to the VTR setting screen in VTR mode to perform the following operations.

- To adjust sound quality (EQ, POS etc.)
- To switch screen modes (wide mode)

1 Touch **SET** .

- Touch **←BACK** to return to the VTR operation screen.



- After switching to the VTR operation screen, touch switches will be displayed for about 6 seconds. Pressing **AUDIO** will display them again.
- The VTR operation screen can be displayed by touching the screen, even when the VTR is playing.
- It is possible that the image may not be displayed correctly depending on the connected devices.

How to use the VTR

Switching the display format

The display format (PAL or NTSC) can be switched according to the type of VTR connected to the device.

- 1 Press **NAVI MENU** .
- 2 Touch **INFO.** in the MENU screen.



- 3 Touch **SETTING** .



- 4 Touch **AUTO** , **PAL** or **NTSC** for VIDEO CONVERT.

- **AUTO** :Automatically switched according to the connected VTR system.

PAL :Only PAL system video is played.

NTSC :Only NTSC system video is played.



- 5 Touch **ENTER** .

Turning off VTR mode

- 1 Press **POWER** .
 - Press **POWER** again to resume playback.
 - Press **VOL** and then touch **VTR1** to resume playback of the video that was being played before the power was turned off.

1. Before adjusting sound quality

Functions available when the optional 5.1 ch decoder/AV matrix unit is connected

The following table shows the finer audio adjustments that can be performed when the optional 5.1 ch decoder/AV matrix unit is connected.

Item		Function	Page
Parametric EQ		Perform a 5-band parametric equalizer adjustment on each channel (front, rear, center) and a 1-band adjustment on the woofer for a total of a 16-band adjustment.	127
POSITION		Sound localization can be adjusted according to the number and position of passengers in order to obtain optimum acoustic effects.	132
FADER/BALANCE		The left/right/front/rear balance can be adjusted.	133
Speaker Settings	Speaker System	The settings can be adjusted according to the connected speaker system (1-way 4 speaker system or front 3-way speaker system).	139
	Time Alignment	The delay time and level of sound from each speaker can be adjusted in order to correct any phase mismatches in the sound resulting from the listening position.	140
	Crossover	Allocate specified frequency bands to each speaker for improved sound integration.	143
	Sub-woofer level	When a sub-woofer is connected, the preferred output level for the audio can be set.	145
	Sub-woofer phase	The merging of sound between the front and rear speakers and the sub-woofer can be improved by selecting the phase. Switch to a phase that lets the speakers combine without any disharmony.	146
	Speaker Level	Adjust the frequency band output to fit the size of the speakers connected to the unit.	147
	Speaker Size	Set the speaker size.	148
Surround System Settings	Dolby Pro Logic II	Achieve surround sound by moving from 2 channel stereo to 5.1 channel sound.	135
	COMPRESSION	Set the dynamic range (difference between the lowest and highest audio signal).	138
	Center Width	When Dolby Pro Logic II is set to Music and the center speaker is set to LARGE or SMALL, sound from the center speaker is distributed to the left and right front speakers.	137
	Center Level	Adjust the output level of the center speaker.	136
	Rear Level	Adjust the output level of the rear speakers.	136

Before adjusting sound quality

Item	Function	Page
Harmonizer	When original sounds are converted to MP3/WMA format, frequency ranges that are not normally audible to the human ear are compressed. The harmonizer can be used to play back these compressed sounds at as close to their original form as possible so that clear and powerful sound can be enjoyed.	134
Loudness	The loudness control may be turned on to emphasize low and high frequencies at low volume levels. Loudness compensates for the apparent weakness of low and high frequencies at low volume by boosting the bass and treble levels.	134
ECLIPSE Web Services Sound Effect Customizations	Download sound adjustment data from the ECLIPSE Web Services that matches the vehicle's interior and store it in the unit.	124

About parametric EQ

A variety of materials are used inside a vehicle to manufacture the seats and windows, and these materials absorb and reflect sound in different ways. The parametric equalizer lets you adjust the peaks and dips of the frequency characteristics inside the vehicle to compensate for these differences.

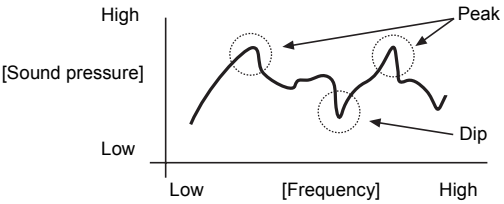

An “equalizer” is a function that corrects these peaks and dips in order to flatten frequency characteristics. However, with a normal graphic equalizer, the median frequency and the Q (sharpness and band width) are fixed, so that when neighboring bands are corrected, there is a limit to the amount of distortion in the peak and dip characteristics that can be corrected. A “parametric equalizer” lets you adjust the median frequency, Q (sharpness and band width) and gain to variable levels, so that you can make fine adjustments to spot areas of the frequency band.

[Parametric equalizer characteristics]

1. Median frequency can be varied.

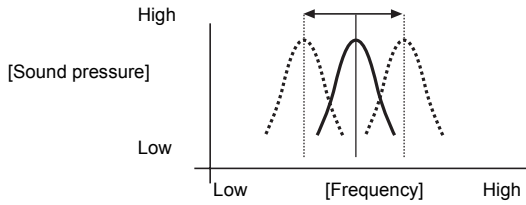

2. Gain can be varied.

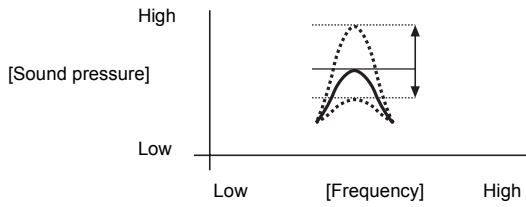

3. Q (sharpness/band width) can be varied.

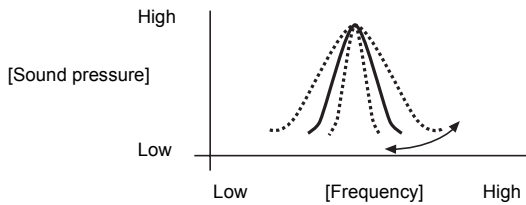

Before adjusting sound quality

About time alignment

With vehicle audio systems, the installation position of the speakers and the position of the listener mean that the distances from the listener to the left and right speakers are almost always different. These differences in the distance from the listener to each speaker in turn means that the time taken for the sound to reach the listener is different for each speaker. The result of this is that the phases of each speaker (biases) become mismatched and the sound becomes unnatural, as though the sound stage were not wide enough. The “time alignment” function corrects the time taken for the sound waves to reach the listener in order to set the optimum phase for the listening position. This makes the sound more expansive as though it were being listened to on a sound stage.

The basic adjustment method involves measuring the actual distances to each speaker and calculating the differences in distance relative to the most distant speaker in order to derive the delay time for the sound from each speaker.

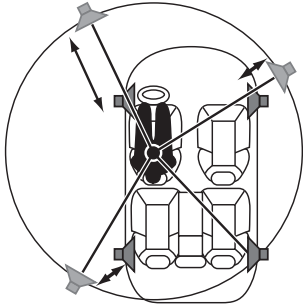

About crossover

The frequency band that is stored by audio media such as CDs is a fairly wide range from 20 Hz to 20 kHz, and it is difficult for a single speaker to be able to play back all frequencies in such a wide range.

Because of this, several speakers can be used, with different frequency bands (such as treble, medium and bass) allotted to each speaker so that wide frequency ranges can be played back. The “Crossover” function is used to allot the frequency ranges that are to be played back by each speaker in accordance to the installed speaker units and the layout of the speakers, in order to obtain the maximum level of performance from the speakers and to provide the most stable frequency characteristics.

The crossover function includes a high-pass filter (HPF) for playing back treble sounds, and a low-pass filter (LPF) for playing back bass sounds. In addition, the HPF and LPF are used in combination in order to play back sounds in the mid range.



fc*: Cutoff frequency

For example, when adjusting the HPF, frequencies that are lower than the specified frequency are progressively dampened, rather than simply not being played back at all. The “slope” adjustment function is the function that is used to adjust these dampening characteristics.

The slope characteristics of a filter are such that with larger slope values (for example 12 dB/oct), the slope becomes steeper, and so the amount of sound mixing in with neighboring bands becomes less so that only the target band is played back. However, it also causes the merging of sound between speakers to become poorer and can result in greater distortion.

- The crossover function is a filter that allocates specified frequency bands.
- A high-pass filter (HPF) is a filter that cuts out frequencies that are lower than the specified frequency (bass range) and allows higher frequencies (treble range) to pass through.
- A low-pass filter (LPF) is a filter that cuts out frequencies that are higher than the specified frequency (treble range) and allows lower frequencies (bass range) to pass through.
- The slope is the signal level at which frequencies that are one octave higher or one octave lower are dampened.

Before adjusting sound quality

About ECLIPSE Web Services sound effect customizations

The parametric equalizer, time alignment and crossover settings can be adjusted using this unit, or through the ECLIPSE website. Contact your local retailer for more information on performing these settings.

2. Adjusting sound quality

Sound quality can be adjusted in all audio operation screens.

Displaying the sound adjustment screen

- 1 Touch **SOUND**.
 - Touch **SET** in the VTR operation screen, or **NEXT** in the DVD operation screen followed by **SET** to display the **SOUND** switch.



- Touch any of the following buttons on the sound adjustment screen to display the corresponding adjustment screen.

● Sound adjustment screen



● Parametric equalizer adjustment screen



● Position setting screen



FADER BALANCE

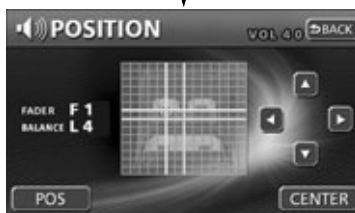

● Fader/Balance setting screen

SETTING

● Setting screen (see next page)

➔ Continue to the next page

Adjusting sound quality

●Setting screen



SP LEVEL

●Speaker level setting screen



SP SETTING

●Time alignment adjustment screen



X-OVER

●Crossover setting screen



Adjusting PEQ (Parametric equalizer)

If the optional 5.1 ch decoder/AV matrix unit is connected, the parametric equalizer can be used to perform a 5-band adjustment of each of the front, center, and rear channels, and a 1-band adjustment of the woofer for a total of a 16-band adjustment. Each band can be set to the following median frequencies:

Channel	Band	Adjustable frequency (Hz)
Front Center Rear	1 to 5	20, 25, 31.5, 40, 50, 63, 80, 100, 125, 160, 250, 315, 500, 630, 1k, 1.25k, 2k, 2.5k, 3.15k, 4k, 5k, 6.3k, 8k, 10k, 12.5k, 16k, 20k
WOOFER	1	20, 25, 31.5, 40, 50, 63, 80, 100, 125, 160, 250



It is not possible to set more than one band in the same channel to the same median frequency. Either change the median frequency of the current band, or change the center frequency of another band.

Adjusting sound quality

Adjusting/Saving a PEQ

- 1 Touch **PEQ** in the sound adjustment screen.
- 2 Touch **FRONT**, **REAR**, **CENTER** or **WOOFER** to select the channel to be adjusted.

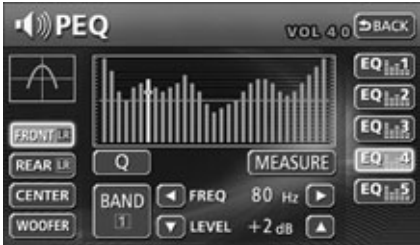

- 3 Touch **BAND** to select the band to be adjusted.

- Each time **BAND** is touched, the band will be changed in the order shown below.

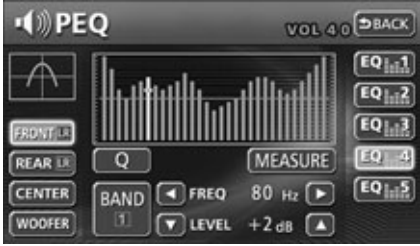
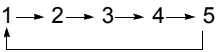

- 4 Touch **◀** or **▶** for **FREQ** to select the frequency to be adjusted.

- **▶** : Increase frequency
- **◀** : Decrease frequency

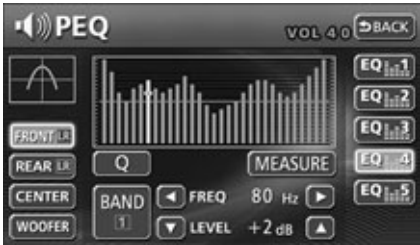

- 5 Touch **▲** or **▼** for **LEVEL** to adjust the frequency level.

- The frequency level can be adjusted -10 dB to 10 dB (in units of one)
- **▲** : Increase level
- **▼** : Decrease level

6 Touch **Q** to select the Q curve pattern.

- Each time the switch is touched, the Q curve pattern will be changed in the order shown below.

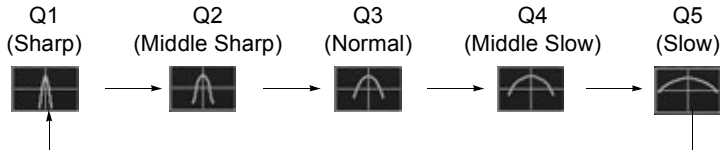
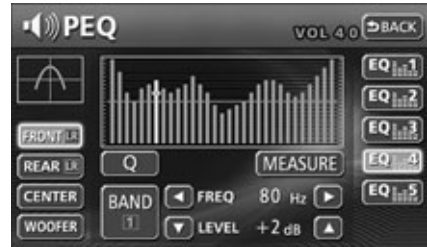

7 Repeat the steps 2 through 6 to change the setting for each channel and band.

- It is not possible to set more than one band in the same channel to the same median frequency.

8 Touch the switch you want to use to save (**EQ1** to **EQ5**) until you hear a beep.

- Save the PEQ settings for future use.
- Touch **BACK** after making settings. The PEQ mode adjustments will be saved and the system will return to the previous operation screen.



Adjusting sound quality

Selecting a PEQ pattern from memory

- 1 Touch the **EQ1** to **EQ5**.
 - The preset pattern stored in memory will be retrieved.
 - Touch **BACK** after making settings. The PEQ mode adjustments will be saved and the system will return to the previous operation screen.



Measuring/Displaying frequency characteristics

Frequency characteristics inside the vehicle can be measured and displayed on the display. The measurement result can be referred to when adjusting the parametric equalizer. These measurements are also necessary to automatically correct parametric equalizer setting using ECLIPSE Web Services sound effect customizations.

- 1 Connect the accessory microphone with a optional 5.1 ch decoder/AV matrix unit.
 - Align the microphone with the actual ear position and attach it to the headrest or other appropriate fixture. (Attach the microphone using tape or string.)

To avoid writing measurement results to the “Memory Stick Duo”

- 2 Touch **MEASURE** briefly (less than 1 second).
 - After touching the switch, a 10-second countdown begins. Leave the vehicle during that time.
 - Pink noise will be output from the speakers and measurement of the frequency characteristics will start.
 - When measurement is complete, the measurement results will appear on the display.



- Touch **CANCEL** to cancel measurement.

To write measurement results to a “Memory Stick Duo”

- 2 Insert the “Memory Stick Duo”.
- 3 Touch **MEASURE** for more than 2 seconds, until you hear a beep.

- After touching the switch, a 10-second count down begins. Leave the vehicle during that time.
- Pink noise will be output from the speakers and measurement of the frequency characteristics will start.
- When measurement is complete, the measurement results will appear on the display. Measurement results for each channel can be displayed by selecting the desired channel.
- Measurements can be written to a “Memory Stick Duo” and corrected automatically using the ECLIPSE website.
- Touch **CANCEL** to cancel measurement.



Because this function is designed to make measurement of frequency characteristics easier, slight errors may occur in the measurement data under some circumstances. The measurements obtained are not equivalent to the precise measurements that can be made by professional measuring devices.

Adjusting sound quality

Adjusting POS (Positioning selector)

Sound localization can be adjusted according to the number and position of passengers in order to obtain optimum acoustic effects.

A seat's sound localization can be adjusted simply by touching a switch.

1 Touch one of the seat images displayed in the POSITION setting screen to switch the sound localization for that seat.

- The selected position will be indicated in a yellow box. Touch the seat again to cancel the selection. The four positions shown in the table below can be set.
- Touch **OFF** to cancel all settings.
- Touch **←BACK** after making settings. The position will be saved and the system will return to the previous operation screen.



Touch switch	Function	Touch switch	Function
	Acoustics optimized for left side seat		Acoustics optimized for both front seats
	Acoustics optimized for right side seat		Acoustics optimized for rear seats



- You cannot set POS (Positioning selector) at the same time as adjusting the balance (next page) or time alignment.
- This product is configured for vehicles with left-hand drive.

Setting the balance

The left/right/front/rear balance can be adjusted so that sound from all speakers arrives at the listener's ears at the same time.

1 Touch **FADER BALANCE** in the POSITION setting screen to display the volume balance adjustment screen.



2 Touch the screen at the preferred balance point.

- To make fine adjustments, touch **▲**, **▼**, **◀**, or **▶**.
- Touch **CENTER** to set the volume balance to the center position.
- Touch **BACK** after making settings. The set volume balance will be saved and the system will return to the previous operation screen.
- To set the position again, touch **POS** and repeat the steps above.



- You cannot set the balance at the same time as adjusting POS (Positioning selector) (previous page).
- Touch and hold **▲**, **▼**, **◀** or **▶** while making fine adjustments to adjust values continuously. Adjustment will lock when it reaches the center value, and **▲**, **▼**, **◀** or **▶** must be touched again to continue adjustment.

Adjusting sound quality

Setting LOUDNESS

Audio can be modulated to correct for insufficient bass and treble when listening at low volume.

1 Touch **ON** or **OFF** for LOUDNESS.

- The selected touch switch will turn light blue.



Setting the harmonizer

It is possible to set the sound quality boost level to automatically regenerate harmonics such as reverberation, depth, and tone lost in compression, producing a much clearer sound.

1 Touch **LOW**, **HI** or **OFF** for HARMONIZER.

- **LOW** : Low level of correction
- **HI** : High level of correction
- **OFF** : No correction



Setting/Adjusting the surround system

Dolby Digital (5.1 ch), DTS (5.1 ch), LPCM, and Dolby Pro Logic II are supported when the optional 5.1 ch decoder/AV matrix unit is connected. Playing discs recorded using these technologies allows the listener to enjoy theater-quality sound within a limited space.

Setting the Dolby Pro Logic II

Dolby Pro Logic II expands sound recorded in stereo (2 ch) for a rich listening experience. Different modes may be selected for different media types.

- 1 Touch **SETTING** in the sound adjustment screen.
- 2 Touch **MUSIC**, **MOVIE**, **4 ch ST** or **OFF** for the Dolby Pro Logic II.
 - Touch **←BACK** after making settings. The sound adjustment mode adjustments will be saved and the system will return to the previous operation screen.



Switch	Effectiveness
Music	Select when playing an audio CD.
Movie	Select when playing a DVD or VTR recorded in stereo (2 ch).
4 ch ST	Select when stereo (2 ch) sound is played through 4 speakers (4 ch).
OFF	Turns Dolby Pro Logic II OFF.

Adjusting sound quality

Setting the CENTER LEVEL

Adjusts the dialog and music output level heard from center speaker.

1 Touch ▲ or ▼ for CENTER LEVEL.

- The center level can be adjusted within -10 to 10 (in units of one).

▲ : Increase the level.

▼ : Decrease the level.

- Touch **BACK** after making settings. The sound adjustment mode adjustments will be saved and the system will return to the previous operation screen.



Setting the REAR LEVEL

Adjusts the dialog and music output level heard from rear speaker.

1 Touch ▲ or ▼ for REAR LEVEL.

- The rear level can be adjusted within -10 to 10 (in units of one).

▲ : Increase the level.

▼ : Decrease the level.

- Touch **BACK** after making settings. The sound adjustment mode adjustments will be saved and the system will return to the previous operation screen.



Setting the CENTER WIDTH

When Dolby Pro Logic II is set to MUSIC and the center speaker is set to LARGE or SMALL, sound from the center speaker is distributed to the left and right front speakers.

1 Touch ▲ or ▼ for CENTER WIDTH.

- The center width level can be adjusted within 0 to 7 (in units of one).

▲ : Increase the level.

▼ : Decrease the level.

- Touch ↶BACK after making settings. The sound adjustment mode adjustments will be saved and the system will return to the previous operation screen.



Adjusting sound quality

Setting the COMPRESSION

Compression adjusts the sound sensation range, or the difference between maximum and minimum when playing a DVD with Dolby Digital (5.1 ch) or DTS (5.1 ch). Raising the numerical value of the compression level will narrow the sound range so that dialog and voice will be easier to hear even when background sounds are intense.

1 Touch **SETTING** in the sound adjustment screen.



2 Touch **▲** or **▼** for COMPRESSION.

- Continue touching **▲** to set "OFF", or **▼** to set "FULL". See the following table for adjustment levels and their functions.
- Touch **BACK** after making settings. The compression setting mode adjustments will be saved and the system will return to the previous operation screen.



Adjustment Level	Function
OFF	Compression function effect is off.
1 to 7	Compression function effect can be adjusted in a middle range.
FULL	Compression function effect is at maximum.

Setting/Adjusting the speakers

Settings and adjustments can be made to fit the speakers connected to the unit.

The following settings and adjustments can be performed when the optional 5.1 ch decoder/AV matrix unit is connected.

- Speaker system
- Time alignment
- Crossover
- Speaker size
- Speaker level

Setting the speaker system

The settings can be adjusted according to the connected speaker system (1-way 4 speaker system or front 3-way speaker system).

1 Touch **1WAY** or **3WAY** for more than 5 seconds in the sound adjustment screen.

- Touch **←BACK** after making settings. The sound adjustment mode adjustments will be saved and the system will return to the previous operation screen.



Adjusting sound quality

Adjusting time alignment

The delay time and level of the sound from each speaker can be adjusted in order to correct any phase mismatches in the sound resulting from the listening position.

In addition, the optional 5.1 ch decoder/AV matrix unit has a function for automatically correcting time alignment.

Manual adjustment

1 Touch the **SETTING** in the sound adjustment screen.

2 Touch the **SP SETTING** in the setting screen.



3 Touch **▲** or **▼** for each speaker to adjust the delay time.

- The delay time can be adjusted within 0.0 to 10.0 ms (in units of 0.1 ms).

▲ : Increase the time

▼ : Decrease the time

- Touch **BACK** after making settings. The time alignment mode adjustments will be saved and the system will return to the previous operation screen.

- When the 1 WAY speaker setting is selected



- When the 3 WAY speaker setting is selected





- Refer to the following for the method of calculating the delay time.

$$A = (B - C) / 34$$

A: Delay time (ms)

B: Distance from listening position to the farthest speaker (cm)

C: Distance from listening position to the speaker to be adjusted (cm)

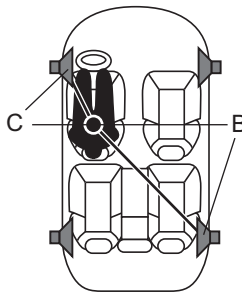

<Example>

Listening position: Driver's seat (left)

B: 200 (cm)

C: 50 (cm)

Delay time = $[200 \text{ (cm)} - 50 \text{ (cm)}] / 34 = \text{Approx. } 4.4 \text{ ms}$

Adjusting sound quality

Automatic adjustment

1 Connect the accessory microphone with an optional 5.1 ch decoder/AV matrix unit.

- Align the microphone with the actual ear position and attach it to the headrest or other appropriate fixture. (Attach the microphone using tape or string.)

2 Touch **AUTO** .

- After touching the switch, a 10-second countdown begins. Leave the vehicle during that time.
- Pink noise will be output from the speakers and setting of the time alignment will start.
- Touch **AUTO** to cancel setting.
- Touch **BACK** after making settings. The time alignment mode adjustments will be saved and the system will return to the previous operation screen.



- Automatic time alignment adjustment cannot be performed for the sub-woofer.
- When the 3 WAY speaker setting is selected, automatic time alignment adjustment cannot be performed.

Adjusting crossover

Allocate specified frequency bands to each speaker for improved sound integration.

- 1 Touch **SETTING** in the sound adjustment screen.
- 2 Touch **X-OVER** in the setting screen.
- 3 Touch individual speakers to select the speaker to be adjusted.
 - Each time **FRONT MID** is touched, HPF (High Pass Filter) and LPF (Low Pass Filter) are switched. (When 1 WAY is selected for the speaker system, HPF (High Pass Filter) and LPF (Low Pass Filter) cannot be switched.)
 - When 1 WAY is selected for the speaker system, **FRONT HI** and **FRONT MID-L** cannot be selected.



- When the 1 WAY speaker setting is selected



- When the 3 WAY speaker setting is selected



Adjusting sound quality

4 Touch **◀** or **▶** for FREQUENCY to select the cut off frequency.

- **▶**: Increase cut off frequency
- **◀**: Decrease cut off frequency
- The following cut off frequencies can be selected.

Speaker	Cut off frequency (Hz)
Front (HI, MID, MID-L) Center Rear	100, 125, 160, 200, 250, 315, 400, 500, 630, 800, 1k, 1.25k, 1.6k, 2k, 2.5k, 3.15k, 4k, 5k, 6.3k, 8k, 10k, 12.5k, 16k, 20k
WOOFER	20, 25, 31.5, 40, 50, 63, 80, 100, 125, 160, 200, 250



5 Touch **SLOPE** to select the slope.

- Each time **SLOPE** is touched, the slope will be changed in the order shown below.

PASS → 6 dB/oct → 12 dB/oct → 18 dB/oct → 24 dB/oct

- Touch **↩BACK** after making settings. The crossover mode adjustments will be saved and the system will return to the previous operation screen.



Adjusting sub-woofer output level

When a sub-woofer is connected, the preferred output level for the audio can be set.

- 1 Touch **SETTING** in the sound adjustment screen.
- 2 Touch **X-OVER** in the setting screen.
- 3 Touch **WOOFER** .
- 4 Touch **▲** or **▼** for LEVEL to adjust the sub-woofer output level.
 - **▲** : Increase the level
 - **▼** : Decrease the level
 - Touch **↶BACK** after making settings. The sub-woofer output level mode adjustments will be saved and the system will return to the previous operation screen.



Adjusting sound quality

Setting phase control

The merging of sound between the front and rear speakers and the sub-woofer can be improved by selecting the phase. Switch to a phase which lets the speakers combine without any disharmony.

- 1 Touch **SETTING** in the sound adjustment screen.
- 2 Touch **X-OVER** in the setting screen.
- 3 Touch **WOOFER** .
- 4 Touch **NORMAL** or **REVERSE** to select the phase control.
 - Touch **BACK** after making settings. The phase control adjustments will be saved and the system will return to the previous operation screen.



Adjusting speaker levels

- 1 Touch **SETTING** in the sound adjustment screen.
- 2 Touch **SP LEVEL** in the setting screen.
- 3 Touch **▲** or **▼** for each speaker to adjust the speaker level.

- The speaker level can be adjusted within -10 to 0 dB (in units of 0.1 dB).

▲ : Increase the level.

▼ : Decrease the level.

- Touch **←BACK** after making settings. The speaker level mode adjustments will be saved and the system will return to the previous operation screen.



- When the 1 WAY speaker setting is selected

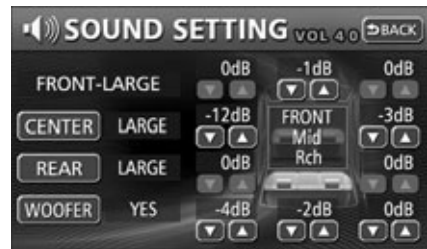

- When the 3 WAY speaker setting is selected

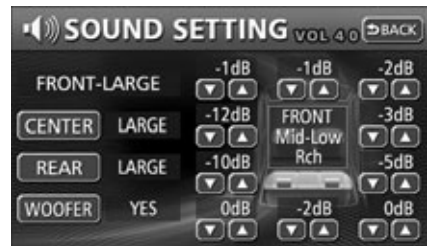

Adjusting sound quality

Adjusting speaker size

- 1 Touch **SETTING** in the sound adjustment screen.
- 2 Touch **SP LEVEL** in the setting screen.
- 3 Touch **CENTER**, **REAR**, and **WOOFER** to set the speaker size.

- Each time switch for each speaker is touched, the speaker size will be changed in the order shown below.

CENTER/REAR:

LARGE → SMALL → NONE



WOOFER:

YES ↔ NO



The FRONT speaker is always set to "LARGE".

■ Speaker settings and functions

Speaker	Size	Function
Center	NONE	Distributes output to the center speaker to the front left and right speakers.
	SMALL	This setting is used when the speakers connected to the unit are unable to output frequencies lower than 100Hz. (Frequencies lower than 100 Hz will not be output.)
	LARGE	This setting is used when the speakers connected to the unit are able to output frequencies lower than 100 Hz.
Rear	NONE	Distributes output to the center speaker to the front left and right speakers.
	SMALL	This setting is used when the speakers connected to the unit are unable to output frequencies lower than 100 Hz. (Frequencies lower than 100 Hz will not be output.)
	LARGE	This setting is used when the speakers connected to the unit are able to output frequencies lower than 100 Hz.
Woofer	YES	Outputs sound from the sub-woofer.
	NO	Does not output sound from the sub-woofer.

Adjusting sound quality

Importing sound data

Sound data adjusted using the ECLIPSE website can be downloaded to a “Memory Stick Duo” and imported into the unit. For more information, contact your local retailer.

- 1 Insert the “Memory Stick Duo” to be used to store the sound data.
- 2 Press **NAVI MENU** .
- 3 Touch **INFO.** in the MENU screen.
- 4 Touch **DATA** .
- 5 Touch **LOAD** for E-iSERV DATA.
 - This switch can be used to store sound data. For more information, contact your local retailer.



3. Display settings

Screen settings when the optional 5.1 ch decoder/AV matrix unit is connected

Up to two external monitors can be connected when the 5.1 ch decoder/AV matrix unit is connected. Separate images can be displayed on each external monitor.

External monitor image settings

Select the image to be displayed on the external monitors.

1 Press **NAVI MENU** .

2 Touch **INFO.** in the MENU screen.

3 Touch **AV SELECTOR** .

4 Touch **VTR 1** , **VTR 2** or **HEAD UNIT** to select an image.

5 Touch **ENTER** .



If a VTR or DVD player is not connected to the 5.1 ch decoder/AV matrix unit, no image will be displayed.

4. How to use AUX

It is possible to connect a portable audio player or similar devices to a DIGITAL terminal of the 5.1 ch decoder/AV matrix unit for playback.

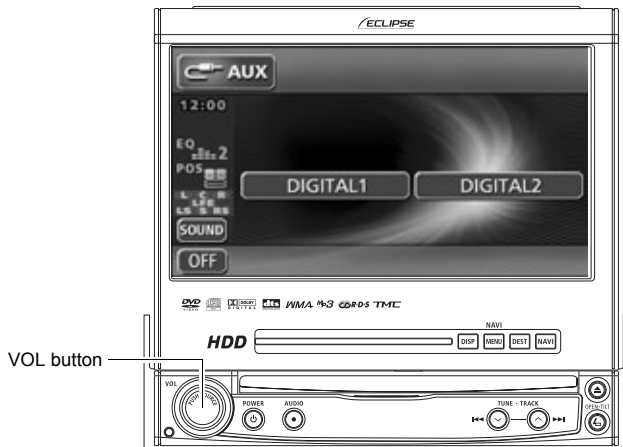

Listening to AUX

Switching to AUX using the touch switches

- 1 Press **VOL** or touch the SOURCE MENU RECALL switch when a portable audio player is connected.
- 2 Touch **AUX**.

Switching to AUX using the panel buttons

- 1 Press **VOL**.
- 2 Turn **VOL** to select **AUX**.
- 3 Press **VOL**.

Switching the AUX input

The AUX input can be switched depending on the terminals connected to the 5.1 ch decoder/AV matrix unit.

- 1 Touch **DIGITAL1** or **DIGITAL2** to switch the input mode.



1. Important Points

If one of these messages appears

If any of the following messages are displayed, check the unit while referring to the cause and corrective action columns.

Message	Cause	Corrective action
CD SEEK	The CD changer is searching for discs when a magazine has been inserted in the CD changer.	Wait until the unit has finished identifying the type of disc.
CD DOOR OPEN	The door of the CD changer is open.	Close the door of the CD changer.
CHECK DISC	The CD/MP3-WMA/DVD is dirty or has been inserted upside down.	Clean the disc if it is dirty. Insert the disc correctly if it is upside down.
NO DISC NO CD	There is no disc in the CD/MP3-WMA/DVD player or CD changer.	Load a music disc.
CD ERROR DVD ERROR DISC ERROR	The CD/MP3-WMA/DVD player or CD changer will not move for some reason.	Eject the disc. *1
	The temperature of the CD/MP3-WMA/DVD player or CD changer has become unusually high.	Wait a moment for the unit to cool down. Do not perform any other operations. *2
NO CD MAGAZINE	There is no magazine in the CD changer.	Load a magazine.
CD OO CHECK	The OO slot in the CD changer has a CD that cannot be read.	Check for a properly loaded music CD.
PASS CODE INCORRECT	Displayed when the pass code has been entered incorrectly.	Enter the correct pass code.
This Memory Stick is not available.	The inserted Memory Stick Duo type is not supported.	Check that the Memory Stick Duo is a type supported by this unit. (See page 21)
No Memory Stick.	An MG Memory Stick Duo has not been inserted.	Insert an MG Memory Stick Duo.
No Music data.	There is no playable music data recorded on the MG Memory Stick Duo.	Insert an MG Memory Stick Duo containing playable music data.
Checking Memory Stick.	The Memory Stick Duo is being checked.	Checking the Memory Stick Duo may take a short while. Wait a moment for the message to disappear before using.
Please check Memory Stick.	The Memory Stick Duo cannot be played because of static electricity.	Wait a moment, then re-insert and attempt to play again.

- *1 If the unit still will not work after the disc is ejected, contact your local retailer.
- *2 If this error occurs, wait a moment for the changer to cool down. When the temperature inside the unit returns to normal, the message will disappear and playback will start. If the message does not disappear after waiting for a long period, contact your local retailer.

Messages	Cause	Corrective action
This Memory Stick is not available.	You have tried to save data to the hard disc from a Memory Stick Duo not supported by this unit.	Check that the Memory Stick is a type supported by this unit. (See page 21)
There are no playable files.	There is no playable music data on the MG Memory Stick Duo.	Check that the Memory Stick contains recorded music data.
Can not read disc due to guard.	You tried to play data protected by playback restriction.	Try playback again after retrieving the data.
HDD has stopped. (Overheating)	The temperature inside the hard disc has become unusually high.	Wait a moment for the unit to cool down. Do not perform any other operations.
HDD has stopped. (Cooling)	The temperature inside the hard disc has become unusually low.	Wait a moment. Do not perform any other operations until the unit warms up.
There is no database to update.	There is no update data on the MG Memory Stick.	Check that the Memory Stick contains update data.
PARENTAL LOCK ENABLED	Viewing restrictions are enabled.	Change the setting for viewing restrictions and start again. (See page 112)
THIS FUNCTION IS CURRENTLY DISABLED	A function that has been disabled was selected with the menu.	Follow the directions on the screen and start again.
	A function that cannot be used while the vehicle is in motion was selected.	Stop the vehicle.
INVALID CODE	A number not supported was input for selecting a language code.	Input a valid language code.
REGION CODE ERROR	The region code (controlled region for playback) of the disc is not acceptable.	Check that the DVD is a type supported by this unit. (See page 94)
Requested chapter or title not found	The selected chapter/title does not exist.	Select a chapter/title that is on the disc.

Important Points

Before asking for repairs

Slight differences in operation can sometimes be mistaken for malfunctions, so check the following table before requesting any repairs.

If the following fail to solve the problem, contact your local retailer.

Symptom	Possible reason	Corrective action
The screen is dark for a brief period when the power is turned on at low temperatures.	This is a characteristic of LCDs.	This is not a malfunction. Wait for a brief period.
The display is distorted for a brief period after the power is turned on.	This is a characteristic of LCD backlighting.	This is not a malfunction. The display will stabilize after a brief period.
No sound comes out.	Volume is poorly adjusted.	Press the volume switch and check volume.
Sound comes out of only one side (left or right, front or back).	A speaker cord is disconnected.	Check the connections of the speaker cords.
	Volume is poorly adjusted.	Check the left/right volume adjustments.
Sound quality does not change even after making adjustments.	The adjusted audio quality is not included in the radio broadcast or disc.	Check by changing the radio station or disc.
A CD/DVD will not go into the deck.	Power is not turned on.	Turn the vehicle ignition switch to ACC or ON.
	A disc is already inserted and you are trying to insert a second disc.	Eject the previously inserted CD/DVD and insert the preferred CD/DVD.
A CD/DVD cannot be played.	There is water condensation in the deck.	Do not use the deck for a while and then try using it again. (See page 18)
	There is a large scratch or warp in the CD/DVD.	Insert a different CD/DVD.
	The CD/DVD is very dirty.	Clean the CD/DVD. (See page 19)
	The CD/DVD is upside down.	Insert the CD/DVD correctly. (See page 19)
Memory Stick playback not possible	The inserted CD/DVD type is not supported.	Insert a CD/DVD that is supported by the unit. (See page 18, page 19)
	The inserted Memory Stick Duo type is not supported.	Insert a Memory Stick Duo that is supported by the unit. (See page 21)
CD CHANGER1 / CD CHANGER2 not displayed on the screen.	The CD changer is not completely connected.	Check the connections to the CD changer.
Audio is output, but not video.	The screen has been turned off with the screen OFF button.	Press AUDIO or NAVI . (See page 52)
Audio is output, but not DVD video. (With vehicle stopped.)	The parking brake has not been set.	Set the parking brake.

Symptom	Possible reason	Corrective action
Neither video nor audio is output.	The vehicle ignition switch has not been turned on.	Turn the vehicle ignition switch to ACC or ON.
	The connection cord is not completely connected.	Check the connections to each connection cord.
There is a point of light on the display.	At least 99.99% of the pixels on the LCD panel are effective, but it is possible that 0.01% of the pixels may not light or may stay lighted.	This is not a defect, so please use the deck in this condition.
The Audio screen is distorted by electrical noise.	Are electrical devices that generate electrical noise being used in the vicinity of the unit? For example, devices generating high voltage (such as those that generate negative ions) or high frequency electromagnetic waves (cell phones or two-way radios)	Use such equipment as far away from the unit as possible. If such equipment continues to affect the unit, even from a distance, refrain from using such equipment while the unit is in operation.

2. Other

Products equipped with Dolby Digital

Manufactured under license from Dolby Laboratories.

"Dolby" and the double-D symbol are trademarks of Dolby Laboratories.

Confidential Unpublished Works. ©1992-1997 Dolby Laboratories, Inc. All rights reserved.

Manufactured under license from Dolby Laboratories, Inc.

Dolby and the double-D symbol are trademarks of Dolby Laboratories.

Confidential Unpublished Works. ©1992-1997 Dolby Laboratories, Inc. All rights reserved.



Products equipped with Macrovision

This unit includes copyright protection technology used in accordance with US patents and other intellectual property rights owned by Macrovision Corporation and other entities. Use of this copyright protection technology requires approval from Macrovision Corporation and the technology must not be used for audiovisual purposes aside from general household use without special approval from Macrovision Corporation. Modification and disassembly of this technology is prohibited.

3. Glossary

CD-R (Compact Disc Recordable)	This is a disc that can only be recorded once. Recorded data cannot be deleted. There are two types of CD-R, one having a capacity of 650MB (74 minutes of music), the same as a regular CD, and the other having a capacity of 700MB (80 minutes of music).
CD-DA (Compact Disc Digital Audio)	This disc is the standard for recording and playing music data. One track is recorded with one song, and a maximum of 74 minutes of music can be recorded.
CD-RW (Compact Disc ReWritable)	This disc uses a phase transformation method that enables recording and deleting of data as many times as needed. The capacity is 700MB (80 minutes of music).
EQ (Equalizer)	This enables the setting of emphasis on certain sounds in the bass-treble range to achieve the preferred tonal profile. Levels can be adjusted to personal preference, enhancing enjoyment of the music.
MP3 (MPEG-1 Audio Layer-3)	MP3 stands for MPEG Audio Layer III, the standard format for audio compression technology. MP3 can compress files to one-tenth of their original size because the technology compresses inaudible sounds found in areas of the spectrum beyond human hearing.
LPCM (Linear PCM)	This is an abbreviation for Linear Pulse Code Modulation, a signal recording method used with music CDs. A music CD is recorded at 44.1kHz/16 bit, but a DVD is recorded at 48kHz/16 bit ~ 96kHz/24 bit, enabling a DVD to be played with higher sound quality than a music CD.
MPEG	This is an abbreviation for Moving Picture Experts Group and is pronounced "empeg". It is the international standard for moving image compression. With DVDs, this method is also used to compress and record digital audio.
Copy Control CD	This is a CD that has controls for preventing computers from copying and ripping (taking audio information recorded on a compact disc and using it as data to create a file).
UDF (Universal Disc Format)	This is one format for use with optical discs not reliant on the OS. It is used with media such as DVDs and CD-RW discs.

Glossary

Track	The single division for a song on a music CD is called a track.
SCMS (Serial Copy Management System)	With digital recording, the deterioration of audio quality is very low. Therefore digital recording equipment regulates, for the sake of copyright protection, the using of a sound source copied using a digital signal to be used to make further copies of the same data. This is what the SCMS (Serial Copy Management System) does.
Viewing Restriction	This is a DVD video function that “Restricts playing of discs that support viewing restrictions, in accordance with the regulated levels of each country.” Restrictions differ by DVD video and may completely prevent playing of the video or may skip or insert alternate scenes for extreme scenes.
Title	This is the largest unit for divisions of video or songs recorded on a DVD video. Usually a single movie is treated as a title by video software and a single album (or song) is treated as a single title by music software. The consecutive numbers attached to titles are called title numbers.
Chapter	This is a unit for divisions of video or songs recorded on a DVD video, but it is a smaller unit than a title. A single title is made up of several chapters, and the consecutive numbers attached to chapters are called chapter numbers.
Multi-Angle	This is one feature of DVD video, where viewpoints of the same scene are changed by recording from several different angles (camera positions), allowing the viewer to select the preferred angle.
Multi-Language	This is one feature of DVD video, where the same scene is recorded with several different languages and subtitles, allowing the viewer to select the preferred language.
Region code	DVD players and DVD discs have a region code that enables playing by geographic marketing regions, and a disc cannot be played if the number recorded on the disc is not included in the region codes of the player. See page xx for details on region codes.

4. Topic index

About screen and sound adjustment

[Regarding screen adjustment]

- To make the audio operation screen or VTR screen easier to see
 - "Displaying the image adjustment screen" P51
- To turn off the screen
 - "Turning the screen off" P52
- To change the wallpaper
 - "Setting the Pic-CLIP" P39
- To set the screen to wide mode
 - "Switching screen mode" P53

[Regarding audio adjustment]

- To change the volume
 - "Adjusting the main volume" P27
- To turn on/off the guide tone used at switch operation
 - "Setting the BEEP tone" P27
- To adjust sound quality
- To adjust high and low sounds
 - "Adjusting EQ (equalizer)" P31
- To switch the sound image localization to match the position of passengers
 - "Adjusting POS (Positioning selector)" P34
- To adjust the left/right/front/rear balance
 - "Setting the balance" P35

Topic index

- To adjust the MP3 sound
 - "Setting the harmonizer" P38
- To add sharpness when listening at low/high volumes
 - "Setting LOUDNESS" P36

About using AM/FM radio

- To play the radio
 - "Listening to the AM/FM radio" P56
- To search for a radio station
 - "Selecting radio stations" P57
- To save radio stations
 - "Saving radio stations" P59
- To receive RDS station
 - "Operating RDS (Radio Data system)" P61

About using the CD player and CD changer

- To play a CD
 - "Listening to a CD" P68
- To select a song or CD
 - "Selecting a track" P70
 - "Selecting a CD" P89
- To repeat the song or CD currently being played
 - "Repeating a track" P70
 - "Repeating a track or CD" P89
- To play songs in a different order
 - "Playing tracks in random order" P70, 90
- To fast-forward or rewind
 - "Fast-forwarding/rewinding" P70

About using the MP3/WMA player

- To play an MP3 file
 - "Playing MP3/WMA files" P73
- To select a music file or folder to listen to
 - "Selecting a music file" P73
- When you want to return to a level or don't know the current level
 - "Changing display of the current level" P75
- To repeat the same music file
 - "Repeating the same music file" P76
- To play songs in a different order
 - "Playing music files in random order" P76
- To change the file information
 - "About the file information display" P77
- To learn about MP3
 - "About MP3/WMA files" P78
- To learn about making MP3 files
 - "Making and playing MP3/WMA files" P83

About using the Memory Stick player

- To listen to Memory Stick data
 - "Listening to Memory Stick data" P84
- To select a song
 - "Selecting a track" P86
- To repeat the current song
 - "Repeating a track" P86
- To play songs in a different order
 - "Playing tracks in random order" P87

Topic index

About using the DVD player

- To play a DVD video
 - "Watching a DVD" P97

- To learn about discs
- To learn about the marks displayed on discs and packages
 - "About marks displayed on discs" P94
- To learn about discs that can be played
 - "About playable discs" P93
- To learn about disc structures
 - "About DVD disc structures" P95

- To operate the menu recorded on a disc
 - "Operating the disc menu" P100

- To operate the video being played
 - "Operating the video" P98

- To select/search for a video
 - "Searching by chapter" P101
 - "Searching by title number" P101
 - "Searching by menu number" P102

- To change the display of touch switches
 - "Changing the touch switch display locations" P103

- To change subtitles, audio or the video angle
 - "Changing the angle" P104
 - "Switching subtitle language" P105
 - "Switching dubbed audio language" P106

■ To set the player	
"Setting the audio language"	P108
"Subtitle language settings"	P109
"Menu language settings"	P110
"Setting the display of the multi-angle mark (angle selection mark)"	P111
"Viewer restriction settings"	P112
"Changing video output"	P113
■ To use the VTR	
"How to use the VTR"	P116

About using optional 5.1 ch decoder/AV matrix unit

■ To adjust sound quality	
● To adjust parametric equalizer	
"Adjusting PEQ (Parametric equalizer)"	P127
● To measure frequency characteristics	
"Measuring/Displaying frequency characteristics"	P130
● To switch the sound image localization to match the position of passengers	
"Adjusting POS (Positioning selector)"	P132
● To adjust the left/right/front/rear balance	
"Setting the balance"	P133
● To adjust the MP3/WMA sound	
"Setting the harmonizer"	P134
● To add sharpness when listening at low/high volume	
"Setting LOUDNESS"	P134
● To adjust the surround system	
"Setting/Adjusting the surround system"	P135
● To set the speakers	
"Setting/Adjusting the speakers"	P139
● To import sound quality data	
"Importing sound data"	P150

Topic index

- To set the display
- To set an external monitor image
 - "External monitor image settings" P151
- To play a portable audio player
 - "Listening to AUX" P152

When something isn't clear

- When you don't understand a screen message
 - "If one of these messages appears" P154
- When you think the deck may have a problem
 - "Before asking for repairs" P156

6. Index

A

Adjusting the main volume.....	27
Adjusting sound quality.....	28
ANGLE.....	104
AUTO.P.....	59

B

BRIGHT.....	53
-------------	----

C

CD-R (CD-Recordable).....	18
CD-RW (CD-ReWritable).....	18
COLOR.....	53
CONTRAST.....	53

D

Daytime display.....	51
DISC RAND.....	90
DISC RPT.....	89

E

EQ.....	31
---------	----

H

HOME.....	75
How to use the AM/FM radio.....	56
How to use the CD changer.....	88
How to use the CD player.....	68
How to use the DVD player.....	97
How to use the Memory Stick player.....	84
How to use the MP3 player.....	72
How to use the VTR.....	116

M

Multi-angle mark.....	104
-----------------------	-----

N

Nighttime display.....	51
NORMAL mode.....	54

P

PEQ.....	127
POS (position selector).....	34, 132

R

RAND.....	70, 76, 87, 90
RPT.....	70, 76, 86, 89

S

Saving radio stations.....	59
Setting LOUDNESS.....	36, 134
Setting the BEEP tone.....	27
Switching dubbed audio language.....	106
Switching subtitle languages.....	105

T

TINT.....	53
Turning the screen off.....	52

V

Volume balance.....	35, 133
VOLUME button.....	27

W

Wallpaper (background).....	39
WIDE 1 mode.....	54
WIDE 2 mode.....	54
WIDE 3 mode.....	54

MEMO